

NYPL RESEARCH LIBRARIES



3 3433 08179227 1



7-1A
Wilson



Digitized by the Internet Archive
in 2008 with funding from
Microsoft Corporation



A HISTORY OF
THE AMERICAN PEOPLE

BY
WOODROW WILSON, PH.D., LITT.D., LL.D.

IN FIVE VOLUMES

VOL. IV.

Critical Changes and Civil War

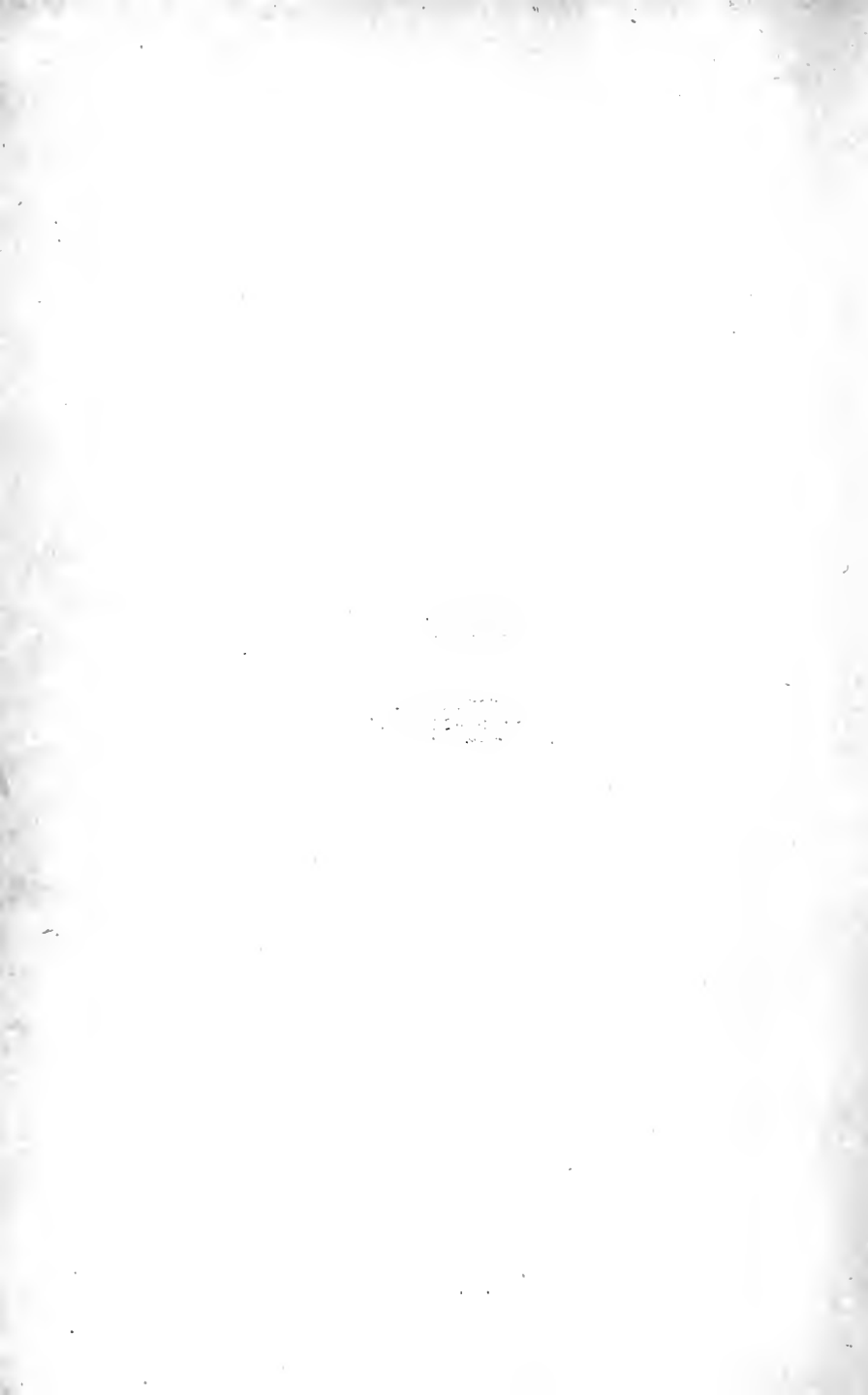

THE NEW YORK
PUBLIC LIBRARY

ASTOR, LENOX
TILDEN FOUNDATIONS

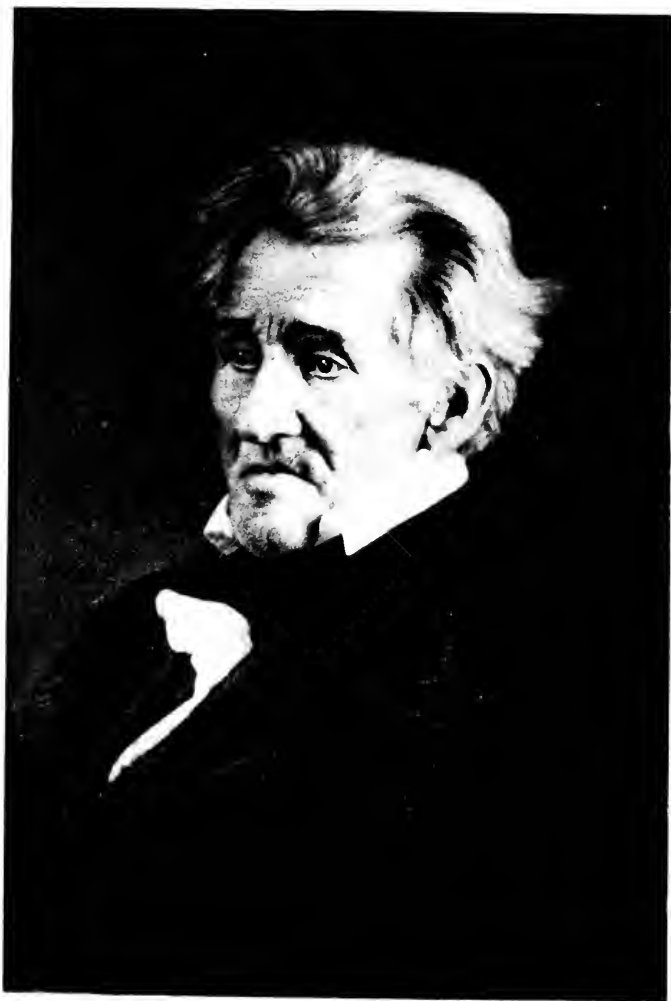

Andrew Jackson

A HISTORY OF THE AMERICAN PEOPLE

BY

WOODROW WILSON, PH.D., LITT.D., LL.D.

PRESIDENT OF PRINCETON UNIVERSITY

ILLUSTRATED WITH PORTRAITS, MAPS
PLANS, FACSIMILES, RARE PRINTS
CONTEMPORARY VIEWS, ETC.

IN FIVE VOLUMES

VOL. IV.



NEW YORK AND LONDON
HARPER & BROTHERS PUBLISHERS
MCMIII

1292787

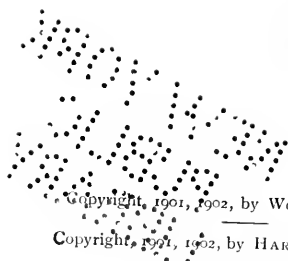

Copyright, 1901, 1902, by WOODROW WILSON.

Copyright, 1901, 1902, by HARPER & BROTHERS.

All rights reserved.

CONTENTS

CHAPTER	PAGE
I. THE DEMOCRATIC REVOLUTION	I
II. THE BANK AND THE TREASURY	41
III. THE EXTENSION OF SLAVERY.	88
IV. ARMED DIVISION	145
V. THE CONFEDERATE STATES	265
APPENDIX	313

NOTES ON ILLUSTRATIONS

	PAGE
ANDREW JACKSON (<i>photogravure</i>).—From Higginson's <i>History of the United States</i>	Frontispiece
HENRY CLAY AT THE AGE OF FORTY-THREE.—From a portrait by Mathew H. Jouett	2
ROBERT FULTON.—From a portrait by Benjamin West, painted in 1805	4
FULTON'S FIRST STEAMBOAT.—Redrawn from an old print	6
GENERAL ANDREW JACKSON.—From a portrait in the City Hall, New York, painted by John Vanderlyn in 1819, when Jackson was fifty-two years of age	8
CARPENTERS' HALL, PHILADELPHIA.—From a photograph	11
MARTIN VAN BUREN.—From a portrait by Henry Inman, in the possession of W. Duer, Esq.	13
JAMES KENT.—Redrawn from an old print	15
JEREMIAH MASON.—Redrawn from an old print	17
MODEL OF THE JOHN STEVENS LOCOMOTIVE. THE FIRST IN AMERICA. 1825.—Redrawn from an old print	20
MODEL OF THE STOCKTON AND DARLINGTON LOCOMOTIVE. BROUGHT FROM ENGLAND. 1826.—Redrawn from an old print	22
DANIEL WEBSTER.—From a daguerrotype in the possession of Charles Lanman, Esq.	24
ROBERT YOUNG HAYNE.—From an engraving after a drawing by J. B. Longacre	26

NOTES ON ILLUSTRATIONS

	PAGE
TITLE-PAGE OF SPEECH OF DANIEL WEBSTER.—From the original in the New York Public Library (Lenox Building)	29
THE DE WITT CLINTON TRAIN WHICH RAN IN 1830 BETWEEN ALBANY AND SCHENECTADY.—Photographed from the original locomotive and carriages by A. P. Yates, official photographer of the New York Central Railroad	31
DANIEL WEBSTER.—From the painting by G. P. A. Healy, now in Faneuil Hall, Boston, Mass. <i>Facing p.</i>	32
BELL'S STEAMBOAT COMET, 1812.—Redrawn from an old print	33
FREIGHT AND PASSENGER CARS, 1848.—From an old print .	36
THE FIRST CAPITOL OF TEXAS.—Redrawn from an old print	38
THE OLD UNITED STATES BANK, NOW THE CUSTOM HOUSE, PHILADELPHIA.—From a photograph	42
ALEXANDER H. STEPHENS.—From a photograph by Brady	45
NICHOLAS BIDDLE.—Engraved by J. B. Longacre and T. B. Walsh after a painting by Rembrandt Peale	50
ROGER B. TANEY.—From Coffin's <i>Life of Lincoln</i>	55
LOUIS MCLANE.—Redrawn from an old print	57
ELECTORAL TICKET OF 1836.—From a photograph from the original ticket	60
A NORTH CAROLINA MANSION OF THE OLD STYLE.—From <i>Harper's Encyclopaedia of United States History</i>	63
JOHN C. CALHOUN.—From the painting by De Bloch, in the possession of John C. Calhoun, Esq. <i>Facing p.</i>	64
SILAS WRIGHT, JR.—From an engraving after a daguerrotype by Brady	67
SAM HOUSTON.—Redrawn from an old print	69
CYRUS HALL MCCORMICK.—Reproduced from an engraving kindly loaned by the McCormick Company of Chicago .	71
JOHN GREENLEAF WHITTIER.—From an engraving by Wilcox after a daguerrotype	73

NOTES ON ILLUSTRATIONS

	PAGE
EDGAR ALLAN POE.—From <i>Harper's Monthly Magazine</i> . . .	75
WILLIAM H. PRESCOTT.—From an old stipple engraving . . .	77
RALPH WALDO EMERSON.—From a photograph by Black . . .	79
JAMES RUSSELL LOWELL.—Redrawn from an engraving after a daguerrotype	81
NATHANIEL HAWTHORNE.—From Howells's <i>Literary Friends and Acquaintance</i>	83
HENRY W. LONGFELLOW.—From an old print	84
PRESIDENTIAL TICKET, 1840.—From a photograph of the original ticket	85
WILLIAM HENRY HARRISON.—From Lossing's <i>Field-Book of the War of 1812</i>	86
CAMPAIGN NEWSPAPER. EDITED BY HORACE GREELEY. —From the original in the New York Public Library (Lenox Building)	opp. 86
JOSEPH STORY.—From an engraving after a portrait by Chester Harding	89
CAMPAIGN SYMBOL OF 1840. — Redrawn from a copy of the campaign cartoon	93
JOHN TYLER.—Redrawn from an engraving from a daguerro- type	95
THE HANCOCK HOUSE, BOSTON. — Redrawn from a sketch made in 1833. Showing rail-fence around the Boston Com- mon, which was used originally as a cow pasture	97
TITLE-PAGE OF ANTI-ABOLITION PAMPHLET.—From Sparks's <i>The Men Who Made the Nation</i>	99
BROADWAY, EAST SIDE, BETWEEN GRAND AND HOWARD STREETS, NEW YORK, 1840.—From an old lithograph . . .	103
GENERAL SANTA ANNA.—Redrawn from an old print . . .	106
WENDELL PHILLIPS.—From a photograph	109
TITLE-PAGE OF A CAMPAIGN PAMPHLET.—From the orig- inal in the New York Public Library (Astor Building) . . .	111

NOTES ON ILLUSTRATIONS

	PAGE
HENRY CLAY.—From a drawing by Davignon <i>Facing p.</i>	112
TITLE-PAGE OF "THE CLAY SONGSTER."—From a photograph from the original	113
JAMES K. POLK.—Redrawn from an old print	116
ZACHARY TAYLOR.—From an old lithograph	119
WINFIELD SCOTT.—From an engraving after a daguerrotype	121
THE DEPARTURE OF THE PHILADELPHIA VOLUNTEERS FROM PHILADELPHIA.—From a humorous drawing by F. O. C. Darley	123
CHARGE OF THE "PALMETTOS" AT CHURUBUSCO.—From a drawing by Döpler, in <i>Harper's Monthly Magazine</i>	125
MAIN STREET IN AUSTIN, TEXAS, ABOUT 1845.—Redrawn from an old print	126
SALMON PORTLAND CHASE.—From <i>Harper's Monthly Magazine</i>	127
LEWIS CASS.—From <i>Harper's Monthly Magazine</i>	129
THOMAS WILSON DORR.—Redrawn from an old print	130
SAN FRANCISCO, CALIFORNIA, IN 1848.—Redrawn from an old print	131
ENGLISH POWER LOOM FOR WEAVING COTTON, 1847.—Redrawn from an old print	133
CASTLE GARDEN, NEW YORK, IN 1850.—From <i>Harper's Monthly Magazine</i>	135
EMIGRANT TRAIN CROSSING THE PLAINS.—Redrawn from an old print	136
A TYPICAL HOTEL IN THE MIDDLE MINES, CALIFORNIA, ABOUT 1850.—From a sketch from nature by A. V. S. Anthony	137
SLUICE WASHING FOR GOLD IN THE MIDDLE MINES, CALIFORNIA, ABOUT 1850.—From a sketch from nature by A. V. S. Anthony	139
OLD SPANISH FORT AT MONTEREY, CALIFORNIA, IN 1848.—From <i>Harper's Monthly Magazine</i>	141

NOTES ON ILLUSTRATIONS

	PAGE
TITLE-PAGE OF A CONTEMPORARY PAMPHLET.—From Sparks's <i>The Men Who Made the Nation</i>	149
MARTIN VAN BUREN.—From a portrait by Daniel Huntington, painted for Mr. Van Buren and presented by him to a collection of notable statesmen now in the State Library at Albany, New York	155
FRANKLIN PIERCE.—Redrawn from an old print	158
TITLE-PAGE OF "UNCLE TOM'S CABIN"—From a copy of the first edition of the work	161
COVER OF PAMPHLET ON THE BOSTON SLAVE RIOT.—From the original in the New York Public Library (Lenox Building)	163
WILLIAM H. SEWARD.—From a photograph by Brady	168
GEORGE GORDON MEADE.—From a photograph by Brady	171
PIERRE SOULÉ.—Redrawn from an old print	173
JOHN CHARLES FRÉMONT.—From an engraving after a photograph by Brady	175
STEPHEN A. DOUGLAS.—From a photograph by Brady <i>Facing p.</i>	176
GEORGE HENRY THOMAS.—From a photograph by Brady	177
JOSEPH ECCLESTON JOHNSTON.—From a photograph by Anderson	179
HARPER'S FERRY IN 1859.—From a sketch made in 1859 by a staff artist of <i>Harper's Weekly</i>	181
JOHN BROWN.—Redrawn from an old print	183
THE DUNKER CHURCH, WHERE JOHN BROWN PREACHED THE NIGHT OF THE RAID.—From a sketch furnished by Jeannie Chambers	184
COLONEL LEE'S MARINES BREAKING INTO THE ENGINE-HOUSE AT HARPER'S FERRY.—Drawn from a sketch by a staff artist of <i>Harper's Weekly</i>	187
FACSIMILE OF LINCOLN'S LETTER OF ACCEPTANCE.—From Nicolay and Hay's <i>Life of Lincoln</i>	189

NOTES ON ILLUSTRATIONS

	PAGE
MR. SEWARD'S SUGGESTION FOR THE CLOSE OF MR. LINCOLN'S INAUGURAL ADDRESS.—From Nicolay and Hay's <i>Life of Lincoln</i>	191
CLOSING PARAGRAPH, IN MR. LINCOLN'S HANDWRITING, OF THE INAUGURAL ADDRESS.—From Nicolay and Hay's <i>Life of Lincoln</i>	191
JAMES BUCHANAN.—From a photograph	193
ALBERT SIDNEY JOHNSTON.—Redrawn from an old print	195
THE "GEORGE WASHINGTON" LOCOMOTIVE, 1835.—Redrawn from an old print	199
VICKSBURG, MISSISSIPPI, 1863.—From a sketch made during the Rebellion	201
A SNAG BOAT ON THE MISSISSIPPI RIVER.—Redrawn from an old photograph	203
LINCOLN MAKING HIS FIRST INAUGURAL ADDRESS.—From a sketch made by a staff artist of <i>Harper's Weekly</i>	205
FORT SUMTER ON NOVEMBER 10, 1863.—From a sketch made at the time	206
INTERIOR OF FORT SUMTER AFTER THE BOMBARDMENT, DECEMBER, 1863.—From a war-time sketch	209
FORT SUMTER, AS REBUILT.—From a photograph	211
SERGEANT HART NAILING THE COLORS TO THE FLAG-STAFF, FORT SUMTER.—From <i>Harper's Encyclopaedia of United States History</i>	213
DAVID DIXON PORTER.—From a photograph by C. M. Bell	215
SIGNATURES OF THE COMMISSIONERS OF VIRGINIA AND THE SOUTHERN CONFEDERACY.—From <i>Harper's Encyclopaedia of United States History</i>	217
THE OSAGE, TYPE OF IRON-CLAD USED ON THE MISSISSIPPI RIVER.—From a war-time photograph	219
THE CHICKASAW, TYPE OF IRON-CLAD USED ON THE MISSISSIPPI RIVER.—From a war-time photograph	220
THE DE KALB, TYPE OF IRON-CLAD USED ON THE MISSISSIPPI RIVER.—From a war-time photograph	221

NOTES ON ILLUSTRATIONS

	PAGE
PIERRE GUSTAVE TOUTANT BEAUREGARD.—From a photograph by Sarony	223
A CALL FOR REINFORCEMENTS.—From <i>Battles and Leaders</i>	225
GEORGE BRINTON MCCLELLAN.—From a photograph by Conly	227
MILLARD FILLMORE.—From a photograph by W. Baker . .	230
FACSIMILE OF WAR SCRIP ISSUED BY THE CONFEDERATE LEGISLATURE OF MISSOURI.—From <i>Battles and Leaders</i>	233
STATUE OF FARRAGUT IN MADISON SQUARE, NEW YORK CITY.—From a photograph	235
JOHN ERICSSON.—From an old steel engraving	238
THE MONITOR.—From a war-time sketch	239
BATTLE OF FREDERICKSBURG. VOLUNTEERS CROSSING THE RIVER.—From a painting by C. S. Reinhart . . .	241
FACSIMILE OF THE FINAL EMANCIPATION PROCLAMATION OF JAN. 1, 1863.—Nicolay and Hay	244, 245, 246, 247
THE HARTFORD, FARRAGUT'S FLAG-SHIP.—From a war-time sketch	250
UNITED STATES SLOOP OF WAR KEARSARGE.—From a war-time sketch	253
WILLIAM TECUMSEH SHERMAN.—From a photograph by Charles L. Ritzmann	255
TABLE USED AT THE SURRENDER AT APPOMATTOX COURT HOUSE.—From <i>Harper's Encyclopaedia of United States History</i>	257
CHAIR USED AT THE SURRENDER AT APPOMATTOX COURT HOUSE.—From <i>Harper's Encyclopaedia of United States History</i>	258
JOHN WILKES BOOTH.—Redrawn from an old print . . .	260
THE WHITE HOUSE OF THE CONFEDERACY, RICHMOND.—From a photograph	266
JEFFERSON DAVIS.—From a photograph by W. W. Washburn	269

NOTES ON ILLUSTRATIONS

	PAGE
MONTGOMERY, ALABAMA, IN 1862.—Redrawn from a photograph	272
ABRAHAM LINCOLN.—From a photograph taken by McNulty in Indianapolis, in 1861 <i>Facing p.</i>	272
THOMAS JONATHAN JACKSON.—Redrawn from an old print	275
ROBERT EDWARD LEE.—From the steel engraving published by the Lee Memorial Association for the Erection of a Monument at the Tomb of General Robert E. Lee at the Washington and Lee University, Lexington, Va. <i>Facing p.</i>	276
THE SHELL ROAD, MOBILE.—From a drawing by W. H. Gibson	277
ARLINGTON, THE RESIDENCE OF GENERAL ROBERT E. LEE.—From a sketch by Benson J. Lossing in 1850	279
WILLIAM LOWNDES YANCEY.—Redrawn from an old print	280
THOMAS R. R. COBB.—From a photograph in possession of President Woodrow Wilson, Princeton, N. J.	283
✓ FIRST PAGE OF THE ORIGINAL DRAFT OF THE CONSTITUTION OF THE CONFEDERATE STATES.—In the handwriting of General Thomas R. R. Cobb	285
ANDREW JOHNSON.—From an old photograph	287
CHATTANOOGA, TENNESSEE, IN 1862.—From a war-time sketch	291
A STREET HUCKSTER IN RICHMOND, VIRGINIA.—A sketch from nature by W. L. Sheppard	293
SELLERS OF FIREWOOD IN RICHMOND, VIRGINIA.—A sketch from nature by W. L. Sheppard	295
A SUPERANNATED DARKY IN RICHMOND, VIRGINIA.—A sketch from nature by W. L. Sheppard	297
A CALL FOR VOLUNTEERS IN ILLINOIS.—From a photograph from the original poster	299
A SELLER OF RABBITS AND HARES, RICHMOND, VIRGINIA.—From a sketch from nature by W. L. Sheppard	301
A WOOD PEDDLER, RICHMOND, VIRGINIA.—From a sketch from nature by W. L. Sheppard	303

NOTES ON ILLUSTRATIONS

	PAGE
FACSIMILE OF MR. LINCOLN'S AUTOGRAPHIC COPY OF THE GETTYSBURG ADDRESS, MADE BY HIM FOR THE SOLDIERS' AND SAILORS' FAIR AT BALTIMORE, IN 1864. —From Nicolay and Hay's <i>Life of Lincoln</i>	308, 309

LIST OF MAPS

TERRITORIAL ACQUISITIONS OF THE UNITED STATES, 1783-1853	<i>Facing p.</i> 28
TERRITORIAL CONTROVERSIES OF THE UNITED STATES, SETTLED BETWEEN 1783-1850	<i>Facing p.</i> 80
THE UNITED STATES, MARCH 4, 1855	" 170
SLAVERY IN THE UNITED STATES, 1775-1865	" 208



A HISTORY
OF THE AMERICAN PEOPLE



A HISTORY OF THE AMERICAN PEOPLE

CHAPTER I

THE DEMOCRATIC REVOLUTION

GENERAL JACKSON'S friends had reason to be satisfied. The effect they had wrought was indeed dramatic, revolutionary. They had cut a line of cleavage between epoch and epoch in the history of the country. They had broken, once for all, the "Virginian dynasty," "the succession of Secretaries," the leadership of trained and trusted men; had set aside every tradition of national politics; and had begun the administration of the executive office of the Union afresh upon their own plan. They had not, indeed, won secure control of either house of Congress. Parties were not fixed enough as yet for that. There were not a few "Democrats" who still retained a covert liking for the liberal construction their opponents put upon the constitution, and who upon occasion wavered in their votes, or incontinently went over to the ranks of the "National Republicans," whom Mr. Clay led. In the Senate there could be found, upon most questions, a majority against the new President. But the whole

A HISTORY OF THE AMERICAN PEOPLE

atmosphere of affairs, the whole tone of the government changed, nevertheless, with the coming in of General Jackson. The new nation, its quality subtly



HENRY CLAY

altered, its point of view insensibly shifted by the movement into the West, had smiled with some degree of patient complacency upon Mr. Monroe, and had endured John Quincy Adams, but now for the first time chose after its own kind and preferred General Jackson.

THE DEMOCRATIC REVOLUTION

It was a second democratization of the government. And yet it differed radically from the first, which Mr. Jefferson had so shrewdly contrived. There was no kinship either in spirit or in method between Mr. Jefferson and this new hero of democracy. Mr. Jefferson had, indeed, expressed the greatest alarm "at the prospect of seeing General Jackson President." "He is," he said, "one of the most unfit men I know of for the place. He has had very little respect for laws or constitutions, and is, in fact, an able military chief. His passions are terrible. He has been much tried since I knew him, but he is a dangerous man." And had Mr. Jefferson lived to witness the result, he would hardly have altered his judgment. He had stood, for all he was so full of democratic doctrine, for conservative ways of political growth. General Jackson stood, it turned out, for personal government, party proscriptions, and the self-willed choices of personal power.

General Jackson professed to be of the school of Mr. Jefferson himself; and what he professed he believed. There was no touch of the charlatan or the demagogue about him. The action of his mind was as direct, as sincere, as unsophisticated as the action of the mind of an ingenuous child, though it exhibited also the sustained intensity and the range of the mature man. The difference between Mr. Jefferson and General Jackson was not a difference of moral quality so much as a difference in social stock and breeding. Mr. Jefferson, an aristocrat and yet a philosophical radical, deliberately practised the arts of the politician and exhibited oftentimes the sort of insincerity which subtle natures yield to without loss of essential integrity. General Jackson was incapable of arts or deceptions of any kind. He

was in fact what his partisans loved to call him, a man of the people, of the common people. Mr. Jefferson was only a patron of the people: appealed to the rank and file, believed in them, but shared neither their tastes



Robert Fulton

ROBERT FULTON

nor their passions. Moreover, the effective rank and file of the nation had changed since his day of ascendancy. Step by step, one State following another, the old restrictions upon the suffrage, taken for granted in Jefferson's time, had been removed, until in almost every part of the Union the men of the masses had be-

THE DEMOCRATIC REVOLUTION

come the stuff of politics. These men Jackson really represented, albeit with a touch of the knight and chivalrous man of honor about him which common men do not have; and the people knew it; felt that an aristocratic order was upset, and that they themselves had at last come to their own.

It must have seemed so in very fact at their President's inauguration. Washington filled with crowds come out of every quarter of the Union. All ceremony was overridden, all decorum cast aside. It seemed as if the place were in the possession of a good-natured mob, bent upon no serious mischief, but not to be restrained, not to be forbidden even the drawing rooms of the White House or the committee rooms and chambers of the Capitol. There was scarcely room enough in the streets for the passage of the procession which accompanied General Jackson to the place of inauguration. So great a crowd rushed, unbidden, into the White House, when General Jackson came to it from the Capitol, that he was himself forced against the wall of the reception chamber by its pressure, and was secured against serious danger only by a number of gentlemen linking arms and forming themselves into a barrier. "Everywhere it was proclaimed that the people had come into possession of the government; that the domination of professional statesmen and politicians had been thrown off: that the rank and file were the victors, and that to the victors belonged "the spoils of the enemy."

That was unquestionably General Jackson's creed. Men who understood him could play upon him. He had allowed ill-informed men who believed it, and designing men who pretended to believe it, to persuade him that the government had not only been monopolized

A HISTORY OF THE AMERICAN PEOPLE

but also corrupted by the politicians and statesmen who had hitherto controlled it; and he meant to purify it very radically. Among his advisers were men, like Mr. Martin Van Buren, of New York, who were past-masters in the art of party organization, and whose methods he willingly adopted for the establishment of the national power of his followers. They were methods which he could readily understand, and which seemed almost to fall within his own experience. He

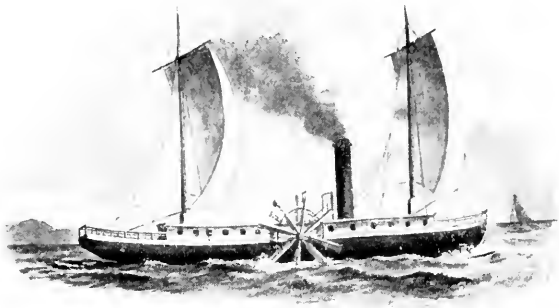

FULTON'S FIRST STEAMBOAT

was a frontier soldier. Staunch comradeships, personal devotion, the close, unhesitating cohesion of friends, the intimate co-operation of men who knew and trusted one another by reason of joint efforts in a common affair, seemed to him the natural and proper basis for the discipline of a party no less than for the discipline and success of a frontier levy of volunteers. He knew and cared nothing for the orderly promotions of a regular service.

The suffrage had been thrown open in New York, as elsewhere, and Mr. Van Buren had become one of

THE DEMOCRATIC REVOLUTION

a small group of astute men there who had supplied the new voters, crowding without concert to the polls, with the organization they could not contrive for themselves. These "Albany regents," as their opponents dubbed them, had effected their propaganda and their nominations, through local caucuses, and through conventions composed of delegates whom the caucuses selected. The lieutenants whom they used to assist them in organizing the caucuses, superintending the selection and the business of the conventions, and looking after every local detail of party action, they rewarded when they could with offices and nominations for themselves. It was this association of men who stood by one another and served one another as personal allies and friends that won the admiration of General Jackson. "I am no politician," he said; "but if I were one, I would be a New York politician." Pennsylvania politics were of the same sort: the politics of intimate personal association. There, too, democracy on the great scale had submitted to the same organization, the same leadership of consummate, watchful managers. It was the new organization of democracy. General Jackson both understood and relished it. He saw nothing immoral in the promise that when he came into office he would reward his friends and punish his enemies. That, on the contrary, was a fundamental first principle of morals on the frontier. He firmly believed his friends to be the friends also of the government,—of the government as it had been and ought to be; his enemies, enemies of the government as well. The earnestness and sincerity with which he believed it, the frankness with which he avowed the belief, were interesting proofs of his conscious in-

A HISTORY OF THE AMERICAN PEOPLE

tegrity. With all the intensity of his nature he wished for the welfare of the country, the advancement of the



GENERAL ANDREW JACKSON

Union, the success and permanency of its government; with all the terrible force of his will he purposed to secure both the one and the other. No doubt he had shown

contempt for law, as Mr. Jefferson said, when he was upon the frontier, hampered by treaties and instructions; but his ideals were not those of the law-breaker. They were those of the ardent patriot. The peril of the country lay in the fact that he chose to disregard precedent and to interpret all laws for himself,—the law of the constitution no less than the law of the statute book.

And so there was almost a clean sweep of the federal offices to make room for General Jackson's friends, and secure proper persons to execute General Jackson's purposes. That the men dismissed had been long in office he deemed an additional argument for their discharge rather than an argument for their retention. Long terms of service he thought undemocratic. They slackened diligence, he believed, and made office-holders too carelessly secure. No doubt they fostered corruption, too. He did not himself conduct the proscription; he let those whom he trusted conduct it in his name. By the time the first Congress of his term assembled (December 7, 1829) it was estimated that fully a thousand federal officials had been removed, as against seventy-three at the most in all the previous history of the government. The Senate tried to stay the tide where it could, in its action on the nominations sent to it; but found the President imperious, irresistible, not to be gainsaid, and public opinion out-of-doors astonishingly ready to support and applaud him at every turn of the contest. "We give no reasons for our removals," said Mr. Van Buren; and apparently the mass of the voters wanted none. They were content to know that General Jackson was changing the government from top to bottom. Men without parts

or reputation of course got into office, in the general scramble. There could be little choice or deliberation in that wholesale process. The men appointed were for the most part men who had put themselves forward. There were very few men of any experience at all in federal administration, and many adventurers, to be found in the ranks of the new party. "Very few reputable appointments have been made," Mr. Adams, the ruthless General's predecessor in office, set down in his journal, "and those confined to persons who were indispensably necessary to the office." "The appointments are exclusively of violent partisans, and every editor of a scurrilous and slanderous newspaper is provided for."

It was only fair to remember that the new party drew of necessity upon its ranks, whether for ordinary officials or for leaders. If the minor office holders were new men, so were their chiefs also, who stood close about the President himself. The cabinet which General Jackson chose seemed conventional enough, indeed, for a party so recently made up. Mr. Van Buren had left the office of Governor of New York to become Secretary of State. He had been merely a local politician, no doubt, though he had served a term in the Senate, and had come but the other day into national prominence; but he was at least as well known as many another cabinet officer before him. The other heads of Departments, though even less generally known to the nation than he was, had played a public part in affairs, in Congress and out of it, and had been chosen for reasons familiar enough in politics. Major John H. Eaton, of Tennessee, was selected to be Secretary of War, because he was a trusted personal friend of the President's;

THE DEMOCRATIC REVOLUTION

the Secretaries of the Treasury and of the Navy and the Attorney General owed their places to the fact that they were the friends of Mr. Calhoun, the Vice President, who stood at the front of the President's party in the South. The Postmaster General had been a candidate for the governorship of Kentucky in the Jackson in-



CARPENTERS' HALL, PHILADELPHIA

terest, and had been defeated by a nominee of the friends of Mr. Clay.

What was really singular and significant was, that these gentlemen did not, under General Jackson, form a real cabinet at all. The country presently learned that the President did not hold cabinet meetings: that he took counsel, when he felt in need of it, with private friends, some of whom had no recognized post or stand-

ing in the government at all. Chief among these were one William B. Lewis, of Tennessee, a kinsman and neighbor of General Jackson's, and one Amos Kendall, a Massachusetts man now identified with Kentucky. It was Major Lewis who, more than any other man, had first forced him into candidacy for the presidency, who had set the stage for him at every turn of his political career, who had set afoot, superintended, fomented, and with an infinite art and diligence brought successfully to a head the many influences, public and private, which were to bring him finally into office and to the leadership of his party. General Jackson consulted and used him without in the least realizing that he had in him a consummate master of the arts whereby opinion is made and individual men are set forward in their ambition. He had made Major Lewis Second Auditor of the Treasury; but Lewis was not a man who played for himself. He played for Jackson, and loved every subtle turn of the game: used his gifts of management like one who played for his own hand, and yet remained a man of honor and served his friend more than he served himself. Amos Kendall was a master of the art political, not in action, but upon paper. He had gifts as a writer which could be turned to account in the composition of the most serious state papers. He caught the impressive tone of public business and mastered its calm way of reasoning as readily as he caught the tones of partisan controversy and spent his force in its bitter energy. He could frame a significant innuendo or prepare an editorial for the party press that bit as deep as anything that Tom. Paine or William Cobbett could have written. He seemed a statesman or a mere partisan by turns; it was difficult to

THE DEMOCRATIC REVOLUTION

tell which he was either by nature or by choice. He was perhaps each in turn; but nothing out of the closet.

There were others of the "Kitchen Cabinet" besides: the editors of Jacksonian newspapers; but the heart



MARTIN VAN BUREN

of it lay in Major Lewis and Mr. Kendall. Mr. Van Buren and Major Eaton, of Tennessee, the Secretary of War, were freely admitted into this inner circle; but not as members of the cabinet, only as personal friends and confidants of the President.

And so a veritable personal government was set up, so far as the Executive and the discipline of the Executive's friends in Congress were concerned; and allegiance to General Jackson became the test of fidelity for every Democrat who wished to be admitted to the party's counsels. The President's mere audacity won many men to him, for the masses of the country loved bold individual initiative. His rugged honesty, his sincerity, his own power of devotion, his frank friendliness, his confiding faith in his friends won more. Towards women he showed the gracious, deferential courtesy of the man who would be every woman's knight and champion. Foreign ministers who had expected to find in him the rough frontiersman were amazed at his natural dignity and ease, the air almost of elegance and of majesty that hung about him because of his quiet self-respect, his grave and unaffected courtesy, and the striking sadness and reserve of his deep-set eyes. No President since Washington had so taken hold upon the imagination, and every month he remained in office his ascendancy became the more assured.

It made a startling difference to the country. It broke the course of all settled policy, forced every question to square itself with the President's standards, altered the elements of parties. The country got its first taste of the effect to be wrought upon policy in connection with the troublesome question of the removal of the Indians from Georgia and Alabama to lands beyond the Mississippi. Georgia had got rid of the Creek Indians while Mr. Adams was President. Both Creeks and Cherokees held their Georgia lands under treaties with the United States such as the constitution explicitly authorized the President to negotiate; the

THE DEMOCRATIC REVOLUTION

Creeks had relied upon the treaties and steadfastly refused to sell their lands or suffer themselves to be driven out of the State; and Mr. Adams had sought by every means in his power to protect them. But



James Kent

JAMES KENT

Congress had supported him very lukewarmly, and Georgia had succeeded at last in extorting from the unwilling chiefs of the tribe terms which put their people forth into the West, where Congress was ready to provide for them. The Cherokees were not to be so cajoled or dealt with. They mustered thirteen thousand strong;

had settled to the occupations and learned the arts of peace; boasted a system of self-government and of orderly obedience to their own laws which seemed to promise, not extinction or decay or any decline of their power, but a great development and an assured permanency; and would not entertain any proposition whatever which involved the sale or relinquishment of the rich lands they occupied. General Jackson, however, unlike his predecessor, thought the State ought to be rid of them. Georgia and Alabama, therefore, relying on his countenance, extended their laws over the Indian country in despite of treaties; the President, when Georgia requested him to do so, withdrew the federal troops stationed there; and the Indians were obliged to yield. "I informed the Indians inhabiting parts of Georgia and Alabama," the President told Congress in his first message, "that their attempt to establish an independent government would not be countenanced by the Executive of the United States, and advised them to migrate beyond the Mississippi or to submit to the laws of those States." Life on the frontier had left him no patience to consider the rights of red men.

Their rights were duly tested in the courts. Three several times was the matter taken, on appeal, to the Supreme Court of the United States, and each time the court decided the question submitted to it in favor of the Indians, upholding the treaties and denying the right of any State, or any authority whatever, to violate or ignore them. But General Jackson would not enforce its decisions. His attitude towards the Indians was frankly that of the frontier soldier. They had no right, in his eyes, to stand in the way of the

THE DEMOCRATIC REVOLUTION

white man. By the time the last of the decisions of the Supreme Court was rendered in the matter (1832)



J. Mason

JEREMIAH MASON

another presidential election was at hand and he was a candidate for re-election. He said that he would leave the question to the people,—such was his constitutional theory of right! The constitution did in-

A HISTORY OF THE AMERICAN PEOPLE

deed give the federal Executive the authority to negotiate treaties with the Indian tribes, and Congress the right to regulate commerce with them, as if they were to be treated in all respects like independent bodies politic, in no way subject to the jurisdiction of the separate States. But the constitution also explicitly commanded that no new State should be "formed or erected within the jurisdiction of any other State" without the express consent of the legislature of that State and of Congress; and the Cherokees were obviously in a fair way to create a virtually independent commonwealth within the State of Georgia should they remain. It was a nice point of law, which General Jackson should have recognized the right of the Supreme Court to decide. But with him his own judgment was more conclusive, and a vote of the people the solution of all doubts.

It was significant how quick the new democracy he stood for was to take fire against the courts and turn, by way of ultimate appeal, to the people in all things. In Mr. Jefferson's day also the courts had seemed the strongholds of Federalism, and the leaders of Congress had wished to see their judges removed at pleasure upon the address of the houses. Now they seemed again the barriers, the only barriers, set up against the people's will. Many an observant eye had remarked how dramatic a thing it was that General Jackson, like Mr. Jefferson, should take the oath of office from John Marshall, the steadfast champion of Federalist doctrine and of the reign of law under a constitution which was itself the supreme law of the land. When Mr. Jefferson took office John Marshall had but just come to his power, a man in his prime, the incoming President's junior by a dozen years. Now he was the new President's

THE DEMOCRATIC REVOLUTION

senior by as many years, though General Jackson, for all his erect and slender height, was a gray veteran of sixty-two. The aged Chief Justice was as straight at seventy-four as the soldier to whom he administered the oath of office, and bore his years as well; but General Jackson stood, his years notwithstanding, for a new age coming in, the aged judge for an old order passing away. The fire that shone in the eyes of the old soldier burned hot against the authority that sat upon the quiet brow of the aged lawyer.

In the very inaugural address which he uttered that day of his coming into office the grizzled President threw out his challenge to the court, and made bold to give it upon a matter of graver moment for the whole country than the rights of Indian tribes even and the sacredness of the treaties which gave them a standing in the court. He doubted, he gave the country to understand, whether Congress had acted within its constitutional powers in creating the Bank of the United States. That had once, as everybody understood, been a debatable question; but the Supreme Court had given judgment upon it in the celebrated case of *McCulloch vs. Maryland* (1819), in which it had explicitly affirmed the right, as drawn by just inference from the undoubted powers of Congress; and since then it had been deemed a question settled once for all. But General Jackson regarded no question as settled which altered circumstances could reopen. The twenty-year charter of the Bank was not to run out, indeed, until 1836, a year which lay beyond his term; but a reconsideration of it was to come. Apparently he had no intention of going now beyond a mere preliminary expression of opinion in the matter.

He simply put this forth as a companion thought to his declaration of the conviction that the surplus revenue of the federal government ought to be distributed among the States, not spent for objects, like internal improvements, which the constitution, in his opinion, gave Congress no authority to undertake or pay for. He was merely setting forth at the outset of his time of power, after his usual blunt, uncompromising fashion,

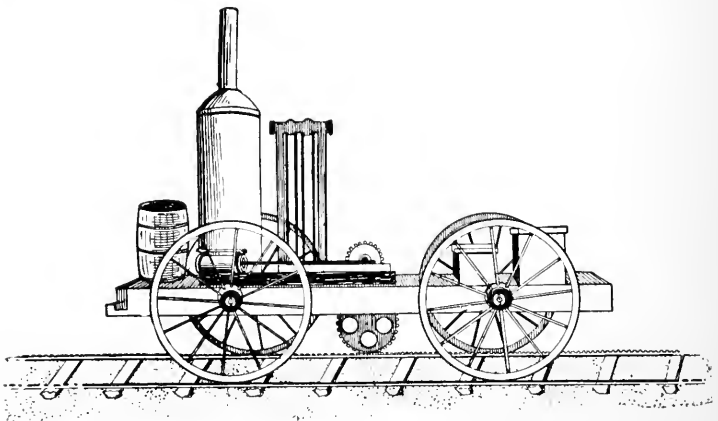

MODEL OF THE JOHN STEVENS LOCOMOTIVE. THE FIRST IN AMERICA.
1825

what he conceived to be the true democratic creed in matters of national finance. Other more pressing matters called for first attention, and for action.

These initial declarations of opinion and intimations of policy on the part of the President were eminently satisfactory to the men of the South and West whose candidate he had been. Here were the views of strict construction for which they had looked. In his very first message he solemnly warned Congress "against all encroachments upon the legitimate sphere of state

THE DEMOCRATIC REVOLUTION

sovereignty"; and conservative men, whose thought had been formed by Mr. Jefferson, drew about him with almost as much confidence as was shown by those who had the adventurous and aggressive spirit of the new age at their hearts and desired change.

But when the President was put to the test by the Carolinians for whom Mr. Calhoun had formulated the extreme doctrine of state rights, they suddenly saw him in another light. They then saw, what they might have seen at first, that he was of the West, not of the South. He stood, as all other western men did, for the principle that every community must have its own life in the free partnership it had formed, and its own unhindered, unbidden development, unchecked by the national government: for he believed that to be the end and object of the Union, to make the States secure of their individual development and set them forward in their own ways. But there was an infection of national feeling, too, upon the stirring frontier where he had been bred which no man could escape; a sense as of a people's life a-making upon a continental scale; an ardor for broad schemes and vast achievement, in bands united and backed by the nation's power. "The legitimate sphere of state sovereignty" did not, when projected there upon the prairies, encroach upon the equally legitimate sphere of the federal power. The two were inseparable parts of a single conception. No frontiersman reasoned subtly upon them: instinct and the spirit of conquest resolved all doubts and discountenanced all refinements. Argument was excluded. In any case General Jackson, as President, would have excluded it. To challenge the authority of the federal government now was to challenge his

own authority; and there need have been no doubt what he would do in that event.

The issue that was to be joined and settled was first drawn to the light, with painful vividness, by a debate in the Senate on the disposition of the western lands. The New England men wanted the settlement of the

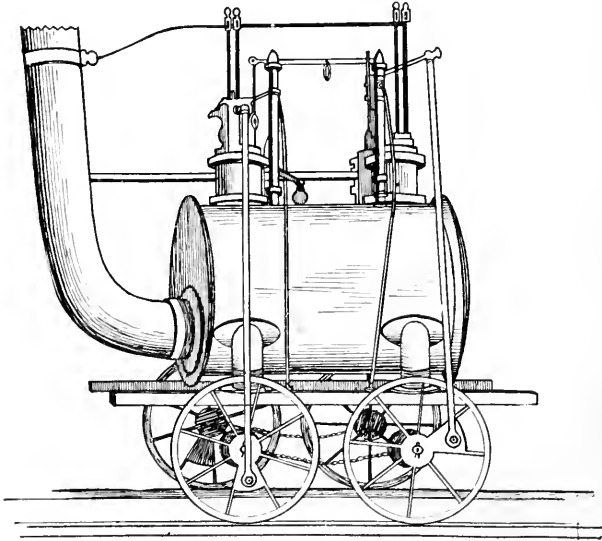

MODEL OF THE STOCKTON AND DARLINGTON LOCOMOTIVE.
BROUGHT FROM ENGLAND. 1826

West held back as much as possible. So long as land was to be had there almost for the mere asking, at no cost except that of the journey and of a few farmer's tools and a beast or two for the plough, the active men of their own section, whom they counted on as skilled workmen in building up their manufactures, must be constantly enticed away by the score and hundred, to seek an independent life and livelihood in the West;

high wages, very high wages, must be paid to keep them, if indeed they could be kept at all; and the maintenance of manufactures must cost more than even protective tariffs could make good. Here was an issue between East and West. The tariff itself was an issue between North and South, and drew after it, when read into the question of the western lands, no less a matter than the extension of slavery and the domination of sections in the politics of the country. Heavy tariffs, which fostered manufactures in the States where there were no slaves, insured growth of wealth and population in the East and North, but left the South to stand still and gain nothing. If her people could not go into the West and build up slave states there to make good the altering balance of power in the Union, they must look to see all things go steadily against them.

All these critical matters crept inevitably, as it seemed, into the debate on the western lands; and the country was aroused by it almost as it had been aroused ten years before by the debates on the admission of Missouri. It turned upon a resolution to limit the sales of the western lands which Mr. Foot, of Connecticut, introduced in the Senate late in December, 1829. Ordinary men could not have raised it to such a climax of interest; but the men engaged were not ordinary men. It was not Mr. Benton's hot protest that the men of New England should be always jealous of the growth and prosperity of the West that caught the ear of the country; it was the speeches of Mr. Hayne, of South Carolina, and Mr. Webster, of Massachusetts. The debate, as they handled it, swung abroad over the whole ground of the many closely related topics which lay upon the

borders of the immediate question it concerned. Mr. Hayne was of the extreme school of South Carolina, and took occasion to expound at length the doctrine of nullification which his colleagues in that school had



DANIEL WEBSTER

so lately perfected. It was out of the question, he said, that a State, when wronged by an exercise of federal power, should leave the decision of the matter of right entirely to the Supreme Court of the United States, part and organ of the very government whose power was challenged. The constitution was a compact, he maintained, the Union a free partnership; States

must stand ever upon the ground of the Kentucky and Virginia Resolutions and effect their own protection against deliberate and palpable excesses of power. Mr. Webster as fearlessly took the extreme ground of the opposite view. It was this splendid audacity on either side that quickened the pulses of all who listened, this hardy, intrepid pushing of the issue to its last analysis,—and that issue nothing less than the nation's destiny.

The debaters were already marked men. The Senator from South Carolina, though not yet forty, had won his laurels as a lad in the war of 1812, had been elected to the legislature of his State at twenty-three and made Speaker of its House at twenty-five; made his way as much by personal charm as by eloquence and a gift for business, had a grace and ardor in his speech which won all men's attention and liking, wore always the air of a man of honor and high spirit, and used his singular powers of persuasion with a fine force of conviction. Daniel Webster, his opponent, had first come into Congress from New Hampshire, as the war with England was drawing to a close (1813), and then, upon a change of residence, had been sent first to the House (1823), finally to the Senate (1827), from Massachusetts, and was now at forty-eight one of the most noticeable figures of the country, an orator and constitutional lawyer whose mastery every man acknowledged. Twice he had taken his stand, with a force of argument it would have been difficult to enhance, against protective tariffs; but, seeing his constituents deliberately and persistently stake their whole economic fortune as a community upon them, he at last had yielded, and was now the accepted champion of New England against

the violent onset of the South. He replied to Mr. Hayne that the constitution was no compact, the Union no mere dissoluble partnership, but a government, sovereign though not consolidated, a banded State which nothing

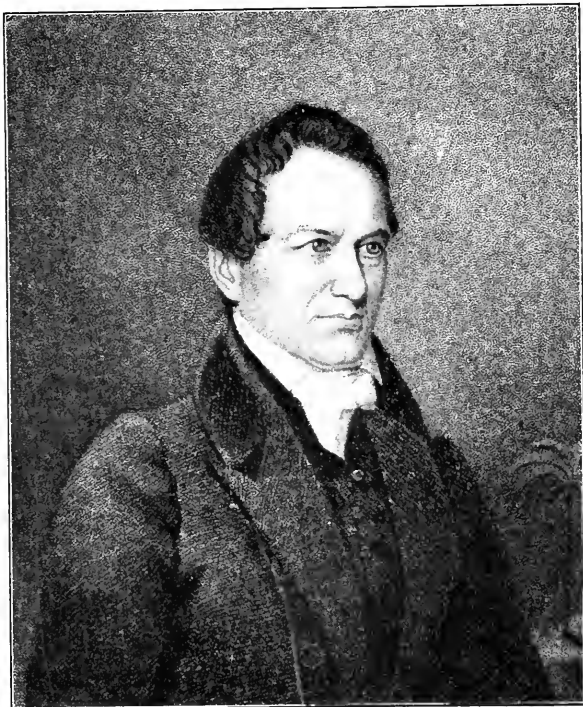

Robt Y. Hayne

ROBERT YOUNG HAYNE

but revolution could dissolve, its laws to be set aside or resisted only by acts of treason.

No such charm hung about the person of Mr. Webster as that which made Mr. Hayne so excellent an image of the courtly gentleman and the persuasive orator.

Alike in person and in utterance, Mr. Webster was compact, not of grace, but of force. Mr. Hayne's sentences rode high, upon rhetoric that sought often an adventurous flight; Mr. Webster used words as if he meant only to clarify and strengthen the thoughts he touched and cared nothing for cadence or ornament. And yet he spread them in ranks so fair that they caught and held the eye like a pageant. Beauty came upon them as they moved as if out of the mere passion of the thought rather than by the design of the orator. And he himself gave to the eye, as he stood, in his own person the same image of clean-cut strength, beautiful only by reason of its perfect action, so square was he, massive, and indomitable, and with a head and face whose mass, whose calm breadth above the deep-set, slumbrous eyes, seemed the fittest possible throne for the powers he displayed. There was imagination wrought into all that he said, but not the imagination of the rhetorician. Mr. Hayne's speech seemed to those who heard it worthy of the great reply it had called forth; but the country did not read it as it read what Mr. Webster had said. That was everywhere printed and read; and as the slow mails carried it forth it was as if the national spirit had suddenly been cried wide awake by its thrilling sentences. It was not the mere reasoner who won this triumph: reason was here touched with fire. The imagination of every man who could see the vision of a people united, indivisible, bound in sacred concord, was taken captive by these sonorous periods; the conviction of every man who saw the task and destiny of the nation as a whole was confirmed and heartened and made glad. There was magic in the printed words, as there was magic in the thrilling voice and

the magnificent presence of the man himself, in his massive stature and Olympian head, and in his eyes, burning dark with steady fire within their deep covert. There was no such magic in Mr. Hayne's speech: only the force of argument and of an able, clear-thinking man in earnest. Mr. Webster had taken new ground. The men of the first generation of federal statesmen had not spoken thus of the constitution, at whose conception and establishment they had been present. They had admitted that it was an experiment, though they had hastened at once to push it, if they could, beyond its experimental stage. No man had attributed treason to the authors of the Kentucky and Virginia Resolutions, whose language Mr. Calhoun and Mr. Hayne now revived. Every man who felt the power and the hope that were in the spirit of nationality as the men of the West did, as the constructive statesmen did who had stood with Washington and Hamilton in their generation, and with the young war enthusiasts who cried bravo to Mr. Madison in the war with England in theirs, protested very hotly when New England men talked of disunion, first because of the purchase of Louisiana, and then because of the embargo. But they protested, not as against rebellion; they protested as against mad folly, rather, and narrow selfishness: as against those who would mar a great history to push a sectional interest. Not until a whole generation had gone by from the making of the government did this new doctrine of nationality which Mr. Webster so eloquently and convincingly preached get its currency: this doctrine of a national existence based, not upon sentiment and agreement, but upon an imperative fundamental law.

THE NEW YORK
PUBLIC LIBRARY

ASTOR LENOX
TILDEN FOUNDATIONS

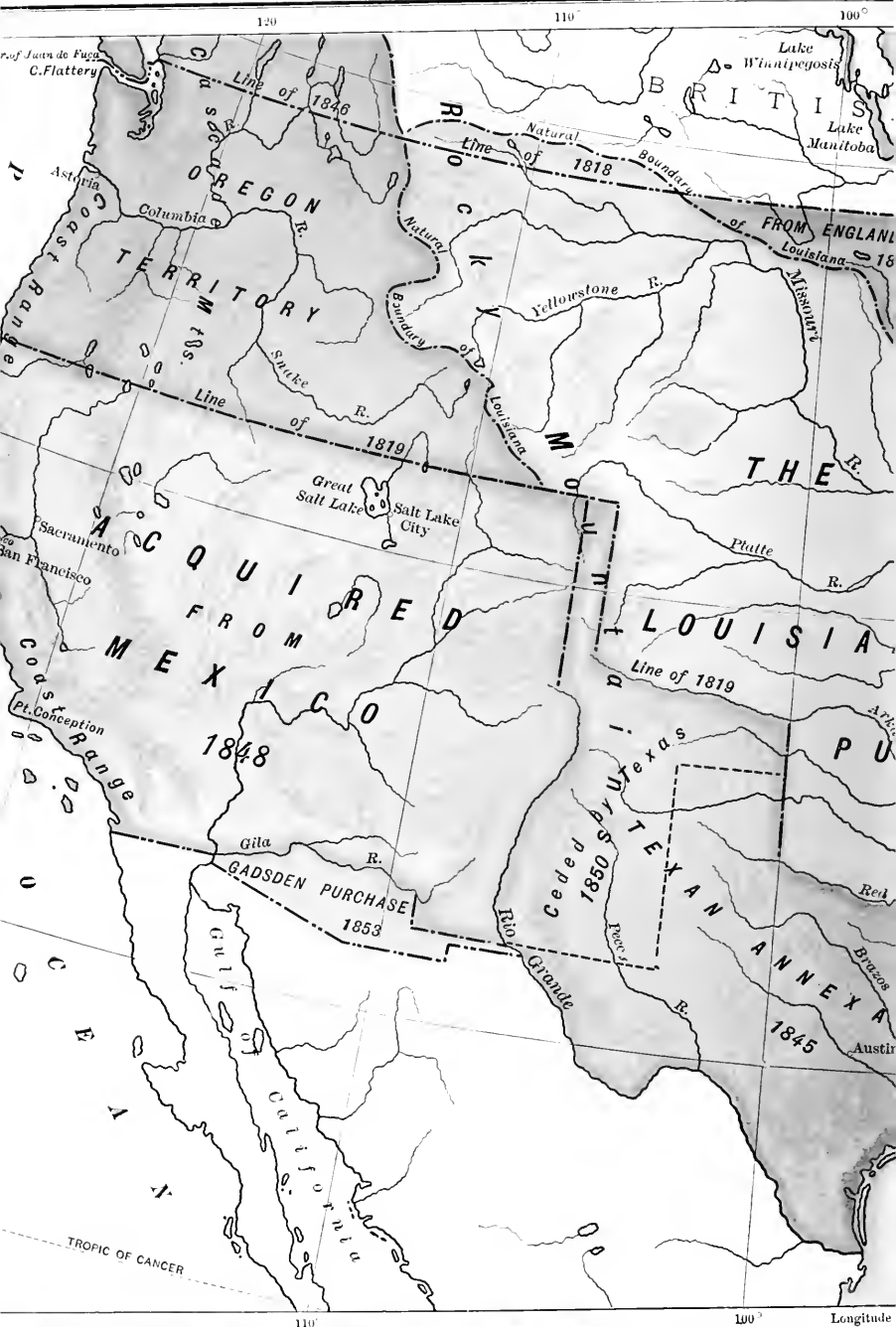

TERRITORIAL ACQUISITIONS OF THE UNITED STATES



THE NEW YORK
PUBLIC LIBRARY

ASTOR, LENOX
TILDEN FOUNDATIONS

SPEECH

OF

DANIEL WEBSTER,

IN REPLY TO

MR. HAYNE, OF SOUTH CAROLINA :

THE RESOLUTION OF MR. FOOT, OF CONNECTICUT,

RELATIVE TO

THE PUBLIC LANDS,

BEING UNDER CONSIDERATION.

DELIVERED IN THE SENATE, JANUARY 26, 1850.

WASHINGTON :

PRINTED BY GALE & SEaton.

1850.

1850.

Here again, as in the broadening of the suffrage and the coming in of the day of pure democracy which had brought General Jackson to the saddle with its dawn, the subtle force of national expansion moved and brooded upon the face of all things. The vast spread and movements of a people, the growth and interlacings of industry, the springing up of States come from the loins of the Union itself, all the visible increase of peaceful empire bred this spirit as of a nation,—no longer merely confederated, a nation knit and united for a common history of achievement. General Jackson, coming from the frontier, where this mighty force of nationality was visibly afoot, seemed to embody the new spirit of power in his rough, imperious sense of a right, as President, to override and command. Mr. Webster, though no friend of Jackson's, clothed what was in effect the same conception in terms of statesmanship and law. Under his touch the constitution seemed to partake of the growth which it had only engendered. It was of necessity, as he read it, no mere document, but a vehicle of life. Its sanctions could be made to cover every change that added to the unity or the greatness of the nation. Its quiet phrases could always be heard to speak the spirit of the times.

But what of those parts of the nation which had kept to the old models of federal life, which did not change, and would accept no law but that which read as it had always read since they were nurtured? The South had had little part or lot in the transformations of the new age. Her life was unaltered from of old. She lived and thought as she had always lived and thought. The Union was still the same to her that it had been to all the States alike in that first generation whose



THE DE WITT CLINTON TRAIN WHICH RAN IN 1830 BETWEEN ALBANY AND SCHENECTADY

Copyright, 1896, by A. P. Yates.

life and thought she kept. There had been no amendment of the fundamental law. Could the law change because men's thoughts had changed and their interests? No doubt, in her reaction against what she saw afoot, she stiffened the old doctrines and exaggerated them. Mr. Madison, who had drafted the Virginia Resolutions of '98, rejected very warmly the nullification doctrines of Mr. Calhoun and Mr. Hayne, not a little stirred and agitated in his quiet retirement at Montpelier by this new threat of disunion. Any doctrine would have worn a look of heightened rigor stated in Mr. Calhoun's clear, uncompromising way, and probably no man of the elder generation, had he been willing to formulate it at all, would have stated it so absolutely. The exigency and the sudden passion of opposition had given it this sharp and novel phrase. Mr. Webster, with characteristic genius, had met it with its opposite, as sharp and uncompromising, the ideal for which the men of the constitutional convention had prayed and which since their day had sprung into life while no man observed.

The times seemed to bring all things to an issue. No doctrine which touched practice so nearly could very long remain a thing of theory while General Jackson was on the field of action, and the advocates of nullification were of no mind to stop with the debate on the western lands. On April 13, 1830, the leading Democrats at Washington celebrated Mr. Jefferson's birthday by a formal banquet, to which the President was bidden. They took their cue from Mr. Calhoun and the southerners, and the toasts they gave smacked shrewdly of nullification. When the President saw their drift he got to his feet and bluntly proposed this

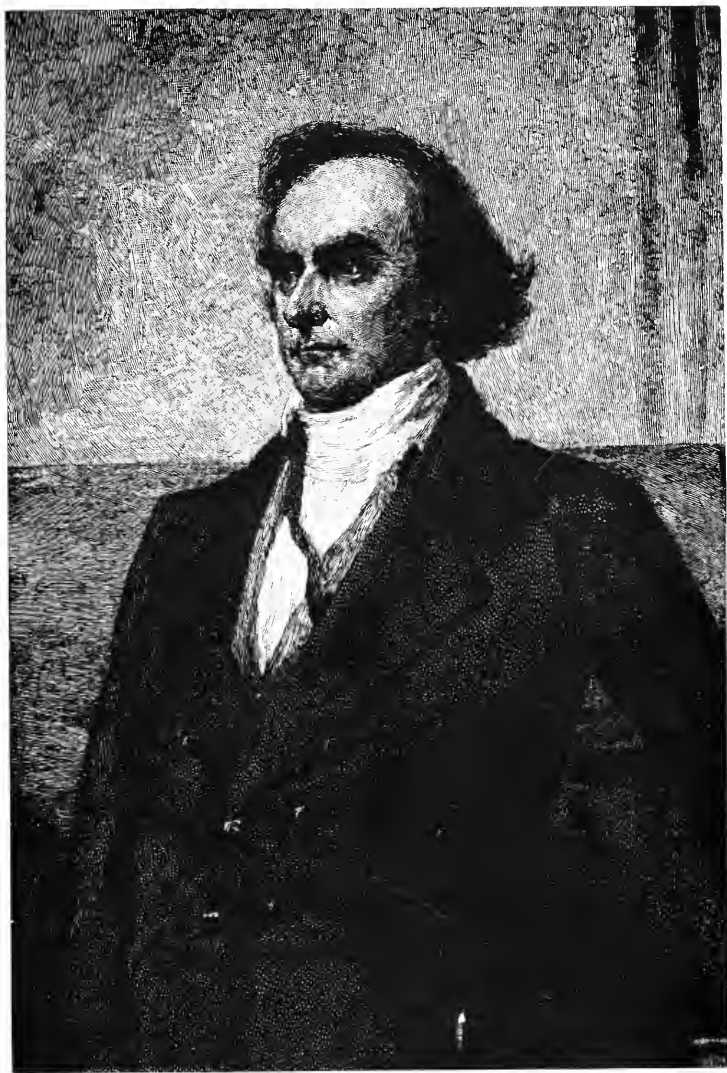

Dan Webster

DANIEL WEBSTER

THE NEW YORK
PUBLIC LIBRARY
ASTOR, LENOX
TILDEN FOUNDATIONS

THE DEMOCRATIC REVOLUTION

sentiment as his own: "Our federal Union: it *must* be preserved." "Liberty, dearer than the Union," cried the Vice President, in retort; but retort only hardened the President's temper; and Mr. Calhoun presently proved the least likely person in the country to be able to soften it. The very month that followed that memorable banquet General Jackson learned for the first time that Mr. Calhoun, who had been Secretary of War

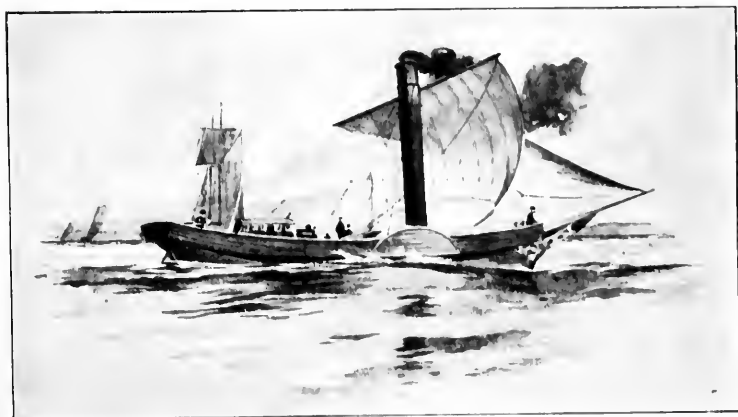

BELL'S STEAMBOAT COMET, 1812

during his campaign against the Seminoles in 1818, had emphatically condemned his unauthorized capture of Pensacola as a wanton act of war against Spain, and had demanded an official investigation of it, with a view to its repudiation. Hitherto he had deemed Mr. Calhoun his friend; now he deemed him basely deceitful for having played his friend after such conduct in cabinet against him. He could not separate official action in such a matter from personal enmity; and no explanation that Mr. Calhoun could make did

more than increase his bitter anger. He turned from all who followed or consorted with the South Carolinian.

Before another year was out he had reconstructed his cabinet, to purge it of Mr. Calhoun's friends, to constitute it of men really in his confidence; partly also to discipline those members of the first cabinet who had failed to satisfy him in a social quarrel. The ladies of the cabinet circle refused recognition to Mrs. Eaton, the wife of the Secretary of War, deeming her reputation not unimpeachable. General Jackson believed her innocent of their charges,—was ready, indeed, to believe any woman innocent, as his own wife had been, against whom cruel things had been said unjustly; and was glad to show his resentment against Mrs. Eaton's enemies by putting the men forth from his counsels whose wives had slighted her against his wishes.

The breach between the President and Mr. Calhoun was a serious sign of the times. It not only embittered the President, it also cut all party ties for Mr. Calhoun, and set him free to work out as he pleased the opposition of his State to the burdensome tariff of 1828. It also made Mr. Calhoun's theories of nullification seem all the blacker, all the more like treason, to the unforgiving old soldier, sure always of being and of having been in the right. It freed Mr. Calhoun and his friends from entangling alliances. They moved the straighter towards their goal,—the vindication of the rights of the "staple States" against the policy of federal tariffs. The hopes of 1828 had been dissipated and the clash of sectional parties was at hand. In 1832 Congress, willing to divert the rising storm by moderate concessions, passed a new tariff Act, substituting for the "abominations" of 1828 a schedule of duties substan-

THE DEMOCRATIC REVOLUTION

tially the same as those of 1824. But the new measure, like the old, yielded nothing of the principle of protection, and the South Carolinian leaders were in a humor now to contest the principle itself and have done with it.

The year 1832 brought the season in which choice was once more to be made of a President, and other matters waited a little until the choice should be certainly known. A novel variety was lent to the field of contest by the entrance of a new party. In 1826 one William Morgan, of northwestern New York, had advertised a book which should make known the secrets of Freemasonry, and had been kidnapped and was never seen again. Popular indignation had fixed upon the society of Freemasons itself as responsible for the crime, and an anti-Masonic party had sprung up whose object it was to keep Freemasons out of places of public trust. It had spread with surprising stir and persistency from State to State, and in September, 1831, it summoned a national convention of its partisans to display its strength and name candidates of its own for the presidency and vice presidency. The regular parties followed its cue. They also chose delegates out of the several States to meet in nominating conventions and put their candidates in the field by formal vote. The National Republicans nominated Mr. Clay, now leader of the Senate and unquestioned leader of the party. The Democrats nominated General Jackson, as of course, for a second term, and with him, for Vice President, not Mr. Calhoun, but his own chosen lieutenant, Mr. Martin Van Buren. The vote of the electors was decisive, as before. But six States voted for Mr. Clay (Massachusetts, Rhode Island, Connecticut, Delaware,

A HISTORY OF THE AMERICAN PEOPLE

Maryland, and Kentucky); seventeen voted for General Jackson. Vermont gave her votes to the candidates of the Anti-Masons. The electors of South Carolina, chosen as always by the legislature, held punctiliously off from all parties and voted for candidates of their own.

The election over, General Jackson once more chosen, her party ties broken, her principles of opposition still unsanctioned and untested, South Carolina proceeded with her radical programme of redress. On the 24th

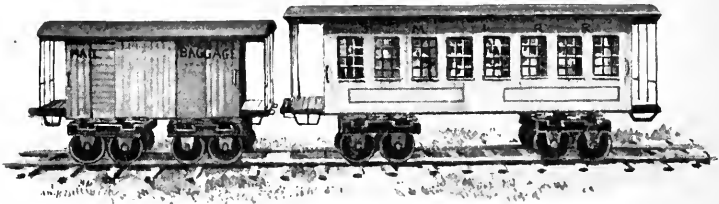

FREIGHT AND PASSENGER CARS, 1848

of November (1832) a state convention, summoned for the purpose and formed upon the model of a constitutional convention, adopted and promulgated a formal Ordinance of Nullification, which declared the tariff Acts of 1828 and 1832 null and void and without force of law within the jurisdiction of South Carolina, and gave solemn warning to the rest of the country that any attempt on the part of the federal government to enforce the nullified laws within her limits would sever South Carolina's connection with the Union and force her to organize a separate government. The legislature of the State immediately took steps looking towards a resumption of some of the powers before for-

mally surrendered to the Union, and provided for putting the State in readiness to resist coercion by force of arms. Mr. Hayne was recalled from Washington to become governor of the State; and Mr. Calhoun resigned the vice presidency to take his place upon the floor of the Senate, that he might there contest every inch of the ground in debate.

The President acted as every one who really knew him knew that he would act. Opposition itself would in any case have been sufficient incitement to action; but now the tonic of the election was in his veins. The natural, straightforward, unhesitating vigor of the man dictated what should be done. "Please give my compliments to my friends in your State," said the imperious old soldier to a member of the House from South Carolina who asked his commands, "and say to them that if a single drop of blood shall be shed there in opposition to the laws of the United States, I will hang the first man I lay my hand on engaged in such treasonable conduct, upon the first tree I can reach." No one doubted that he meant what he said. Before South Carolina's convention met he had instructed the collector of the port of Charleston to collect the duties, resistance or no resistance; and when the Ordinance of Nullification reached him he replied to it with a proclamation whose downright terms no man could misread. For a little space he argued; but only for a little. For the most part he commanded. "The laws of the United States," he said, "must be executed. I have no discretionary power on the subject,—my duty is emphatically pronounced in the constitution. Those who told you that you might peacefully prevent their execution deceived you. . . . Their object is disunion, and dis-

A HISTORY OF THE AMERICAN PEOPLE

union by armed force is treason." It was the doctrine of Webster in the mouth of a soldier. Congress voted the President full power to deal with the crisis as circumstances should demand.

Even then South Carolina did not flinch or draw back; but men who loved peace pressed forward on both sides to effect a compromise. Mr. Clay planned and urged measures of accommodation with all the

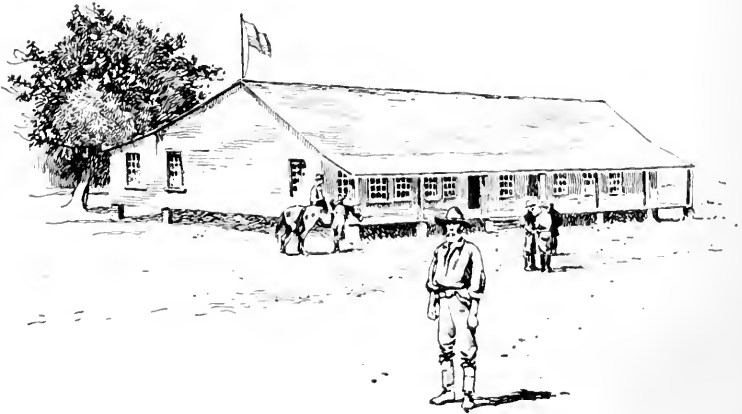

THE FIRST CAPITOL OF TEXAS

skill and ardor and persuasiveness which made him so great a master of men, and the tariff which was a thorn in South Carolina's side, though not in principle abandoned, was radically modified. A schedule of progressive annual reductions was agreed upon (March, 1833) which should by July, 1842, bring practically all duties to the uniform rate of twenty *per cent*. The Ordinance of Nullification was first suspended, then repealed; and the conflict between the States and the Union was for a little while put off.

THE DEMOCRATIC REVOLUTION

The principal general *authorities* for the interesting events covered by this chapter are the second volume of Schouler, the first and second volumes of Von Holst, the fourth volume of Tucker, the fourth volume of Bryant and Gay; A. W. Young's *The American Statesman*; R. McK. Ormsby's *History of the Whig Party*; Edward Stanwood's *History of the Presidency*; Alexander Johnston's *History of American Politics*; James Parton's *Life of Andrew Jackson*; William G. Sumner's *Andrew Jackson in the American Statesmen Series*; Edward M. Shepard's *Martin Van Buren*, in the same series; Carl Schurz's *Henry Clay*, in the same series; Calvin Colton's *Life and Times of Henry Clay*; George Ticknor Curtis's *Life of Daniel Webster* and *Life of James Buchanan*; John T. Morse's *John Quincy Adams* and *Abraham Lincoln* in the *American Statesmen Series*; and Anson D. Morse's *Political Influence of Andrew Jackson* in the first volume of *The Political Science Quarterly*. With these are to be placed, as general authorities for this, that, or the other special phase or aspect of the time and its affairs, Jabez D. Hammond's *History of Political Parties in the State of New York*; Arthur Holmes's *Parties and their Principles*; Byrdsall's *History of the Loco Foco, or Equal Rights, Party*; John McGregor's *Progress of America*; F. W. Tausig's *History of the Tariff*; Henry A. Wise's *Seven Decades of the Union*; Alexander H. Stephens's *Constitutional View of the War Between the States*; the admirable articles on the several topics of American history during these years by Alexander Johnston in Lalor's *Cyclopaedia of Political Science, Political Economy, and United States History*; D. F. Houston's *Critical Study of Nullification in South Carolina* (the third volume of the *Harvard Historical Studies*); Frederick Law Olmsted's *Cotton Kingdom*; the second volume of W. W. Story's *Life of Joseph Story*; Henry C. Lodge's *Daniel Webster*, H. Von Holst's *John C. Calhoun*, Theodore Roosevelt's *Thomas H. Benton*, and A. C. McLaughlin's *Lewis Cass* in the *American Statesmen Series*; James Bryce's *Predictions of Hamilton and De Tocqueville* in the fifth volume of the *Johns Hopkins Studies in Historical and Political Science*; Lucy M. Salmon's *History of the Appointing Power*; and E. C. Mason's *Veto Power* (first volume of the *Harvard Historical Studies*).

The chief *sources* are the *Register of Debates* and *Congressional Documents*; *The Congressional Globe*, which begins with these years; Thomas H. Benton's *Abridgment of the Debates of Congress*; *The Statesman's Manual*, vol. II.; *Niles's Register*, volumes XXXV.-XLIV.; the *Tenth Census, Population*; the first volume

A HISTORY OF THE AMERICAN PEOPLE

of Alexander Johnston's *Representative American Orations*; F. W. Taussig's *State Papers and Speeches on the Tariff*; the *American State Papers*; Josiah Quincy's *Figures of the Past*; George Tucker's *Progress of the United States in Fifty Years*; John Trumbull's *Autobiography*; Amos Kendall's *Autobiography*; Alexis de Tocqueville's *Democracy in America*; S. G. Goodrich's *Recollections of a Lifetime*; Hugh McCulloch's *Men and Measures of Half a Century*; Nathan Sargent's *Public Men and Events*; John Quincy Adams's *Memoirs*; J. A. Hamilton's *Reminiscences; Men and Events at Home and Abroad*; Thomas H. Benton's *Thirty Years' View*; Ben. Perley Poore's *Perley's Reminiscences*; Mrs. Chapman Coleman's *Life of John J. Crittenden*; Basil Hall's *Travels in North America in the Years 1827 and 1828*; John Finch's *Travels in the United States and Canada (1833)*; Mrs. Trollope's *Domestic Manners of the Americans*; Michael Chevalier's *Society, Manners, and Politics in the United States (1834-1835)*; Harriet Martineau's *Society in America (1834-1836)*; Seba Smith's *Letters of Major Jack Downing* (satirical); Martin Van Buren's *Inquiry into the Origin and Growth of Political Parties in the United States*; General Court of Massachusetts, *State Papers on Nullification*; the *Letters, Speeches, and Works* of the leading public men of the day.

CHAPTER II

THE BANK AND THE TREASURY

AGAIN in 1832, as in 1828, it had been a man rather than a party that had won the presidential election. The real issue of the contest had been the re-election or rejection of General Jackson, upon his record as President and political leader. Although he took the result as a verdict against South Carolina, as a verdict against every one who withstood his authority either as man or as President, the nullification issue had not been made a test of doctrine or policy by either party. It was passed by, as if politicians wished to ignore it. So far as it was a contest concerning policy at all, and not a mere attack of the conservative forces of the country upon General Jackson himself as a radical and the author or spokesman of all revolutionary error, the contest centred upon the question of the Bank. It was the President's hostility to the United States Bank that was the Opposition's chief item of indictment against him. They attacked him also, it is true, for his unfriendly attitude towards the protective system and for his unwillingness to allow liberal outlays to be made for internal improvements. But he had in fact been more tractable than they had expected in those matters. He had really suffered Congress to go its own way in adjusting the tariff, and had yielded now and again to its ardor for spend-

ing money out of the federal treasury for the improvement of harbors and for the prosecution of other public works which promised to result in a general benefit to commerce. Only on the question of the Bank had he stood stubborn and forced the fighting.

The charter of the Bank was not to run out until 1836. It had not been necessary or wise to force the

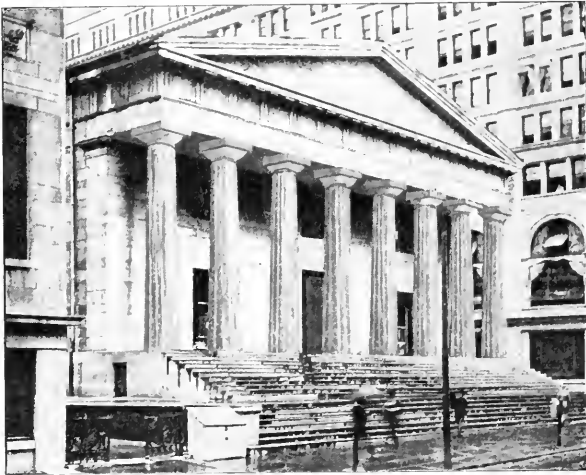

THE OLD UNITED STATES BANK, NOW THE CUSTOM HOUSE,
PHILADELPHIA

question of its renewal to an issue in 1832, to be confused with the question of General Jackson's popularity and personal prestige. The conservatives in Congress had been betrayed into a grave tactical blunder, because they shut their eyes to the real signs of the times. They did not yet know the rules of prudence in a day of personal politics; did not understand the subtle elements of the play; did not know the opinion of the country or comprehend the drift of affairs.

THE BANK AND THE TREASURY

The Bank of the United States had been first created in 1791, and the question of the right of Congress to establish it had been duly fought out then, as it were at the very founding of the government. Both Congress and the Executive had accepted the conclusions of Mr. Hamilton in the matter, and rejected the conclusions of Mr. Jefferson. Mr. Jefferson's party had allowed the charter of the Bank to lapse in 1811, when their day of power came, professing themselves opposed to it on principle; but in 1816, finding the exigencies of finance powerful solvents of their scruples, they had changed their minds and had given it another twenty-year charter. Three years later the Supreme Court of the United States (*McCulloch vs. Maryland*, 1819) confirmed the reasoning of Mr. Hamilton with regard to its constitutionality in a formal decision, and set the views of every scholarly lawyer in the country once for all at rest on the matter.

But General Jackson had come in "to simplify and purify the workings of the government, and to carry it back to the times of Mr. Jefferson,—to promote its economy and efficiency, and to maintain the rights of the people and of the States in its administration"; and from the outset, with something of the instinct of the communities in which he had been bred, he looked upon the Bank as an enemy of constitutional and democratic government. His attack upon it, begun in his first inaugural address, had been continued in every annual message he sent to Congress. He had begun by plainly intimating a doubt as to the legality of its institution, the Supreme Court to the contrary notwithstanding; and had asserted that it had failed to establish a stable currency. He next pronounced it an "un-American monopoly." Finally he expressed serious misgivings

as to the soundness of its management. At each mention of it his warmth sensibly increased; his hostility became more open and aggressive. The purpose apparently grew upon him to destroy it. He forced it to meet him, as challenger, and fight for its life in the open field of politics. Influences were at work upon him which were only by degrees disclosed to his opponents.

The constitution of the Bank unquestionably placed it very near the government itself. Its capital stock was \$35,000,000, and of this the federal treasury held nearly one-third by direct subscription (\$11,000,000); five of its twenty-five directors were appointed by the President of the United States; it was the depository of the public funds and enjoyed the use of them without interest; it was empowered to issue circulating notes to the full par value of its capital stock; and its notes were made receivable by the United States as cash for all debts. Congress pledged itself to create no other bank while the charter stood. In return, the Bank had paid the federal government a million and a half dollars for its franchise, and undertook to negotiate the loans of the government without charge or commission. Its notes it was obliged by law to redeem in specie on demand. Although a private corporation and carefully planned upon conservative and prudent principles, it was unquestionably the ruling force in the money market, and took its power from its connection with the government. Undoubtedly, too, it had been intended to play this dominating part and was by design a political institution. It had been Mr. Hamilton's object, in setting up the first Bank of the United States, to bring the money transactions of the country under a

THE BANK AND THE TREASURY

central control, to check the experimental banking operations of the States, and to draw the capitalists of the country and the greater organizers of industry to the active support of the federal government upon grounds



Alexander Stephens

ALEXANDER H. STEPHENS

of interest. The second Bank, now under fire from the Executive, had been given the same constitution and function.

The supporters of the Bank were in a measure justified in claiming that it was for such a purpose that the very government itself had been set up. Nothing had

more obviously threatened quick and overwhelming disaster to the country in the days of the Revolution and the Confederation than the reckless financial operations of the States, their unlimited issues of irredeemable paper, their piled up promises and meagre means of redeeming them; and the constitution of the Union had been framed almost as much to avert ruin from that quarter as to create a real government, clear up the relationships of the States to one another, and steady their political action. It absolutely forbade the States to issue bills of credit, did not give the federal government itself power to do so, and was meant practically to prohibit the use of any currency which was not at least based directly upon gold and silver. But the courts had opened new flood-gates. They had ruled that, although the States themselves could not legally issue bills of credit, they could incorporate private banks authorized to issue notes at pleasure, with or without proper security for their redemption,—could even themselves invest public moneys in the stock of such banks and become virtual partners in the irresponsible business. Gold and silver were hard to get, came within reach of eager borrowers only in the most niggardly quantities, and could be had only for securities in hand. The adventures of growth and industry in a new country where everything was making and to be made demanded easy credit, to be had for the asking, and abundant money; and had only promises and hopes to offer for security. Banks of issue sprang up everywhere that there was expectation and sanguine confidence; and every possible vagary attended their operations. No man could tell a day's journey from the bank whose paper he carried whether it would be accepted and serve him as money or not.

Only a great commanding bank, everywhere known, whose notes really and always represented gold could supply paper worth its face value in all places or keep exchanges from chaos.

Such an agency of adjustment and control the Bank of the United States had proved itself to be. It had not only served its purpose as a fiscal agent of the government to the satisfaction of the Treasury, but had also steadied and facilitated every legitimate business transaction and rid the money market of its worst dangers. But many of the men to whom General Jackson was accustomed to listen believed, or affected to believe, that it had done much more: that its power was used to serve a party and to keep men who were no friends of the people or of popular rights in a position to manage and corrupt the whole politics of the nation. They reasoned out of experience. The state banks were everywhere notoriously tainted with political partisanship, — were almost everywhere familiar, recognized engines of party supremacy. No one who was not of the political majority in the State could get a banking charter from a state legislature; no one was absolutely sure of credit or indulgence at a state bank except those who were of the party of its directors. It had come to be looked upon as a matter of course that banks should be used as parts of the machinery of political control. General Jackson and his partisans could not believe that the great Bank of the United States was free from a similar taint. It had certainly been established by men of the party which they were now trying in all things to supplant, the men who had turned away from General Jackson and followed Mr. Clay. It was part of the old, suspected, aristocratic order which the new democ-

racy had come in to set aside, and everything that it did was subjected to suspicion.

The Bank had branches throughout the country, at points of convenience where business centred. Friends of General Jackson complained that men openly opposed to them in every party interest were appointed officers of these branches, even in States which had cast their votes for General Jackson and the new régime; that loans were refused and collections insisted on in a way which was offensive to the partisans of the Administration; and that money was used in the elections against them. They were particularly indignant that Mr. Jeremiah Mason, an incorrigible Federalist, had been made president of the branch bank at Portsmouth, in New Hampshire, and had shown himself disinclined, as they had expected, to afford friends of General Jackson any unusual indulgence or accommodation in matters of business. Concrete cases fixed General Jackson's convictions in such matters as no argument upon the merits could fix them. Here was a very tangible example of what he had been led to suspect. The story came straight from friends whom he trusted,—from Mr. Levi Woodbury and Mr. Isaac Hill, the two men who had been chiefly instrumental, he had reason to believe, in winning New Hampshire over from the Federalist to the Jackson interest. Mr. Hill was editor of the *New Hampshire Patriot*, and had an editor's inside view of the politics he had had so large a share in shaping. He was also one of the officers of a bank at Concord which was operated under a charter from the State, and had a state banker's knowledge of what the branches of the Bank of the United States could do to dominate credit and control exchanges. Mr. Wood-

bury had been chosen a senator of the United States in 1825, and had from the first been received into the intimate counsels of the new President. Mr. Hill had left his bank and his paper in New Hampshire to put himself at the service of the Administration in Washington, and had become, as everybody knew, a member of the "Kitchen Cabinet." When such men told him of the influence of the Bank in New Hampshire, the President could but believe them. Mr. Kendall brought him the same report of its influence in Kentucky. It had undoubtedly, he said, spent money there to secure the success of Mr. Clay and the defeat of General Jackson.

It seemed a significant thing that Jeremiah Mason should have been chosen for president of the branch bank at Portsmouth. He was unquestionably the political opponent whom the Jackson leaders in New Hampshire most feared, and had most reason to fear. His character gave him a very noble eminence; his extraordinary abilities as a debater and his exact knowledge as a lawyer gave him an instant hold upon every thoughtful audience. All the country knew how formidable Mr. Webster was in debate, and Mr. Webster ascribed no small part of his own power to the lessons he had learned when pitted against Mr. Mason at the bar.

The President had no mind to let the case go unnoticed. Mr. Ingham, the Secretary of the Treasury, brought it to the attention of Mr. Biddle, the President of the Bank of the United States (1829), in a letter in which he frankly took it for granted that Mr. Mason had been appointed because of his hostility to General Jackson; plainly intimated that the whole object of the Bank's establishment and management had been

A HISTORY OF THE AMERICAN PEOPLE

to strengthen "the arm of wealth" in order to "counterpoise the influence of extended suffrage in the disposition of public affairs"; and urged that the Bank clear itself



N. Biddle

NICHOLAS BIDDLE

of the suspicion by drawing its officers and appointees from both political parties without discrimination. Mr. Biddle replied with natural indignation. It was easy to refute the charges made. In the particular case of

THE BANK AND THE TREASURY

the branch bank at Portsmouth the well known character of Mr. Mason made them ridiculous. It could be shown conclusively enough that, whatever party the officers of the Bank happened to be chosen from, its affairs were conducted in accordance with sound principles of business, and with no view to either giving or withholding favors upon political grounds. Mr. Biddle found no difficulty in framing a reply which should have convinced all candid men upon the main points at issue.

He made a grave tactical blunder, none the less, in the tone and method of his defence. He knew the temper and susceptibilities of the men he was dealing with and the temper of opinion in the country as little as Mr. Clay did and the men who stood with Mr. Clay against the President in Congress. The warmth of Mr. Biddle's reply to the Secretary, however natural, was most impolitic; and he did not content himself with refutation, but went on to utter what seemed little less than a defiance. He reminded Mr. Ingham that the Bank of the United States, whatever its business connections with the federal government, was a private corporation, accountable to no one but its own directors for the conduct of its affairs. Mr. Ingham responded with a pointed threat. He reminded Mr. Biddle, in his turn, that the law by which the Bank was incorporated authorized the Secretary of the Treasury to withdraw the deposits of the United States when he deemed good cause for the withdrawal to exist.

Mr. Ingham retired from the Treasury upon the reconstruction of the cabinet which followed the President's breach with Mr. Calhoun, and Mr. Louis McLane, of Delaware, took his place (August 8, 1831), a man of

better balance and more liberal spirit, trained in the older school of politics. In December, 1831, his report to Congress ran strongly and unmistakably in the Bank's favor, and it began to look as if the temper of the Administration had already cooled and altered in the needless quarrel, which was of its own making. But the friends of the Bank were not wise enough to let the matter drop. Its charter was safe at least until 1836, and General Jackson, they might have hoped, would learn the Bank's value by experience, should he remain President until then. But Mr. Clay advised that application be made at once for a renewal of the charter, while the houses certainly held a majority favorable to it; and the advice was imprudently taken. The matter was pressed at once, and in the summer of 1832 (June-July), during the session which immediately preceded the presidential election, a bill renewing the charter passed the Senate by a vote of 28 to 20, and the House by a vote of 109 to 76. It was a direct challenge, and General Jackson of course met it with a veto, delivered point-blank and without hesitation. The Bank's majorities in the houses were not large enough to pass the bill over the veto; and Clay men and Jackson men alike turned to the country for its verdict.

The folly of staking the fortunes of the Bank against the popularity of General Jackson at the polls was quickly enough demonstrated. It was much easier for the mass of men who now held the votes of the country to believe the Bank a dangerous and corrupt monopoly than to understand the arguments of statesmen who argued of its services to the government and to commerce. They recognized General Jackson as a man of their own instincts, and deemed those instincts

a sure enough guide in politics. Statesmen might approve of the Bank, but the people thought of it only to suspect it, and preferred General Jackson to all the statesmen the Bank could muster to its standards. A second time they chose General Jackson President. He interpreted their votes to mean a deliberate verdict against the Bank,—a command to destroy it; and its fate was sealed. The President proceeded with characteristic promptness and directness. He first turned to Congress (December, 1832), the very Congress which had passed the vetoed bill, and asked for an investigation, to ascertain whether it was still safe to leave the deposits of the government with the Bank, in view of its mismanagement and probable insolvency. No one but General Jackson and a handful of politicians about him seriously questioned the good management of the Bank or for a moment doubted its solvency, even then, with its charter evidently doomed; and the House very emphatically declared that in its opinion the deposits were safe. General Jackson, accordingly, determined to act without Congress and on his own responsibility. He resolved that the Bank should no longer be given the custody of the public funds.

The statute under which the Bank was incorporated conferred the power to act in that matter, not upon the President, but upon the Secretary of the Treasury. The President therefore wrought his will upon the Treasury Department. Mr. McLane, whom he knew to be favorable to the Bank, he transferred from the secretaryship of the Treasury to the secretaryship of State, appointing Mr. Edward Livingston, then Secretary of State, minister to France, and putting Mr. William J. Duane, of Pennsylvania, who was known to be an

opponent of the Bank, in charge of the Treasury Department. Mr. Duane showed unexpected scruples, and declined, out of a mere sense of duty, to make way for the execution of the President's radical plan. He was dismissed, therefore, within four months of his appointment, and the Treasury was put into the hands of Mr. Roger B. Taney, of Maryland, the Attorney General, whose views the President knew to be his own (September 23, 1833). An order from Mr. Taney forthwith directed (September 26) that the revenues thereafter accruing should be deposited, not with the Bank of the United States, but with certain state banks selected by the Secretary for the purpose, and that the balance of the government in the Bank of the United States, then nearly ten millions, should be drawn upon for the government's expenses until exhausted. The thing was done at infinite hazard of financial panic. The Bank was obliged to curtail its loans very sharply and at once, in order to bear the drain, which was to be offset by no replenishment; there was immediate distress in the money market, a sudden flutter of credit; and only the sound condition of business at the moment prevented crisis and disaster.

The President spoke of the matter in his annual message with his usual intrepid frankness: took the whole responsibility for what had been done upon himself, and justified it. No one whose opinion was of any weight in such a matter had approved of the removal of the deposits; his own cabinet had been opposed to it, as both unwise and of doubtful legality, and had united with Mr. Duane in trying to turn him from his purpose; but he had gone his way without pause, hesitation, or excitement, like a man convinced and confident.

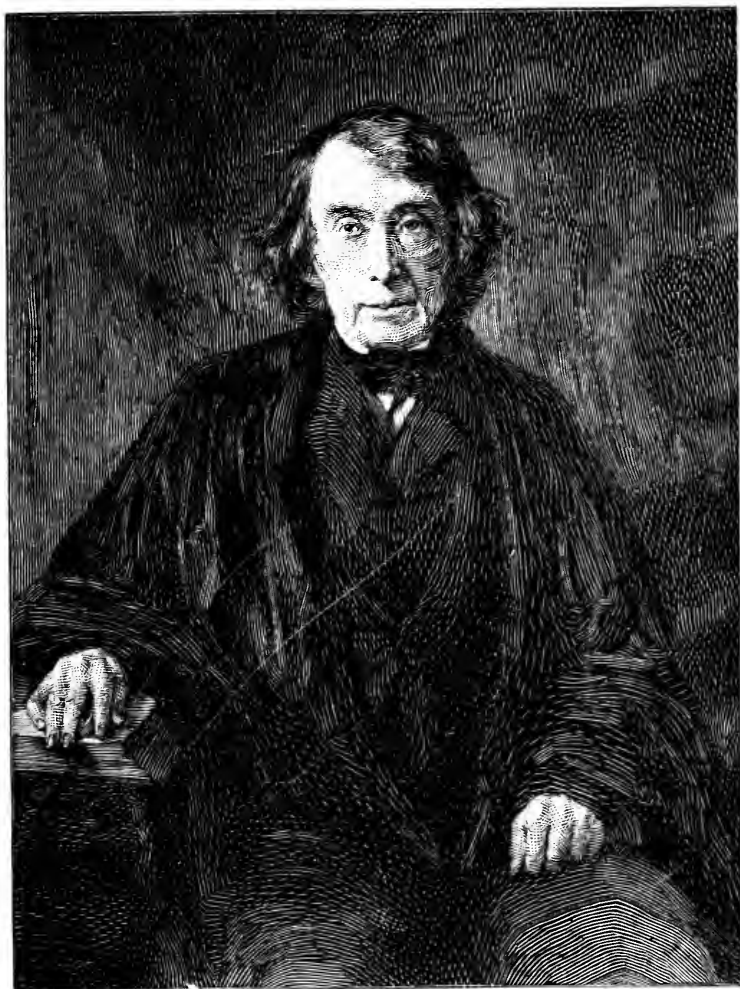

R. B. Taney

ROGER B. TANEY

He believed that the Bank had gone into politics to prevent his re-election, in 1832 if never before. Its directors admitted that large sums had been spent out of its funds for pamphlets, for speeches, for every legitimate means of agitation in the campaign, which it knew to be a struggle for its life; and the President, who, with Mr. Clay as ally for the nonce, had forced it thus to meet him in the field of party action, now declared that the issue had come to this, "whether the people of the United States were to govern through representatives chosen by their unbiassed suffrages, or whether the power and money of a great corporation were to be secretly exerted to influence their judgment and control their decisions." He made no scruple of the law in the case, deeming law meant for the service of the country.

The new House of Representatives, elected in the autumn of 1832, was now controlled by his friends, and supported him. The Senate, on the contrary, still stood against him, led, as before, by Mr. Clay, Mr. Webster, and Mr. Calhoun; and spread upon its minutes a public and formal censure, in which it earnestly condemned both the dismissal of Mr. Duane and the removal of the deposits. General Jackson replied in an equally formal protest, which ran hot and imperious. It spoke his whole theory of constitutional obligation: his resolution to be bound by neither court nor senate, nor any precedent whatever, but only by his own conviction of duty as a representative of the people under the constitution. The contest was ended. The Bank of the United States quietly made ready for the expiration of its charter, and when it came (1836) accepted in its stead a charter from the State of Pennsylvania.

THE BANK AND THE TREASURY

But the effect of what the President had done had by no means passed or spent itself. General Jackson had said that the Bank of the United States did not give the country a stable currency. The country had an



Louis McLane.

LOUIS McLANE

opportunity to see for itself what service it had rendered when its check was withdrawn. It was no sooner discredited than the old inflation of bank issues came again, with wider range and play of destructive force than ever. The "pet banks," as they were promptly dubbed,

to which the deposits of the government had been transferred, were selected upon party principles,—were one and all “Democratic” banks in the South and West, whose directors were of the President’s party. Their number was fixed by no law or principle, and began from the outset to be added to from time to time, as this, that, or the other influence of interest or persuasion obtained the patronage of the government for banks not at first favored with a place on the list. State banks saw their day come again. State legislatures multiplied banking charters without safeguard or limit. Every bank sought the government’s favors; but none was discouraged because it did not obtain them. All banks were banks of issue. Those that did not have the government’s money to lend loaned their own abundant notes. Paper money seemed to pour of a sudden from every town and hamlet, and speculation began to heap risk upon risk to make use of it. The real money centres of the country had little part or lot in the business. Enterprise ran freest where chiefly compounded of hope,—where the resources of the country, though unmistakably rich with every promise of abundant profit, were as yet undeveloped, awaiting the slow processes of industry. The bubble of credit glistened resplendent with all the hues of the round globe, until General Jackson himself, in his rough honesty, pricked it.

The first strain and flurry came by reason of the mere superabundance of the national revenues. Business had been sound and prosperous until this new policy which upset the Bank came to disturb it, and the government had shared the profits of the merchant and the manufacturer. By the close of the year 1835 it was entirely free from debt. The revenues which filled its

coffers could not be reduced: they came chiefly from the tariff duties as fixed by the compromise Act of 1833, and that was a pledge of peace between parties which no man cared to alter. Rather than keep surplus piling upon surplus, accordingly, Congress ordered (June, 1836) that on and after the first of the following January all surplus funds over and above five millions should be distributed, quarter by quarter, among the several States, as loans without interest which Congress might at its pleasure recall. Not a few of the pet banks found themselves considerably embarrassed to meet the drafts upon them by which the quarterly distributions were made; but the States found speculative schemes to put the money into quite as readily as individuals did; the movement of business was not disturbed; and before the year was out there were no more such disbursements to be feared. Only three quarterly payments were made,—a total of twenty-eight million dollars. After that there was no surplus to distribute. General Jackson had pricked the bubble.

The President had a very sturdy and imperative sense of right and honesty in all money matters. He believed gold and silver to be "the true constitutional currency" of the country, he said. He demanded of the pet banks that they should keep specie enough to cover at least a third of their circulation, and that they should issue no notes of a lower value than twenty dollars. He increased the output of the mints and tried by every means to force coin into circulation. He had no idea of letting the country try again the fatal experiment of an irredeemable paper currency, if he could prevent it; and when he saw the fever rising in spite of him he tried a remedy as drastic and wilful as

his destruction of the Bank of the United States. Speculation and hopeful enterprise had had an extraordinary effect upon the sale of the public lands. In 1834 the government had received less than five millions from that source. In 1835 the sum sprang up to more than

PRESIDENTIAL RACE—TICKET. Three pica one.



Go it, ye Cripples!
Democratic Ticket.
 FOR PRESIDENT, !
Martin Van Buren.
 FOR VICE PRESIDENT,
RICHARD M. JOHNSON.
 OHIO ELECTORS.
 JOHN M. GOODENOW,
 OTHNIEL LOOKER,
 JACOB FELTER,
 JAMES B. CAMERON,
 DAVID S. DAVIS,
 JAMES FIFE,

ELECTORAL TICKET OF 1836

fourteen millions, and in 1836 to nearly twenty-five millions; and the money poured in, not, of course, in gold and silver, but in the depreciated currency of innumerable unknown banks. The Treasury was forbidden by statute to receive any notes but those of specie paying banks; but things had by that time already come to such a pass that no man could certainly or safely distinguish the banks which really kept a specie reserve from those which only pretended to do so. On July 11, 1836, accordingly, by the President's command, a circular issued from the Treasury directing the land agents of the government to accept nothing but gold or silver in payment for public lands. Again, as in the case of the Bank, the President's advisers drew back and dis-

approved; but again he assumed the full authority and responsibility of his sovereign office, and delivered his blow without hesitation or misgiving.

The effect was to shatter the whole fabric of credit. But the consequences did not disclose themselves at once. General Jackson had retired from public life and Mr. Van Buren had succeeded him in the presidency (March, 1837) before the inevitable day of disaster and collapse had visibly come. The imperious old man must have looked back with not a little satisfaction upon the long series of personal triumphs he had won, against trained statesmen and old parties intrenched against him. Even in diplomacy his energy and prompt initiative had won him successes denied to his predecessors. He had sent Mr. McLane to England to say that all our restrictions upon the carrying trade of England would be repealed if England would remove those which she had put upon the carrying trade of the United States in the West Indies; and the ports which had been shut in the faces of Mr. Gallatin and Mr. Adams were opened to him, Congress promptly fulfilling his promise with regard to the action of the United States (May 29, 1830). He pressed upon the new government of Louis Philippe in France, and upon the other governments as well which had been at fault in the matter, the claims of the United States for depredations unlawfully committed upon American commerce during the Napoleonic wars; and the claims were recognized and paid. He moved straight and openly upon every object he desired, and his very directness seemed to add dignity and scope to the government over which he presided. He had created a party and put subtle revolution into affairs by sheer force of individual qual-

ity, and left his great place and office before either he or the men who loved and followed him were aware what mischief he had unwittingly done, — how the whole framework of settled politics had been shaken and loosened at every joint by his wilful supremacy.

General Jackson had obliged his followers to accept Mr. Van Buren as his successor in the presidency: they were dominated by his will in this as in all things. The convention which nominated Mr. Van Buren had met a full year and a half before the election (May, 1835), while the power of the indomitable President was at its mid-term vigor; had been irregularly made up, its ranks crowded with men who held office under the President; and signs of faction and revolt had not been wanting. The country had chosen lukewarmly, too, the man whom the party had named perfunctorily. His majority in the electoral college had been but 47, as against General Jackson's majority of 152 four years before; his popular majority only 26,000, as against General Jackson's 157,000. The opposition had lacked unity and organization; hardly constituted a party at all; consisted, rather, of various groups of several shades of opinion; and put several candidates into the field: General William Henry Harrison, of Ohio, Mr. Webster, and Judge Hugh L. White, of Tennessee, for whom Tennessee voted, General Jackson notwithstanding. But, rank and file, the Democrats had stood by Mr. Van Buren. In him they acknowledged their debt and allegiance to General Jackson.

Not a little strength of character underlay Mr. Van Buren's bland exterior, his conciliating manners, his air of sweet accommodation. He was also, in his way, a consummate master of men. He mastered them by

THE BANK AND THE TREASURY

insight, by intimate and friendly counsel, and by knowing the end he sought. But he did not rule or dominate by force of will. That slender little gentleman, always courteous, always placid, always ready to listen, and wait to have his way, could not hold or rule the imagination as the rugged veteran did who had preceded

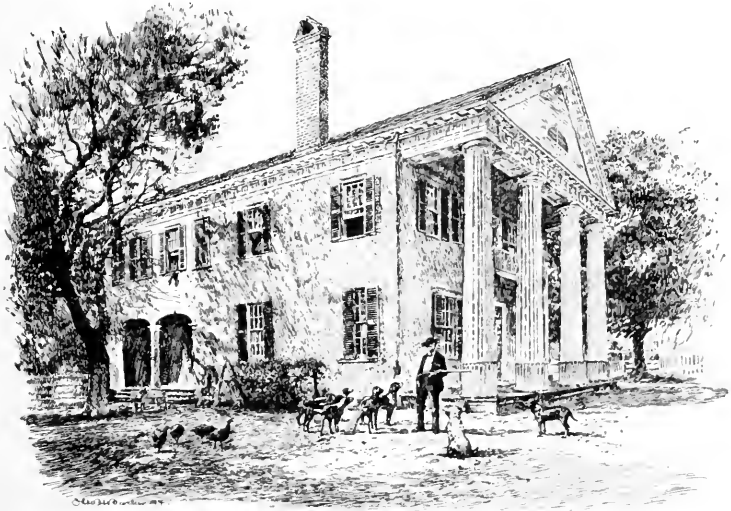

A NORTH CAROLINA MANSION OF THE OLD STYLE

him, tall, gaunt, sad-faced, majestic, carrying fire, gracious and grim by turns. The country regarded its new, soft-spoken President much as an audience would regard a bland, mellow-voiced, facile player brought on as understudy to some intense tragedian; was slow to take him seriously, slow to be convinced that he had an individuality and a power of his own. He seemed tacitly to promise in everything that he said that at every point of policy his administration should

be but a continuation of what his predecessor had begun; and men looked on with curiosity rather than with sympathy, were more ready to criticise than to applaud.

While Jackson reigned he had seemed rather the maker than the representative of policy, and the Democratic party had been with difficulty discernible behind his stalwart figure, standing always at the front of the stage. Now at last it entered the play, as itself an independent and originative force in affairs, the President merely one of its leaders. The revolution wrought in political action by the coming in of General Jackson had fairly shaken parties asunder. Throughout his administration they had sought rather than obtained a new order and cohesion. The "National Republicans," who had stood with Mr. Adams and Mr. Clay, had been even when at their strongest something less than a national party. Adherents had come and gone while the fighting thickened about General Jackson in Senate and House. When Mr. Van Buren became President they were still, if separately distinguishable at all, only the chief group among many groups combined in opposition. The Democrats were at last a veritable party; Mr. Clay's friends were only part of a party. Not until 1834 did the grouped Opposition of which they formed the centre acquire a party name, or begin to arrange the definite concerts of party action. By the summer of 1834 they were coming to be spoken of very generally as "Whigs." National Republicans; Anti-Masons; men who thought that South Carolina had been too harshly dealt with, to the detriment of constitutional state rights; men who condemned Jackson's high-handed way in the matter of the deposits, "the immolation of Duane and

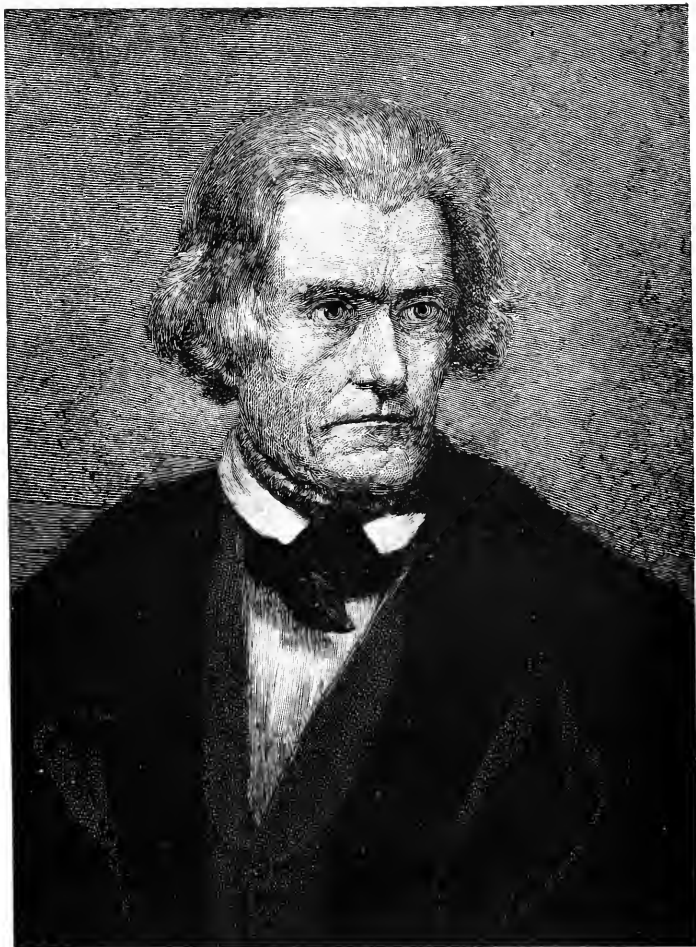

J. C. Calhoun

JOHN CALDWELL CALHOON

THE NEW YORK
PUBLIC LIBRARY
ASTOR, LENOX
TILDEN FOUNDATIONS

the subserviency of Taney"; all who were startled to see how of a sudden a President had made himself as it were the master of the government, drew slowly together, and a great party was created. Insensibly, when power came to it, and the heartening breath of success, it reproduced the principles and spirit of the Federalists: their liberal way of interpreting the constitutional powers of the government, their confident enterprise in pushing forward to new programmes of action and putting the government at the front of the nation at every step of its progress, their belief in constructive statesmanship and the efficacy of legislation in the development and determination of the country's life. But for the present it was merely a party of opposition, set over against the Democrats, who were in charge of the government and yet did nothing: did nothing, apparently, upon principle. General Jackson had in fact carried the government back to the principles of Mr. Jefferson, as his friends had said that he would: had squared its action with those principles more perfectly a great deal than Mr. Jefferson himself had done. His intense and aggressive activity in affairs had obscured the fact while his personal power lasted; but he had spent his telling energy upon clearing the field of what his predecessors had constructed,—not upon making but upon setting aside; and he left a party behind him which had imbibed his spirit: which desired no new era of Federalistic policy; which wished to see the field kept clear of unnecessary laws and fostered institutions, of great corporations created for the use of the government and favored enterprises subsidized in the interest of a class; which desired to see authority used, not to patronize or foster, but only to give the

government the necessary force and to administer it with a wise and honest moderation, while all things went their natural course, unpetted and unhampered.

It faced a crisis with principles negative and opposed to action, and yet faced it undaunted, advocating only a safe withdrawal of the government from the field of danger. Within two months after Mr. Van Buren's inauguration General Jackson's "specie circular" had done its work. A sharp financial crisis racked the business of the country from end to end, and brought with it a panic stubborn and hopeless, which seemed for months together as if it had come to stay. It had been strain enough that the money market had had to accommodate itself to the preparations of the Bank of the United States for the winding up of its business, and to the distribution of the surplus among the States. There had been a rapid increase, besides, in the volume of imports since 1832, and considerable sums of specie had had to be sent out of the country to meet the balances of international trade. The specie circular had come with cruel opportuneness. Bankers and borrowers alike had been reckless; credit was already out of breath. When the great sums of paper that had gone west for the purchase of lands from the government came suddenly back by the hundreds of thousands for redemption there was instant collapse and panic. Most of the banks had no specie and were utterly unprepared to redeem their notes; those that had specie could afford no relief,—had themselves too little to take care of their own notes. There was a universal suspension of specie payments, and credit was dead at a stroke. There had been signs enough of what was about to happen before the end came. A feverish rise in prices had

THE BANK AND THE TREASURY

preceded it. The price of flour, which had been but five dollars in 1834, had shot up to eleven dollars per barrel during those first uneasy months of 1837; the



Silas Wright Jr

SILAS WRIGHT, JR.

price of corn had risen from fifty-three cents per bushel to a dollar and fifteen cents; and in February and March there had been bread riots in New York.

On May 15th the President issued a call for an extra session of Congress, to be convened on the first

Monday of September. He had, it turned out, nothing to propose except that the interests of the government should be looked to. The pet banks had gone down with the rest, and it was necessary that the government should secure its revenues. Mr. Van Buren had no thought of receding from the policy of the specie circular; on the contrary, he had himself, amidst the very signs of acute and increasing distress, issued a similar order with regard to the transactions of the Post Office. He stood stubbornly for specie payments, banks or no banks, and had aggressive spokesmen at his back in Congress: notably Mr. Wright and Mr. Benton in the Senate. Mr. Silas Wright, of New York, was the President's close friend, in politics and out of it; had been bred in the same school of politicians; had the same astuteness in policy, and was yet, like Mr. Van Buren himself, steadfast in the maintenance of such principles as he saw and believed in. He was of the school of those who fought for party success and studied the subtle art of party management. He was no student of principles—a politician of the new day, rather; but honest and ready to act upon conviction. He believed, as all Democrats of the new cast did, that the offices of the government belonged to the majority, as “the spoils of victory”; but he avowed the belief with no touch of cynicism,—with the naturalness, rather, and unaffected candor with which a man avows principles he sees no need to be ashamed of; and he could, with equal naturalness and honesty, now bring forth out of his singular assortment of motives, as politician and yet as statesman too, a stern faith in the honesty and necessity of “hard money.” Mr. Benton was no partisan of the administration: he was too

THE BANK AND THE TREASURY

intense an egotist to be any President's personal adherent or spokesman. But he, almost alone amongst public men of experience, had encouraged General



Sam Houston

SAM HOUSTON

Jackson to put forth the specie order; and he was now ready to give the administration his hearty support in the maintenance, so far as the government was concerned, of specie payments.

The President and his spokesmen had nothing to

propose for the relief of business. He believed, as Mr. Calhoun did, that palliatives would only prolong the unavoidable misery of readjustment and the return to sound methods of business, the substitution of real for fictitious values and of production for speculation, and that, bad as they were, things would right themselves more quickly and more wholesomely without the intervention of legislation than by means of it. His plan was, to cut once for all the connection of the government with the banks, and provide for the custody, handling, and disbursement of the revenues by the Treasury alone. For three years, through two Congresses, he fought doggedly for his purpose; and won at last in midsummer, 1840. Then he got exactly what he wanted. An "Independent Treasury Act," signed July 4, 1840, provided that the Treasury of the United States should itself supply vaults and places of deposit for the revenues, at Washington and at other cities appointed for their receipt; that all federal officers charged with their receipt, safe keeping, or disbursement should be put under proper and sufficient bonds for their careful and honest use and custody; and that all payments thereafter made either to or by the United States should be made in gold or silver only. It had not been possible to bring the first Congress of Mr. Van Buren's term to accept this scheme. Twice adopted by the Senate, now at last Democratic, it had been twice rejected by the House, where a section of the Democratic majority united with the Whigs to defeat it. Meanwhile the President had been obliged to do without law what he wished Congress to authorize by law. The banks of deposit had suspended payment; there was nothing to be done but to direct the agents of the Treas-

THE BANK AND THE TREASURY

ury to keep and account for as best they could the moneys which came into their hands.

Meanwhile, too, the country went staggering and



C.H. McCormick

CYRUS HALL MCCORMICK

bewildered through its season of bitter ruin. There had been nothing like it before in all the history of business in America. Utter collapse and despair came, soon or late, upon every sort of undertaking the year

through. Radically unsound banking laws in the States had been at the bottom of all that had happened to bring disaster on; and yet no one could reasonably wonder at the hopes and schemes which had bred that swift and fatal fever of speculation. Abounding wealth unquestionably awaited the enterprise and industry which should develop the rich valleys of the West, plant productive communities there, and unite East and West by road and river; and means of quick development had at last been found which promised fulfilment of every dream within a single life-time,—it might be within a single decade,—who could tell? It seemed as if, in this very decade of Jackson's reign and the new democracy, the world had hit upon ways of almost instant increase of wealth and power, where resources were at hand, virgin and inexhaustible. It was then that railways began to be built and steam boats put upon the rivers; and the great spaces of the continent began to seem no longer insuperable obstacles to the growth men had dreamed of and strained after ever since the landing at Jamestown. Robert Fulton had put a successful steam boat on the Hudson as long ago as 1807; but until now steam craft had seemed hardly more than novel conveniences, to be experimented with. Now at last they began to be built in numbers sufficient to quicken and facilitate enterprise and settlement. Railways seemed to spring suddenly into existence, to serve the same end. In 1830 there were but twenty-three miles of rail in the country: a short road here and there for cars drawn by horses. But presently steam was brought into use for the propulsion of cars also; and within five years (1835) no less than thirty million dollars had been invested in railroads. Before the

THE BANK AND THE TREASURY

crisis of 1837 came more than fourteen hundred miles of railways had been constructed; and by the time Mr.



John G. Whittier

JOHN GREENLEAF WHITTIER

Van Buren went out of office (1841) there were more than three thousand, the crisis notwithstanding.

Invention seemed to awake on every hand, and was not a whit daunted by the state of the money market. In 1834 Cyrus Hall McCormick had invented a reaper,

to be drawn by horses, which once for all solved and simplified the problem how the great plains and wide valleys of the West were to be brought under cultivation by a sparse pioneer population, where hands were few. In 1836 means were found by which the great anthracite coal beds of the country could be used in the production of steam and in the manufacture of iron. Along with the utilization of the new fuel came the invention of the screw propeller. By 1838 the invention had been fairly perfected, and it had become reasonably certain that steam craft upon the ocean would draw the continents of the world together as steam craft upon the rivers and locomotives upon the railways were uniting East and West in America. In 1839 James Nasmyth, at Manchester, invented the steam hammer whose use was presently to increase so enormously the power and resources of the iron forges from which the new machinery of conquest and manufacture was pouring forth.

Here were the instruments of industry and of real production upon which imagination dwelt and speculation based its hopes. Real wealth was being created apace, and nothing was too extravagant to hope for. More eager movements of population went with hope and enterprise, and a very ferment of social and economic change. With the growth of manufacturing industries came concentration also. Towns began to grow into cities. Enterprise took on a new magnitude, individual initiative was a little daunted, and corporations began to be multiplied. Finding themselves massed in the new undertakings, finding their employers, not individuals, but groups of men using their combined capital upon a large scale, workmen and mechanics began to draw together into protective organizations:

THE BANK AND THE TREASURY

and new murmurs against "capital, banks, and monopolies" disturbed the peace alike of philanthropists and of politicians. The rural nation which had chosen General Jackson to be its leader began to be transformed even while he reigned:—most of all in the East, where



Edgar A Poe

EDGAR ALLAN POE

industry was chiefly seated, but in the West also, where men of every section met, and moved with quickened pace towards new objects and new developments till then not dreamed of. New ambitions stirred everywhere, and men's very manners were changed with the new haste and energy that swept them on.

Men's minds and consciences were stirred, also, by the pungent airs of the new age. Not in America only, but throughout the whole European world also of which she was an outlying settlement, the attention of thinking men was set upon new thoughts in that day of change. The year 1830 had seen political and social revolution sweep to and fro, hardly to be checked, upon the troubled European stage. England had managed, as always, to be beforehand with revolution, but only by making many a radical change in her laws. Between 1828 and 1836 she repealed the Corporation and Test Acts, removed many of the political disabilities of Roman Catholics, reformed representation in Parliament, abolished slavery in her colonies, bettered her system of poor relief, framed a liberal code for the reconstitution of municipal corporations, and abolished tithes. In the United States there was none of these things except slavery to be cleared away. State and federal constitutions alike had been purged from the first of all that could clog or embarrass progress. American philanthropists, too, had been beforehand with the rest of the world in many a work of humanity and mercy. The fame of America's reformed penitentiary system had crossed the seas; and in 1831 Alexis de Tocqueville and Auguste Beaumont had come to the United States to report upon the system for the information of their government. It was that visit which gave us de Tocqueville's inimitable *Democracy in America*.

The abolition of slavery in the British empire in 1833 brought poignantly home to some men in the United States the one matter in which America was behind all the world. It was in 1833 that the American Anti-Slavery Society was formed, at Philadelphia. Not

THE BANK AND THE TREASURY

many connected themselves with it. Slavery was rooted deep in the whole economy of the South; the constitution of the Union itself was founded upon arrangements which took the permanence of slavery for granted; and no man who was not of hot crusading



Wm. H. Prescott

WILLIAM H. PRESCOTT

temper felt inclined to give any countenance to a movement which might, if pushed far enough, shake the very foundations of the government. But the few who gave themselves to the agitation were of crusading temper. Here and there throughout the country, moreover, there were bodies of men, like the Quakers,

whose principles had time out of mind been of this tenor, and who became at once their natural allies. Petitions began to pour into Congress praying that it would abolish slavery in the District of Columbia, prohibit the slave trade there, and break up the slave trade between the States. John Quincy Adams had entered the House of Representatives in 1831, only two years after he left the White House, as a representative of the Anti-Masons and Whigs of his home. A sturdy and striking figure he made, with all the dignity and all the contentious strength of his sixty-four years upon him; and it surprised no one, least of all his constituents at home, that he championed what he pleased, without respect of parties. It was he who presented the petitions against slavery and stood mettlesome and unalarmed amidst the wordy battles they brought on.

It was a deeply hazardous and ominous thing to join issue thus, though it were only upon a petition here and there, with regard to this central matter of the whole South's life. The South still stood unchanged. No revolution of industry, no breath of speculation, no plotting or building of railways, no steam craft at her ports or on her rivers touched or altered her fixed order of society. Some of the first railways built were built in the South. Her merchants felt the impulse and saw the outlook of the time as others did. But no power from without, no alteration of the world beyond her borders, could change her economic and social order so long as slavery lasted. There was no aristocracy in the South of the kind men commonly think of when they use the word. There was a ruling race and a subject race; there were rich men and poor among the race that ruled; there went with wealth a certain ease

THE BANK AND THE TREASURY

and expansiveness of living, a good deal of quiet leisure, an old-fashioned grace and punctiliousness of

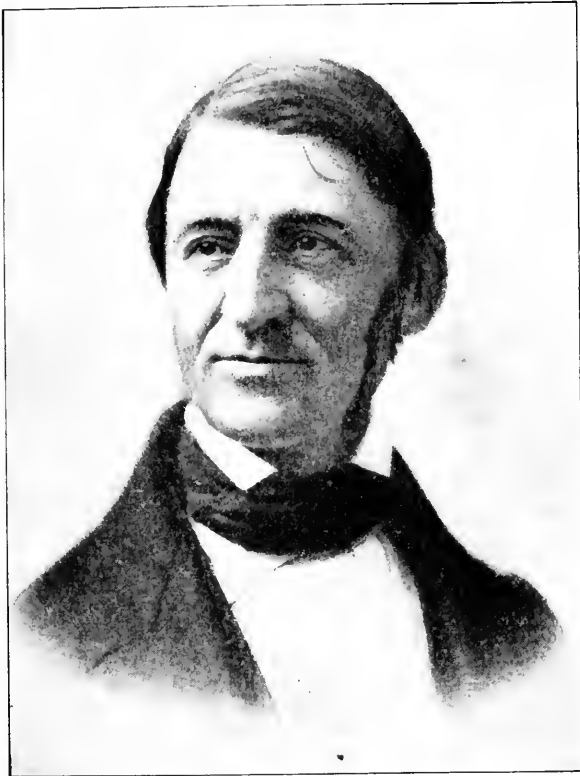

R. W. Emerson

RALPH WALDO
EMERSON

manner which gave to those who cultivated it an air of exclusiveness and elevation. Young men were apt to be arrogant and to have their fling in the world of pleasure, and old men showed sometimes a lofty pride

of birth and position. But there was little display. Wealth did not in that agricultural region mean abundant money, but only full store-houses, a well stocked stable, an unstinted table, plain comfort, and open-handed hospitality. In politics the ruling race were as democratic as men of their kind anywhere. All white men had an equal footing of privilege there and an equal freedom, though offices fell as often to men of position whom fortune had put at the front as to men who had made their way up from the ranks and men who added ambition and initiative to ability.

Mississippi and Alabama were still new States upon a frontier, and grew rapidly in population. Georgia, too, added slowly to her population from decade to decade, adding also to her industries and profiting as she could by the new forces of the age. But Virginia and the Carolinas grew scarcely at all. And so the South stood apart, potent and alive and yet immobile. Though she provoked attack, she was intrenched against it.

It was singular how the signs multiplied of change and a new age coming in. A whole generation of new writers came suddenly into prominence during those first years of railways and steam craft (1828-1841): Hawthorne, Poe, Whittier, Longfellow, Emerson, Lowell, Holmes, Prescott, Bancroft; Mr. Justice Story and Mr. Justice Kent; Henry Wheaton, Francis Lieber, Henry C. Carey; John James Audubon and Asa Gray,—men of letters, law writers, publicists, economists, men of science. Poe and Audubon were of the South; the rest were of the North, where leisure was coming with increase of wealth, stimulation of thought with increase of action. "You are a new era, my man, in your huge country," wrote Carlyle to Emerson. In

THE NEW YORK
PUBLIC LIBRARY

ASTOR, LENOX
TILDEN FOUNDATIONS

BOUNDARIES 1783 - 1850

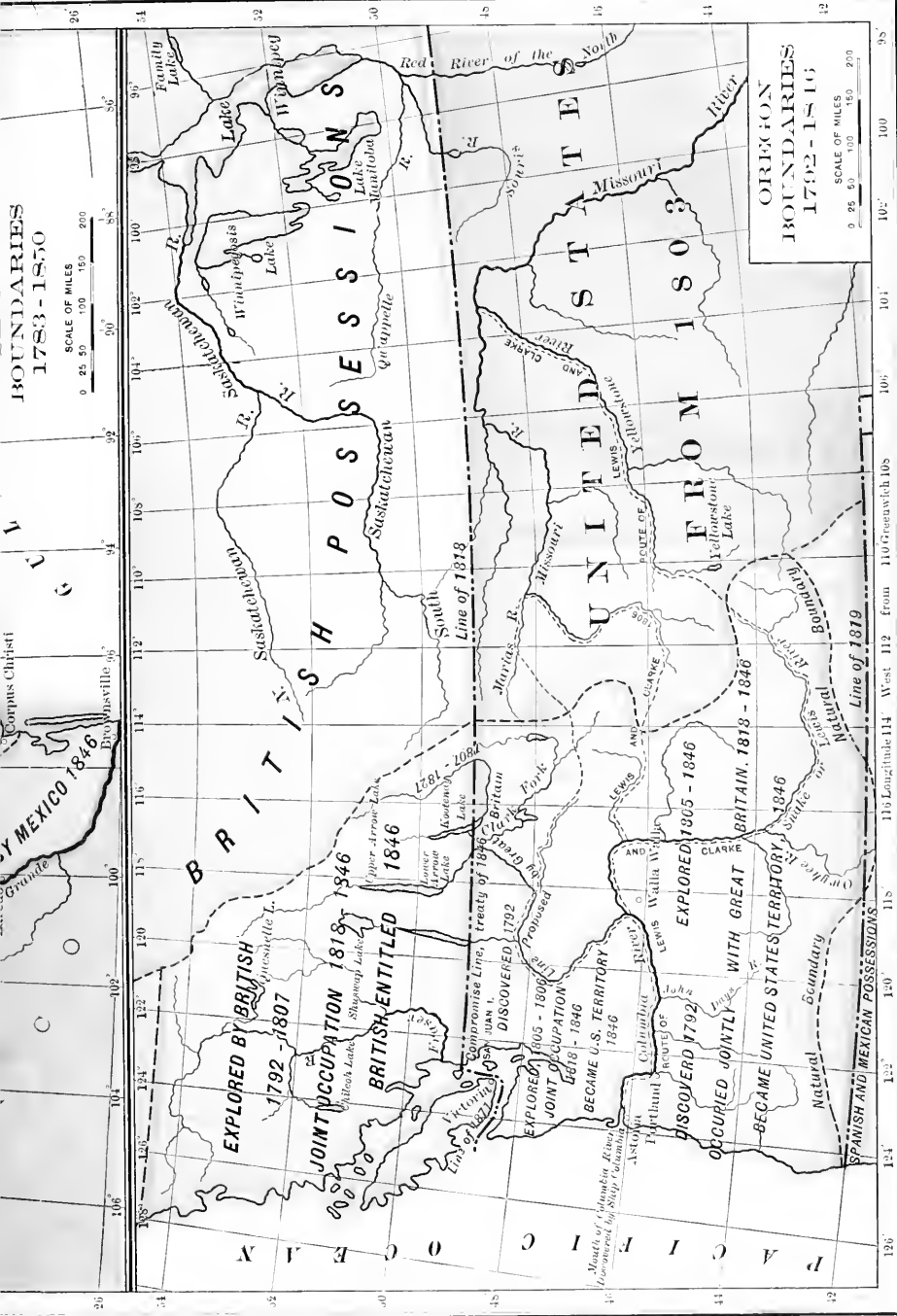

OREGON
BOUNDARIES
1792 - 1846



TERRITORIAL CONTROVERSY OF THE UNITED STATES, SETTLED BETWEEN 1783 - 1850

THE NEW YORK
PUBLIC LIBRARY
ASTOR, LENOX
TILDEN FOUNDATIONS

THE BANK AND THE TREASURY

the South writers still bent all their thoughts upon statesmanship and the control of public policy; read old books and maintained an elder taste; made cultivation a thing of quiet moments or of the delights of con-



J. R. Lowell

JAMES RUSSELL LOWELL

versation, and carried it forth into the open arena only as an instrument of power.

Every change seemed sensibly to increase the sweep and ascendancy of pure democracy and visibly to enhance the power of the general opinion. By the close

of General Jackson's presidency there was no longer any property qualification anywhere required in the North for the exercise of the suffrage except in Connecticut and New Jersey, or anywhere in the West except in Ohio. The people's day had come; the people's eyes were upon everything, and were used in a temper of criticism and mastery. Newspapers of a new type sprang up, like the *Sun* and the *Herald*, every number of which gave old gentlemen in New York a shock, which pried into everything and told everything, whether it concerned private individuals or public events. The upturning General Jackson had brought upon the government was beginning to come also upon society.

How serious the upturning had been in the administration of the government the country learned while Mr. Van Buren was President; and the discredit for what General Jackson had done fell upon him. The men whom General Jackson had put out of office had too often carried away with them the business methods of their Departments. The men who had succeeded them, always new and raw at their tasks, were too often incompetent also, and sometimes showed the cunning and dishonesty of men who seek the "spoils of office" for their own aggrandizement. It was Mr. Van Buren's misfortune that no discovery was made of the jobbery and misfeasance that had crept into the Departments until he became President. The "spoils" system, moreover, was commonly believed to have been the bad invention of his own school of politicians in New York. He attempted no concealments; no one was shielded or excused when discovery was made; but he got no credit for that. Everything that came to light was but con-

THE BANK AND THE TREASURY

firmation added to the conviction of the country that both he and his party had best be got rid of. The Whigs were eager to give legislative assistance to the



Nathl Hawthorne

NATHANIEL HAWTHORNE

country in its efforts to rally from the collapse of 1837; the Democrats offered nothing but the Independent Treasury,—were very fine and steadfast in their determination to take nothing but “sound” money into the Treasury, but offered no suggestion as to where the

A HISTORY OF THE AMERICAN PEOPLE

sound money was to come from, or how business was again to be founded on it.

The States were left to work that problem out for themselves, if legislation were needed; and a very wholesome change began. The legislatures of the States



Henry W. Longfellow

HENRY W. LONGFELLOW

set themselves at last to require real securities of the banks of issue which they chartered, New York leading the way; and by slow degrees credit was re-established, panic shaken off. But the Democrats gained nothing by the circumstance as a national party. They seemed to have lost initiative when they lost General Jackson.

THE BANK AND THE TREASURY

Mr. Van Buren had handled such diplomatic matters as fell to his management with prudence and good judgment. A final reckoning with the Seminole Indians of Florida had been brought to a successful close while he governed, and a serious boundary dispute with Great Britain had been accommodated, notwithstanding very distracting complications which had arisen out of attempts on the part of lawless men in the United States to assist insurgents who were openly in arms against the English crown in Canada. But only the irritating details of these matters were talked about. Nothing large or masterful filled the eye or stirred the general sympathy either in the President or in the men who spoke and acted for him in Congress; and the whole country turned to the Whigs for a change.

The Democrats nominated Mr. Van Buren for a second



PRESIDENTIAL TICKET, 1840

term and avowed all their negative principles in a candid platform. The Whigs, now at last welded into something like a united and aggressive party, nominated General Harrison, for whom most of them had voted four years before, for President, and for Vice President Mr. John Tyler, of Virginia. They made no declaration of



W H Harrison

WILLIAM HENRY HARRISON

principles whatever, but proposed only to oust the Democrats. The country was willing. General Harrison was the hero of a well remembered battle in which the redoubtable Tippecanoe, the "Prophet" of the Indians who hung upon the northwestern frontiers, had been routed, in 1811, and the western country quieted and made safe. He had himself been dubbed "Tippecanoe," and men everywhere were ready to shout

very lustily for "Tippecanoe and Tyler too." The Democrats had no enthusiasm with which to match this for the old soldier and honorable gentleman of the elder type whom their opponents had chosen as their candidate; had only their dimmed record to speak of; and lost overwhelmingly. General Harrison, it is true, got but forty-six thousand votes more than Mr. Van Buren

THE NEW YORK
PUBLIC LIBRARY

ASTOR, LENOX
TILDEN FOUNDATIONS

THE LOG

PUBLISHED SIMULTANEOUSLY

BY H. GREELEY & CO.



SATURDAY



W. H. Harrison

AN ELOQUENT RECORD.

WILLIAM H. HARRISON was born in Virginia, on the 9th of February, 1773.

In 1791, when 18 years of age, he was appointed by Washington an ensign in the army.

In 1792 he was promoted to the rank of lieutenant. In 1793 he joined the legion of General Wayne, and in the following campaign he was selected by him as one of his aids.

On the 24th of August, 1794, he distinguished himself in the battle of Miam, and gained the most illustrious military appellation from Gen. Wayne.

In 1795 he was made a captain, and was placed in command of Fort Washington.

In 1797 he was appointed by President Adams Secretary of the North-Western Territory, and resided in the present Territory.

In 1796 he was chosen a delegate to Congress. In 1801 he was appointed Governor of Indiana, and in the same year, President Jefferson, appointed him sole commissioner for treating with the Indians.

In 1800 he was appointed Governor of Indiana, &c.

In 1801 he was appointed Governor of Indiana, &c.

In 1801 he was appointed Governor of Indiana, &c.

and in 1801 he was appointed Governor of Indiana, &c.

In 1801 he was appointed Governor of Indiana, &c.

In 1801 he was appointed Governor of Indiana, &c.

In 1801 he was appointed Governor of Indiana, &c.

In 1801 he was appointed Governor of Indiana, &c.

In 1801 he was appointed Governor of Indiana, &c.

In 1801 he was appointed Governor of Indiana, &c.

In 1801 he was appointed Governor of Indiana, &c.

In 1801 he was appointed Governor of Indiana, &c.

In 1801 he was appointed Governor of Indiana, &c.

STANDISH OF G

No. 1. "Gen. H. H. into 1

Of the many noble

of the many noble

of the many noble

of the many noble

of the many noble

of the many noble

of the many noble

of the many noble

of the many noble

of the many noble

of the many noble

of the many noble

of the many noble

of the many noble

of the many noble

of the many noble

of the many noble

of the many noble

of the many noble

of the many noble

of the many noble

of the many noble

of the many noble

of the many noble

of the many noble

of the many noble

of the many noble

of the many noble

of the many noble

of the many noble

of the many noble

of the many noble

of the many noble

of the many noble

of the many noble

of the many noble

of the many noble

of the many noble

of the many noble

of the many noble

of the many noble

of the many noble

of the many noble

of the many noble

of the many noble

of the many noble

of the many noble

of the many noble

of the many noble

of the many noble

of the many noble

of the many noble

of the many noble

of the many noble

of the many noble

of the many noble

of the many noble

of the many noble

of the many noble

of the many noble

of the many noble

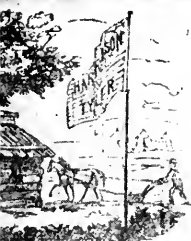

CABIN.

IN NEW-YORK AND THE NORTH.

NO. 1.

MAY 2, 1840.

HARRISON GUERRE VOTED TO SELL WHITE MAN FOR DEBT.

Mr. Guerre, a member of the Legislature, has voted in favor of a bill which would sell a white man for debt. This is a measure of the most oppressive and tyrannical nature. It is a bill which would make a man's property his own, and would allow him to be sold for his debts. This is a bill which would make a man's property his own, and would allow him to be sold for his debts. This is a bill which would make a man's property his own, and would allow him to be sold for his debts.

It is a bill which would make a man's property his own, and would allow him to be sold for his debts. This is a bill which would make a man's property his own, and would allow him to be sold for his debts. This is a bill which would make a man's property his own, and would allow him to be sold for his debts. This is a bill which would make a man's property his own, and would allow him to be sold for his debts.

It is a bill which would make a man's property his own, and would allow him to be sold for his debts. This is a bill which would make a man's property his own, and would allow him to be sold for his debts. This is a bill which would make a man's property his own, and would allow him to be sold for his debts. This is a bill which would make a man's property his own, and would allow him to be sold for his debts.

It is a bill which would make a man's property his own, and would allow him to be sold for his debts. This is a bill which would make a man's property his own, and would allow him to be sold for his debts. This is a bill which would make a man's property his own, and would allow him to be sold for his debts. This is a bill which would make a man's property his own, and would allow him to be sold for his debts.

It is a bill which would make a man's property his own, and would allow him to be sold for his debts. This is a bill which would make a man's property his own, and would allow him to be sold for his debts. This is a bill which would make a man's property his own, and would allow him to be sold for his debts. This is a bill which would make a man's property his own, and would allow him to be sold for his debts.

It is a bill which would make a man's property his own, and would allow him to be sold for his debts. This is a bill which would make a man's property his own, and would allow him to be sold for his debts. This is a bill which would make a man's property his own, and would allow him to be sold for his debts. This is a bill which would make a man's property his own, and would allow him to be sold for his debts.

EDITED BY HORACE GREELEY

THE NEW YORK
PUBLIC LIBRARY

ASTOR, LENOX
TILDEN FOUNDATIONS

THE BANK AND THE TREASURY

received out of a total of nearly two and a half millions; but, though his margins were slender, counting by voters, he won in the electoral college by a majority of one hundred and seventy-four out of a total of two hundred and ninety-four (234-60). The Whigs saw their day dawn at last, and the Jacksonian régime was over.

The *authorities* and *sources* for the events of this chapter are the same as those named under Chapter II. The following special authorities should, however, be added: the second volume of Albert S. Bolles's *Financial History of the United States*; Richard Hildreth's *Banks, Banking, and Paper Currency*; William G. Sumner's *History of American Currency*; Edward G. Bourne's *Surplus Revenue of 1837*; Goddard's *Bank of the United States*; C. F. Dunbar's *Laws Relating to Finance*; Shosuke Sato's *Land Question* in the fourth volume of the *Johns Hopkins Studies in Historical and Political Science*; and Samuel Tyler's *Life of Roger B. Taney*.

III

THE EXTENSION OF SLAVERY

IT remained to be seen whether the forces bred in the Jacksonian time were also spent and gone, with the passing from office of the men who had personified them. It was difficult to reason upon cause and effect amidst such scenes of change. Unquestionably a veritable revolution had been wrought in American politics and social action while Jackson and his partisans ruled in affairs; but who could say whether these men had been products or causes of that revolution? No doubt there had been an air of lawlessness in the headstrong action of the uncompromising, frontier soldier who had been President. The fruit of his rough handling had shown itself obviously enough during the mild reign of his lieutenant and successor. And the country had seemed to take its cue from General Jackson. Riot and brawling disorder had everywhere been thrust into affairs with unexampled boldness, success, immunity from punishment. Headstrong men sought everywhere to take the law into their own hands and do what seemed best in their own eyes,—used force to win strikes against their employers, to carry elections, to silence abolitionist agitators and drive free negroes out of the cities, to destroy the power of the Roman Catholics coming in at the ports, to punish offences

THE EXTENSION OF SLAVERY

which the courts too slowly dealt with or let go by, to get food when prices rose too high. Men fought in armed bands in city streets because they were of opposite

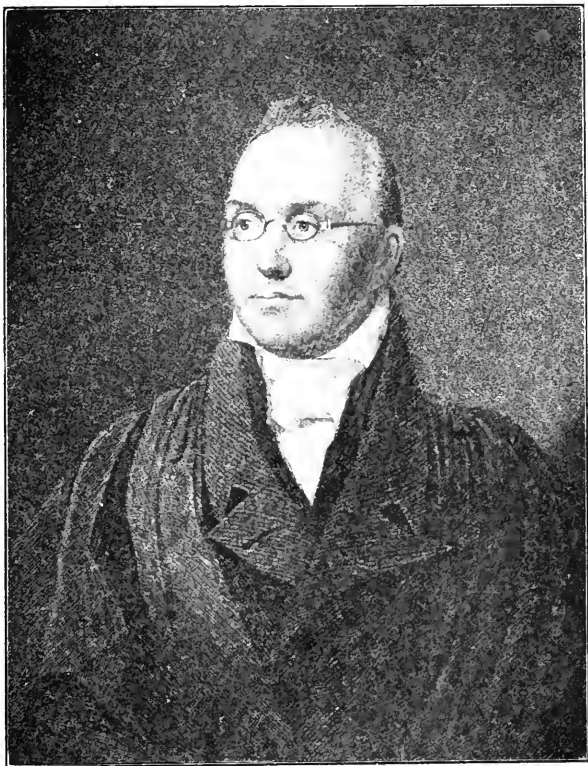

Joseph Story

JOSEPH STORY

religious creeds or rival political factions or antagonistic races, the native against the immigrant, the Protestant against the Roman Catholic. On a memorable night in August, 1834, an Ursuline convent in Charlestown,

within sight of the rising shaft on Bunker Hill which was to mark the dawn of liberty in America, had been sacked and put to the torch, because of the rage of a Protestant mob against the growing power of the Romish church, coming in with the Irish immigrants; and the officers of the town had stood inactive by.

No man could justly say that General Jackson stood for such things. He kept the law, as he understood it, very punctiliously and with a fine sense of honor, and made others keep it also. His challenge was only to those who opposed him in matters of policy or in the application of law, or sought to put upon him the too formal restraints of judicial decision. Those who judged calmly of affairs saw alike in him and in the uneasy disorders of the time only signs of one and the same thing. In the new democracy which Jackson represented the mass of common men took leave to assert themselves in all things, and use their own standards of right; brushed law aside upon occasion to get at their object; sought to rectify abuses by direct blows of force,—the force of voting numbers or the force of arms. No doubt riots grew more common in Jackson's second term than they had been in his first, and seemed to keep pace with his fight against the Bank, his arbitrary use of authority in reaching his ends concerning it, his ruthless dealings with the credit of the country. No doubt, too, his friends and partisans spoke too foolishly and too much like demagogues of "the natural hatred of the poor to the rich." But great economic forces moved also with equal pace towards change and disturbance. The relations of capital and labor were altered, whether General Jackson acted or not; prices rose and wages shifted by laws he did not understand.

THE EXTENSION OF SLAVERY

Railways changed the course and the speed of the nation's life; enterprise set men's minds upon every bold adventure; men of every kind flung conservatism off and became radical, reckless, ungoverned in action. Cause and effect were not in such a day to be easily distinguished. No one could say what was permanent, what merely temporary and accidental in the new and novel order. One thing only was evident, that a new and irregular fervor and a new standard of action had been brought into affairs.

The Whigs themselves had conformed. They had come into power in masquerade. Instead of putting one of their real leaders forward for the presidency, they had nominated a western soldier, whose rugged strength and simple claim upon the admiration of the country had made him a popular favorite. They had themselves played the rôle of a reforming Opposition merely, whose mission it was to turn a company of sophisticated politicians out of office, with all their corrupt and incapable following, and put a simple man of the people in,—a Whig Jackson. Their campaign had been conducted without serious debate or proposals of policy; had been a mere noisy round of torch-light processions, merry-making barbecues, and boisterous neighborhood rallies. Their emblem had been the frontier log cabin and a keg of hard cider, the solacing drink of the frontiersman. It was a masquerade of pure democracy, in the new taste, and they had played it out to perfection.

But when the election was over and they had won, the costumes of the play were put by. At last they were assured of majorities in both houses of Congress; small majorities, indeed, — in the House, twenty-five,

in the Senate, six,—an uncomfortable reminder of the narrow margin of votes by which they had won; but a working majority, none the less; and the real leaders of the party, once more free to speak their serious purposes, came forward with the programme by which they meant to carry the government back to the traditions which the Democrats had ruthlessly broken.

That programme included the repeal of the Independent Treasury Act, the establishment of a new national bank, the authorization of an immediate loan for the relief of the Treasury, a system of new tariff duties to supply the government with a permanent revenue, and the distribution among the States of the proceeds of the sales of the public lands. The financial distress of the time had touched the government somewhat sharply, and General Harrison's first act was to summon Congress to meet in extraordinary session on the last day of May, to consider measures of relief.

But before it could assemble he was dead, and every plan at which he was to have assisted had fallen into confusion. The excitement and the fatigues of the campaign for the presidency, capped by the infinite worry and exhaustion that came upon him like a flood when hordes of office seekers and advisers began to crowd about him after his election and induction into office, proved too much for his strength at sixty-eight. He suddenly sickened, and exactly one month after his inauguration (April 4, 1841) was dead.

John Tyler was President, to whom no Whig had looked for leadership. He was a southern Democrat; had been opposed to the Bank upon principles of public policy, as General Jackson had been, but had held off from his leader in the matter of the deposits and had

THE EXTENSION OF SLAVERY

disapproved his reckless blows at credit, no less than his masterful attitude towards Mr. Calhoun and the doctrines held in South Carolina; and had been named Vice President with General Harrison only because Whigs of Mr. Clay's stamp knew that they had in their following many men who were not in all matters of



CAMPAIGN SYMBOL OF 1840

their way of thinking, and were uneasily aware that their party was but a conglomerate party of opposition, to which the votes of such discontented or independent southern Democrats as Mr. Tyler would be very serviceable. And so the masquerade of the campaign had had a touch of prophecy in it, after all: here were the triumphant Whigs with a Democratic President!

Their programme, of course, hopelessly miscarried. Mr. Tyler felt very keenly the delicacy of his position, and the almost necessarily compromising character of the middle course he felt bound to attempt. Nature and habit forbade him the frank, straightforward, unhesitating course which alone could have won him prestige and credit. He had neither initiative nor audacity enough for leadership; tried soft-spoken diplomacy where he should have used candid avowals of his real opinion; courted compromise and accommodation only to reject them at last; insisted upon his own views only after he had created the impression that he would yield them; seemed false and insincere because he parleyed so long before taking his stand; and pleased no one, not even himself. He had been glad to see the Bank's charter expire in 1836, and did not wish to see the Bank re-established now; but the Whig leaders were his advisers; he felt and showed a real desire to yield everything he could that stood in the way of their plans. Conference followed conference in the matter of the Bank, for upon that everything hinged; twice he seemed about to meet their wishes; twice he failed them. A bill was drawn and passed in which several features of the old charter were modified to suit his views, but he vetoed it (August 16, 1842). Another bill was drawn and passed which made concessions still more radical to his scruples, but again he vetoed it (September 9th). Each time he hesitated; each time his friends said that he would sign the bill; each time he fell back at the moment of final action, as was his wont, upon his real convictions.

The Whigs in Congress were inexpressibly chagrined and exasperated; publicly declared, with an unmis-

THE EXTENSION OF SLAVERY

takable note of passion, that "all political connection between them and John Tyler was at an end from that



John Tyler JOHN TYLER

day forth"; and sullenly saved such remnants of their programme as they could. Even before the open breach came the leaders of the party had drawn away from

him, and he had been cut off from all real intimacy of counsel with the men whom Congress heeded. General Harrison had associated with himself a cabinet made up of men who were known to be accredited spokesmen of the party, making Mr. Webster, whom half the country regarded as the greatest of Whigs, his Secretary of State; and Mr. Tyler, sincerely desirous of making as slight a break as possible in the continuity of the party's policy, had asked these gentlemen to retain their places. But even before his final veto of the Bank bill they had found it impossible to regard themselves as really in his confidence. By the middle of September, 1841, all of them had withdrawn except Mr. Webster, who remained only until important negotiations with England touching the northeastern boundary should have been brought to a successful issue. The Whigs had in effect withdrawn their hands from the Executive. Not only was the President's leadership gone, but the best traditions the Whig leaders stood for, of a policy which joined Congress and the Executive under a common leadership, were broken, and affairs were set adrift to take the chance currents of politics.

The President signed the bill for the repeal of the Independent Treasury Act, consented to the necessary loan and to the changes in the tariff which had been planned, and agreed to the distribution among the States of the moneys received from sales of the public lands. But, without the bank, these measures lacked all constructive efficiency. The Independent Treasury arrangements having been set aside, and no other fiscal agency having been provided or authorized, the way in which the revenues should be kept and handled was left entirely to the discretion of the Treasury, without

THE EXTENSION OF SLAVERY

guidance or restraint of law, throughout all the rest of Mr. Tyler's administration.

The Whig tariff Act was passed at the regular session of 1841-1842. It incontinently upset the compromise arrangements of 1833. The Act of 1833 had provided

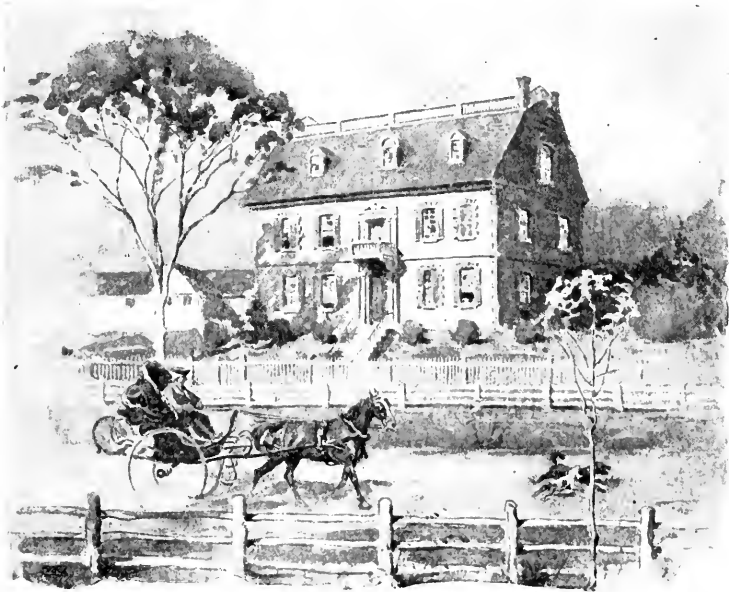

THE HANCOCK HOUSE, BOSTON. FROM A SKETCH MADE IN 1833

for a progressive reduction in the rates of duty which should be complete by the first of July, 1842, when the rates should have reached a uniform level of twenty *per cent*. The Whigs suffered them to stay at that level only two months. On and after the first of September following, it was enacted, the rates were to be increased again, for the sake of the revenue. Twice the President vetoed the bill, because of provisions contained in it of

which he did not approve. It was passed a third time, without the provisions he objected to, and he signed it.

From the outset, so soon as the democratic masquerade with which they had come in was over, opinion had run against the Whigs. So early as the autumn of 1841 local elections had begun to go against them in States which they had but just now carried for General Harrison; and the mid-term elections of 1842 swept away their majority in the House of Representatives. It had been but twenty-five; it was supplanted now by a Democratic majority of sixty-one,—a loss of forty-three seats. The Senate they still held by a narrow margin; but, without the House, they could do nothing of consequence. Their dream of reconstructing the old régime from which the Democrats had torn the country away was rudely dissipated.

The Whig leaders were now to find out what changes of politics had come to stay. They had not perceived that what they had witnessed under General Jackson was not a temporary madness of reaction against the statesmanship and the ideals of the generation which had given the nation its first form and policy, but a permanent shifting of points of view, for men in office and out, a turning away once and for all from the old to new questions that went with the making of the nation. Whether they would or no, they were in the hands of the new democracy, their fortunes as a party committed to the swift changes of the passing time. Important as the matters were with which they dealt, their programme had been a programme of old questions, not of new. Change worked too swiftly now to make it any longer possible for any party, however led or constituted, to hark back to the policy of a time twelve

FREEMEN AWAKE!

27

WOULD YOU SUSTAIN THE UNION; PRESERVE ORDER, TRANQUILITY
AND CHRISTIAN FEELING IN YOUR RESPECTIVE CHURCHES AND CON-
GREGATIONS; AND SECURE PEACE AND HAPPINESS
AMONG YOUR DOMESTIC FRIENDS!

THEN

"TO THE RESCUE!"

(and defeat the
revolutionary
scheme of a
decentful gang
of hypocrites,

THE
DEVIL
IS IN THE
CAMP!

leading traitors
and dark-hearted,
wiping, amalga-
mation dem-
(pages)

AND MAINTAIN YOUR POSITION!

"AND INDIGNANTLY BRING UPON THE FIRST DAWNING OF EVERY ATTEMPT
TO ALIENATE ANY PART OF OUR COUNTRY FROM THE REST,
OR TO ENFEBLE THE ARMS OF THE UNION WHICH NOW
LINK TOGETHER THE VARIOUS PARTS."

PHILADELPHIA

1839

PRICE 10 CENTS

years gone by. There had been transient humors, no doubt, as well as permanent alterations of fortune, in Jackson's day: things which came with the heady excitements of the time and sank away again as affairs steadied to the new order. But, though passions subsided and hasty errors fell away from men's thoughts as the air cooled and cleared, all things kept their new face, and the reckonings of politics could no more be forced back to their old scale than the reckonings of trade or the operations of credit. It was made evident enough while Mr. Tyler sat out his unexpected presidency that the questions which cried for settlement were no longer questions of banking and currency, or even questions of tariff, but the fundamental institutional choices of mere growth: the questions which went inevitably with the setting up of every new State and the occupation of every new piece of territory.

It was this making and remaking of the country that had upset the old order of politics and brought the untempered airs of the West into all forecasts of the political weather. Half the economic questions of that day of change took their magnitude and significance from the westward expansion. It was in the new regions of the country, with their undeveloped riches inflaming the imagination, that speculation ran its reckless course with the most incorrigible hardihood. Railways outran population and failed as investments because settlement spread rather than compacted. Statesmen had always to be studying some law of growth, checking or indulging some wild adventure of enterprise. And there was in the midst of all a fundamental choice which did not alter like the rest.

The chief choice always to be made at every stage

THE EXTENSION OF SLAVERY

of the unhalting westward movement was the choice concerning slavery: the choice which had been debated very temperately at first when the great Ordinance for the government of the Northwest Territory was adopted in the days of the Confederation, but which had struck many a spark of passion out when handled again at the admission of Missouri into the Union, and which seemed every time it was touched more dangerous and disturbing than before. Now it seemed to lie everywhere at the front of affairs,—not the question of the abolition of slavery, but the question of its territorial extension. The men who had formed the Anti-Slavery Society were frank abolitionists; demanded much more than the mere limitation of the area of slavery; set themselves to make sentiment for its absolute destruction. But their ranks were sparsely filled, and their agitations did little but offend a practical, law-abiding people. Every man who knew aught of affairs knew the tenor of the constitution in that matter. Slavery within the States which were already members of the Union was an institution with which the federal government could have nothing to do, which no opinion even could touch or alter save the opinion of the States concerned: a question of domestic law in respect of which the choice of each little commonwealth was sovereign and final. Had the full roster of the States been made up, agitators in Congress would have found themselves obliged to confine their attacks to the slave trade in the District of Columbia and the commerce in slaves between the States. But the full roster of the States was not made up: all the great Louisiana purchase remained to be filled with them; and with the making of every community there must come again this question

of the freedom of labor or the extension of slavery. The fateful choice was always making and to be made.

The Whig leaders were profoundly disturbed to see it thrust forward in very practical shape, made a thing to be faced squarely and at once, by the President whom they had undesignedly put into office. In April, 1844, Mr. Tyler sent to the Senate a treaty of annexation which he had negotiated with Texas. Secret negotiations, a piece of business privately carried to completion and made public only when finished, suited well with the President's temper and way of action. A man naturally secretive, naturally fond, not of concealments, but of quiet and subtile management, not insincere, but indirect in his ways of approach, he relished statecraft of this sort, and no doubt liked the Texan business all the better because it seemed to demand, in its very nature, a delicate and private handling. The Senate rejected the treaty by the very decisive vote of 16 to 35, men of both parties alike deeply irritated that the President should spring this weighty matter upon the country in such a fashion, taking no counsel beforehand save such as he chose to take. But the question, once put definitely forward, could not be thrust aside again. It was too vitally connected with the mastery of the continent, too plainly a thing which lay at the heart of western plans, to be put aside by vote of the Senate. It had come to be fought out as a party issue; and the Democrats were better prepared for it than the Whigs. They were at least capable of exercising choice. The Whig party was too curiously and too variously compounded to meet any new question without painful hesitation and deep embarrassment.

Texas had sprung up, a young empire at the south-

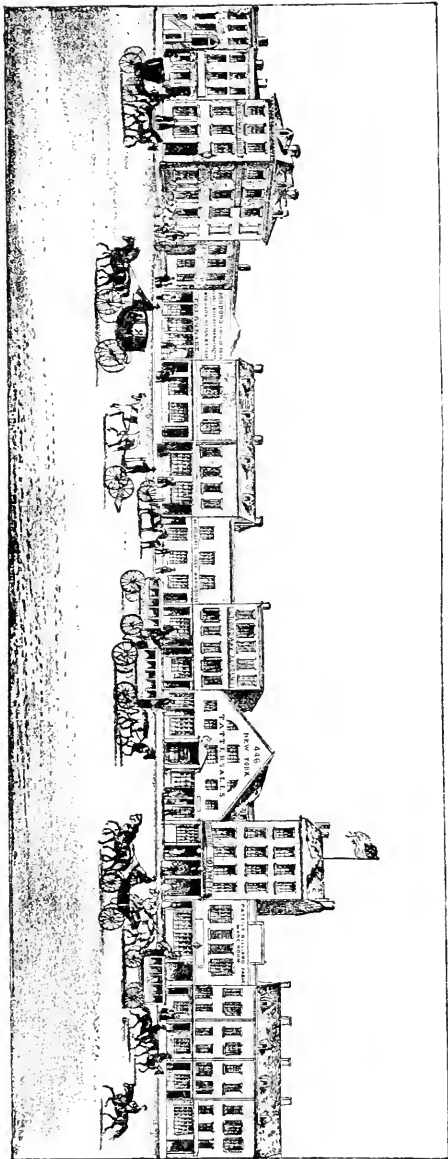

BROADWAY, EAST SIDE, BETWEEN GRAND AND HOWARD STREETS, NEW YORK, 1840

west, within a decade. No doubt all the vast region which she claimed and dominated had in strict right been a part of the broad, vague "Louisiana" which Mr. Jefferson had purchased of France in 1803; but the United States had yielded their claim to it in 1819, in order to secure all of Florida in the treaty with Spain. Mr. Adams, then Secretary of State, New Englander though he was, had wished to insist upon setting the southwestern boundary of the United States forward to the Rio Grande del Norte; but Mr. Monroe, the President, southerner though he was, had thought it best, as the rest of his cabinet did,—Mr. Crawford, of Georgia, Mr. Calhoun, of South Carolina, and Mr. Wirt, of Virginia, among them,—that the East should not be so disquieted. "Having long known the repugnance with which the Eastern portion of the Union have seen its aggrandizement to the West and South," wrote Mr. Monroe to General Jackson, "I have been decidedly of the opinion that we ought to be content with Florida for the present." He had seen then that it was only "for the present"; and he had irritated the South and West more than he had pleased the East. By abandoning a full third of the Louisiana claim he had made the Missouri compromise of the next year (1820) no settlement at all, but merely a new point of departure in the struggle for the extension of slavery and the expansion of the South. In the drawing of that line of compromise the southern men had gained hardly so much as one fourth of what had been conceded to the northern interest, and the balance of power between the sections remained still to be redressed.

Texas did not remain the property of Spain. While the treaty of 1819 lay unconfirmed at the dilatory court

THE EXTENSION OF SLAVERY

of Madrid, the people of Mexico broke away from their allegiance to the crown of Spain (1821) and established their independence, sweeping Texas within their dominion. In 1825 Mr. Adams offered Mexico a million dollars for the territory, but got nothing for his offer but the jealous distrust of the new government. General Jackson offered five millions for it, and only intensified the distrust. In 1827 the "State of Coahuila and Texas" became a member of the Mexican federal union.

At first, to get increase of strength in her struggle with Spain, Mexico had encouraged immigration out of the United States. At first her law permitted slavery. When she grew fearful of the too strong desire of the United States for Texas she shut her doors, so far as law and ordinance could shut them, against immigrants out of the East. To win favor with the negroes of Hayti against Spain, she abolished slavery. But immigrants were not to be gainsaid; that long border could neither be watched nor guarded. Slaves came with their masters, too, and Mexican laws had to be suspended for the benefit of the Americans, who would not heed them.

The masterful men who poured in across the long border came for the most part from the southern States. They found Mexican rule a thing sore to bear, arbitrary, inconstant, without principle, without stability of power. As their numbers increased, therefore, they made bold to take things into their own hands; framed a constitution for Texas which was to their own liking; and, when they could not obtain the sanction of the Mexican government for it, put it into operation without sanction (1833), making a revolution out of the right of local self-government. In 1836, the government of Mexico being overturned and Santa Anna, its President, made dictator

in his own behoof, they seceded, and made good their independence in a battle (San Jacinto, April 21, 1836) which the usurper was not likely to forget. With bowie



*Ante. Lopez
Santa Anna*

GENERAL SANTA ANNA

knives and clubbed rifles, a little army of seven hundred and forty-eight Texans, under the redoubtable Sam Houston, fell in true frontier fashion upon the sixteen hundred Mexicans Santa Anna had brought against

them; left about six hundred of their enemies dead upon the field; gave themselves more than two hundred wounded Mexicans to take care of when the dreadful work was over; took seven hundred and thirty prisoners; and had the dictator himself to show for trophy. Of their own number but six were killed and twenty-five wounded. "I was thirty years too soon!" cried Aaron Burr, when the news was brought him in his solitude,—an aged man, ostracized, forgotten.

The European states which coveted her trade recognized the independence of Texas the next year (1837). General Jackson recognized it as promptly. He took counsel, after his masterful fashion, neither with Congress nor with any one except the friends of Texas herself. He was himself General Houston's friend, and had no doubt what countenance the Executive of the United States should give the chief of the new state. Texas was her own mistress in her own empire.

But the men who had peopled her out of the South had not taken possession of her government to maintain themselves in independence. They had taken possession in order to bring the fair territory into the Union to which they conceived her properly to belong. Her broad expanses were the natural growing ground of the South. The political advantages the South would reap from the addition of Texas to the Union were palpable and obvious,—so palpable and obvious that politicians in the East deemed her virtual conquest by southern men a concerted scheme for southern aggrandizement. Only by the addition of territory and the creation of new states south of the line drawn by the Missouri compromise could the South hope to preserve that equality between the sections in the Sen-

ate upon which she instinctively felt her safety, the integrity and even the continuance of her chosen ways of life, to depend. The vast area of Texas, big enough for half a dozen states, would be a make-weight indeed, and was a stake worth playing for. It looked to the rest of the country as if the South had deliberately played for it, using lawless and ambitious men as pieces in the game. It was said that General Houston had gone from his home in Tennessee, a disappointed and discredited man, expressly "to kindle an internal insurrection" out of the inflammable material sent ahead of him, "and separate Texas from Mexico." Like every frontier, the country teemed with men come for adventure, and not too squeamish of what sort it should be. Those who were suspicious felt sure they had come for a particular adventure planned beforehand,—that Texas had been garrisoned with conspirators to serve the ambition of the South. She had in fact come by her settlers out of the States like any other frontier. Her independence came as inevitably as the unpalatableness of Mexican authority to the temper of the new comers. The proposal to bring her into the Union came from men who had taken possession of her, not to secure independence, but only a new home where they should be as free as Americans within the border they had crossed. The matter had been broached to Mr. Van Buren; but he had read the signs of the times and had declined to have anything to do with it. Mr. Tyler took it up with a certain eagerness. A southerner himself, bred to the southern point of view, holding the constitutional doctrines of the South very absolutely and in a form almost as radical and unqualified as that in which Mr. Calhoun, now his Secretary of State,

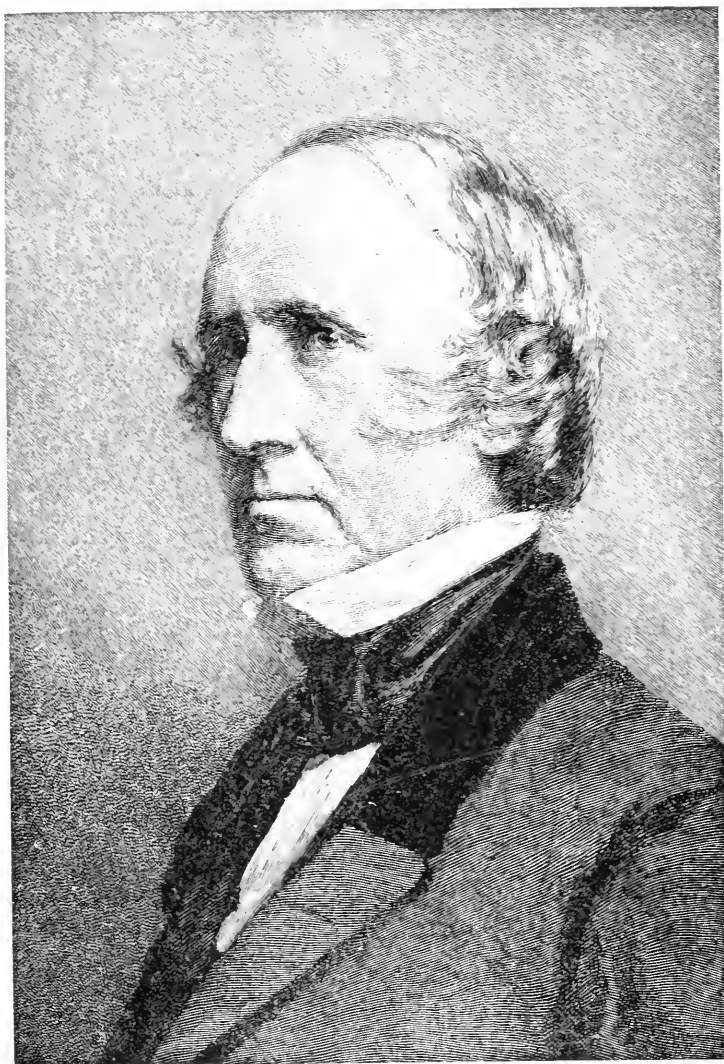

Wendell Phillips

WENDELL PHILLIPS

had uttered them, in defence of nullification, and minded to maintain the old balances of the federal system where he could, the annexation of Texas seemed to him a step which every statesman should wish to take.

Texas stood ready to accept a separate rôle should her overtures be rejected. Should the jealousy of warring parties exclude her from the Union, "a rival power will soon be built up," said General Houston, "and the Pacific as well as the Atlantic will be component parts of Texas in thirty years. . . . All the powers which either envy or fear the United States would use all reasonable exertions to build us up as the only rival power that can exist on this continent." The long coast of the Pacific above her was open to be occupied: she could look forward to having the Californias and New Mexico for the taking. "They must come," her confident leader declared; "it is impossible to look on the map of North America and not perceive the rationale of the project."

But she was not left to try the experiment. Though the treaty which he submitted to the Senate failed when it came to the vote, in June, 1844, Mr. Tyler had brought Texas in within less than a twelvemonth after its rejection. The summer of 1844 had brought together again the nominating conventions of the parties, to make ready for the next presidential election; and the Senate had waited to vote as the Whig convention should wish it to vote. The Whig convention had said nothing about the annexation of Texas in its declaration of principles, but it had put Mr. Clay in nomination for the presidency, and Mr. Clay, whom all the party knew to be its real leader, had decided against any immediate step towards annexation. The Democratic convention,

FIFTY REASONS
WHY THE
HONORABLE HENRY CLAY
SHOULD BE
ELECTED PRESIDENT
OF THE
UNITED STATES.
BY AN IRISH ADOPTED CITIZEN.

"The honest, patient, and industrious German readily unites with our people, establishes himself on some of our fat lands, fills a capacious barn, and enjoys in tranquillity the abundant fruits which his diligence has gathered around him, always ready to fly to the standard of his adopted country, or of its laws, when called by the duties of patriotism. The gay, the versatile, the philosophical Frenchman, accommodating himself cheerfully to all the vicissitudes of life, incorporates himself without difficulty in our society. But, of all foreigners, none amalgamate themselves so quickly with our people as the natives of the Emerald Isle. In some of the visions which have passed through my imagination, I have supposed that Ireland was originally part and parcel of this continent, and that by some extraordinary convulsion of nature it was torn from America, and, drifting across the ocean, it was placed in the unfortunate vicinity of Great Britain. The same open-heartedness, the same careless and uncalculating indifference to our own life, characterizes the inhabitants of both countries. Kentucky has been sometimes called the Ireland of America. And I have no doubt that, if the emigration were reversed, and set for America upon the shores of Europe, every American emigrant to Ireland would there find, as every Irish emigrant here finds, a hearty welcome and a happy home."

Extract from Mr. Clay's Speech in the Senate, Feb. 1830.

BALTIMORE:
PRINTED FOR THE AUTHOR.
1844.
MURPHY, PRINTER.

more bold and candid than the Whig, declared very flatly for "the reoccupation of Oregon and the reannexation of Texas at the earliest practicable period" and made those critical matters distinct as the real issues of the campaign. Unable to agree upon any one of the recognized Democratic leaders for the presidential nomination, it named Mr. James K. Polk, of Tennessee, as the candidate of the party, a man long prominent in the Democratic ranks in the House of Representatives, and an avowed advocate of annexation. Mr. Clay shifted uncomfortably as the fight went forward; explained his position overmuch; sought to conciliate opinion on both sides; and lost support where he had seemed most likely to receive it. The abolitionists had brought a "Liberty" party into existence, and now put a candidate of their own into the field. They drew their strength more from the Whigs than from the Democrats, and their ranks were swelled more and more as Mr. Clay made doubting Whigs more and more uneasy. Their sixty thousand votes decided the election. Mr. Polk spoke but one purpose, showed himself a frank, unhesitating party man, held his followers to an open path, and, by narrow majorities, won in fifteen out of the twenty-six States.

It was when the campaign was over and the election decided that Mr. Tyler had the satisfaction of himself bringing Texas into the Union. The country had given its verdict; the houses, accepting the verdict, passed a joint resolution in favor of the admission of Texas; and the President signed the resolution on March 3, 1845, the day before Mr. Polk entered upon the succession.

It remained for Mr. Polk to deal with the consequences.

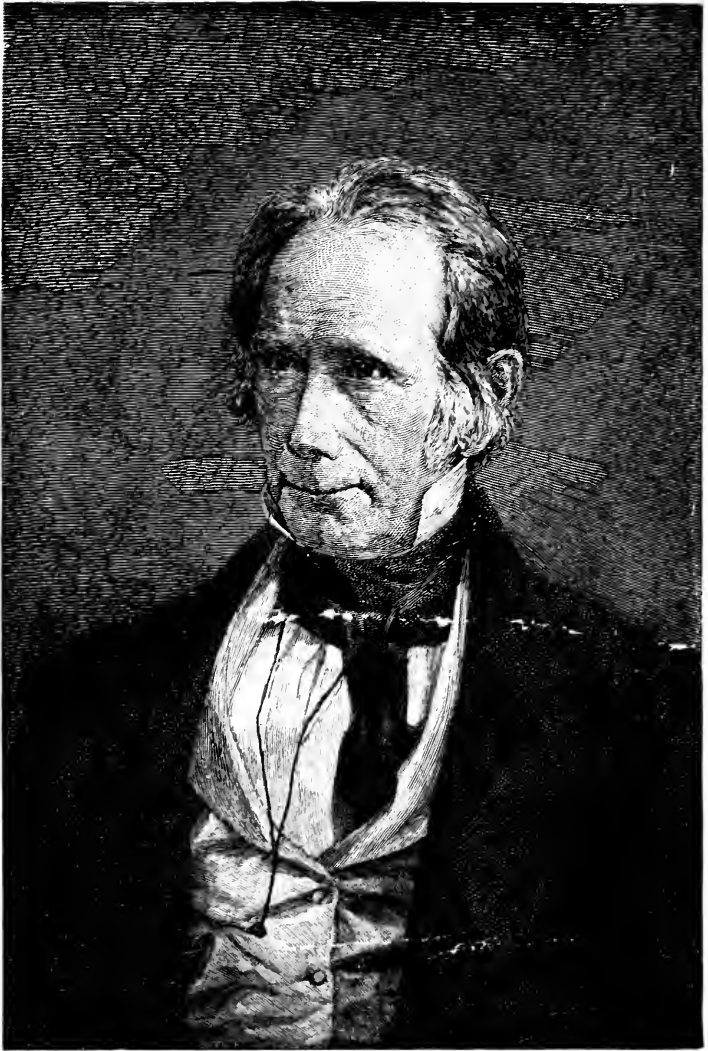

J. Cas

THE NEW YORK
PUBLIC LIBRARY

ASTOR LENOX
TILDEN FOUNDATIONS

THE EXTENSION OF SLAVERY

The programme of his party seemed to have saddled two wars upon him. Mexico would quite certainly

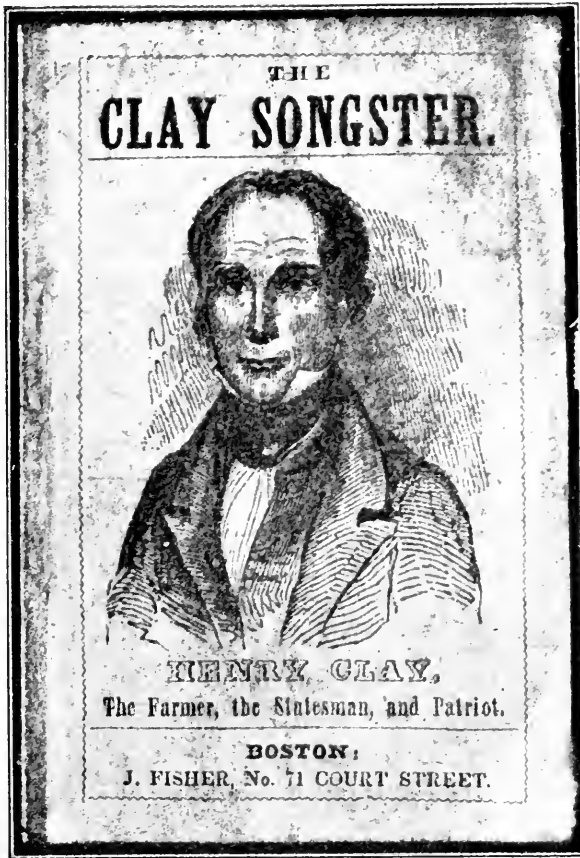

TITLE-PAGE OF "THE CLAY SONGSTER"

contest the boundary claims of Texas at the south; and the Democratic programme coupled "the reoccupation of Oregon" with "the reannexation of Texas,"—a matter which very likely held at its heart a war with

England. Russia had seemed the rival claimant most to be feared in the Oregon country in 1823, when Mr. Monroe, looking towards that quarter as well as towards the south, uttered his significant warning to the European powers against any aggression, whether in search of territory or of sovereignty, in the Americas; but Russia had agreed with England and the United States, in 1824 and 1825, to make no claim south of $54^{\circ} 40'$ north latitude; and England and the United States, waiving for the time their own rival pretensions, had maintained since that settlement an informal joint occupation of the country. Latitude 42° had been fixed, by the treaty of 1819 between the United States and Spain, as the northern limit of the Spanish possessions upon the Pacific. From the Lake of Woods to the doubtful Oregon country the northern boundary of the United States followed the forty-ninth parallel of north latitude.

All things might have stood as they were had that distant coast remained unused, unpeopled. But settlers and fur traders were moving there, as everywhere upon the tempting continent. English trading companies attempted to exercise exclusive rights there, the whole region through; set up their trading posts north and south upon the rivers; and kept American traders out. But not American settlers. Squatters came in, indifferent what title they held if only they had that of actual possession. Organized bands of settlers followed upon the heels of isolated squatters and single families, and little settlements began to be clustered here and there upon the rivers. The government at Washington refused to give them any grants for their lands, remembering its covenant of joint occupation with England; but the English could not exclude or oust them;

THE EXTENSION OF SLAVERY

and men and families who came to stay and make homes for themselves began presently to seem much more like actual owners of the disputed country than mere traders could or the agents of fur companies. Doubtful boundaries at the Pacific were fast becoming a distinct menace to peace. There were men in Congress, too, like Mr. Benton, who sought upon every opportunity to take the aggressive and force the government to a final settlement with Great Britain.

Disputes with England seemed to dog the steps of almost every Administration. It was but three years since Mr. Webster and Lord Ashburton had settled the difficult matter of the northern boundary of Maine by running a compromise line between Canadian and American territory upon the Atlantic. The air of politics, moreover, had never been quite still enough in America for dispassionate settlements by treaty. A veritable storm of outspoken opinion beat about every matter of controversy with foreign countries, if once it happened to catch the ear of the heady democracy which presidents and cabinets had it as their difficult task to lead. And that democracy was more confident, more wilful, more headstrong now, since General Jackson had shown it its way to supremacy, than it had ever been before. Presidents were no longer likely to attempt to withstand it as General Washington had withstood it in the day of its outcry against Mr. Jay's treaty with England. Mr. Polk was a man of his party; the question of the occupation of Oregon had taken hold of the imagination and the passion of the country; the convention which had nominated him had demanded that nothing less than the whole of the disputed region be required of England, up to the very line of the Rus-

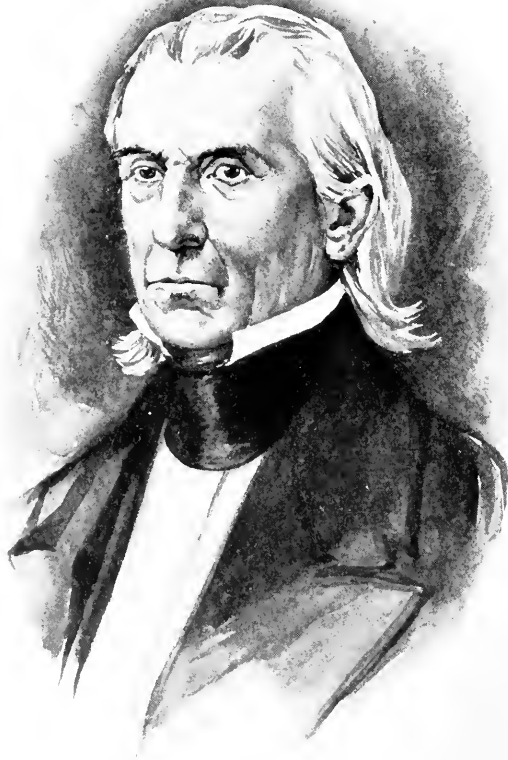

James K. Polk

JAMES K. POLK

THE EXTENSION OF SLAVERY

sian claim; the cry of the campaign had been "Fifty-four forty or fight." England, on her part, pushed her claim southward to the Columbia River, where her fur traders had set a station up. Only the cooling processes of actual negotiation cleared the matter and brought safer counsels in. Mr. Buchanan, the new Secretary of State, was not of the fibre to insist in the face of emphatic refusal of what he demanded; the English government looked with evident uneasiness upon the state of opinion in the United States; a comparison of views brought concessions on each side; and in 1846 the Senate consented to a treaty which continued the line of the forty-ninth degree of north latitude to the Georgian Straits as the definitive northern boundary of the Union.

The Texan boundaries were another matter. Here the government dealt with a rival and neighbor with whom no compromise was necessary. Texas claimed, not only everything north and west of her that had been Spain's or Mexico's all the way to latitude 42°, but also so much of the territory of her one-time partner State, Coahuila, as lay between the Nueces and the Rio Grande del Norte at the south; and Mr. Polk espoused and acted upon her claims at the south even before her formal admission into the Union was complete. He ordered General Zachary Taylor to occupy the western bank of the Nueces with a small force of United States troops, and during the summer of 1845 sent him reinforcements which raised his strength to nearly four thousand men. In December, 1845, Texas became in full form a State of the Union; and early in the following year the President ordered General Taylor to advance to the Rio Grande. His presence there

threatened the Mexican town of Matamoros, just beyond the river, and the Mexican commander at Matamoros demanded his withdrawal to the Nueces. General Taylor refused to withdraw. The Mexicans crossed the river, and on April 23d ambushed a small body of American dragoons. Two weeks later they attacked General Taylor in force and he repulsed them (Palo Alto, May 8, 1846). The next day Taylor in his turn attacked, and drove the Mexicans back across the river in disastrous rout. On the 18th General Taylor himself passed the Rio Grande and occupied Matamoros.

"Mexico," the President told Congress on the 11th of May, while yet he had had no news except that of the ambush of the 23d of April, "Mexico has passed the boundaries of the United States . . . and shed American blood upon American soil. War exists, and exists by the act of Mexico herself." He had not consulted Congress before he ordered General Taylor forward to the Rio Grande and brought this momentous matter to a head, though it had been in session when the order was issued. He had taken full responsibility for that upon himself. War indeed existed,—but by whose act Congress was no longer at liberty to inquire. There was nothing for it but to vote supplies and an army; and a formal declaration of war was resolved upon May 13, 1846, before news of the real fighting on the Rio Grande had reached the capital.

Until autumn all things stood as they were between the belligerents while an army was made ready; but late in August General Taylor moved again, and within a month, by severe and dogged fighting (September 21-23), took the strongly fortified town of Monterey, a full hundred and seventy miles to the west of



Zachary Taylor

ZACHARY TAYLOR

Matamoros on the highway to the Mexican capital. In November General Winfield Scott, the ranking officer of the federal service, was given chief command, and in January, 1847, General Taylor's force was reduced to a scant five thousand to recruit the immediate command of his superior, sent by sea to attack Vera Cruz. On the 22d and 23d of February Santa Anna attacked him, with four times his numbers, where he lay at defence on the broken plain of Buena Vista, thinking to crush him while he was weak; and was repulsed. The Americans were no longer raw militia, men and officers alike, as they had been in the extemporized armies of 1812. Though they were for the more part volunteers, their officers were professionals, and they were drilled and handled with a skill and thoroughness that made veterans of them with a single battle.

Their steadiness and prowess were put to full test with General Scott in the south. There they had not only to take Vera Cruz by set siege (March 9-29, 1847) in order to make good their landing, but had also to scale the huge escarpments of the vast table-land upon which the Mexican capital lay, two hundred miles away, more than seven thousand feet above the sea, and to make their way across the broken, hilly plains beyond, fighting everywhere as they went against an enemy who outnumbered them and was secure against surprise within safe inner lines of communication. And yet from the carrying of the pass at Cerro Gordo (April 18, 1847) to the storming of the high fortress of Chapultepec (September 13th) there was no pause or miscarriage in the steady process of their victories. The city of Mexico lay amidst guarding fortresses and was set about by morasses crossed only by narrow causeways.

THE EXTENSION OF SLAVERY

But the Americans moved everywhere with the business-like certainty and precision of men well handled, and



Winfield Scott

WINFIELD SCOTT

their volunteer ranks seemed less in need of officers than other armies did. Individual pluck and dash and resourceful daring showed, irresistible, in all that they did. They fought men as brave as themselves, a

subtle, spirited race, tenacious to the last of all that it could hold; they fought, also, against odds and moved everywhere against fortified places; but they won undaunted at every onset. By the 15th of September they were in complete and formal possession of the enemy's capital and Mexico was in their hands, within but a little more than six months of their landing.

Meanwhile the government at Washington had broadened the scope and meaning of the war beyond all expectation. During the summer of 1846 and the winter of 1846-1847 it had seized, not merely the disputed territory which Texas claimed, but also the whole country of the Pacific slope beyond, from Oregon to the Gila River, to which the United States could have no conceivable right except that of conquest. The thing was easily accomplished. A fleet under Commodores Sloat and Stockton and a few troops acting here and there under Colonel Kearney and Captain Frémont moved almost as they pleased; and a territory of six hundred thousand square miles was added to the United States.

The war, with all its inexcusable aggression and fine fighting, was brought to its formal close by a treaty, signed at Guadalupe Hidalgo on the 2d of February, 1848, by which Mexico recognized the Rio Grande as the southwestern boundary line of Texas and ceded New Mexico and California, of which the United States had taken possession by force of arms. For this territory, seized and ceded, the United States agreed to pay Mexico fifteen million dollars.

It had been evident from the first what the outcome of the war must be. When, in August, 1846, Congress

THE EXTENSION OF SLAVERY

had had under consideration an additional money vote of two millions, "for the settlement of the boundary question with Mexico," there had been no doubt in the mind of any candid or well informed man that the money was really to be spent for the acquisition of territory as opportunity offered. Members of Congress very well knew what question that opened again. Mr. David Wilmot, a Democratic member of the House from Pennsylvania, therefore, promptly offered as an amendment to the vote the *proviso* that neither slavery nor involuntary servitude should be permitted in any territory that might be acquired from Mexico. The amendment passed the House with the money vote, but miscarried in the Senate, with the money vote itself,



THE DEPARTURE OF THE PHILADELPHIA VOLUNTEERS FROM PHILADELPHIA.

From a humorous drawing by F. O. C. Darley.

because it provoked debate and there was not time enough at the fag-end of a session to push it past debate to its passage. It was necessary that the matter of the proviso should be settled. The Missouri compromise line ran only to the western boundary of the Louisiana purchase; the war brought accessions of territory as extensive, almost, as Louisiana itself; the question of the extension of slavery once more awaited debate and settlement. Here were vast provinces greater than the entire area of the original Union. Was slavery to be carried into them, and were slave States to be erected along the mountains and by the Pacific which should preserve the political balance of North and South in the Senate? The "Wilmot proviso" must be adopted or rejected; its question could not be put out of sight.

While the war lasted and the troublesome questions it bred were yet in abeyance, the Democrats made good the programme of domestic administration they had set themselves. By the elections of 1844 both houses of Congress had become Democratic, and party measures could be carried. In July, 1846, therefore, a new tariff Act was passed which brought protective duties down almost to a strict revenue basis, and considerably enlarged the free list. In August an Act was passed which once more established the Independent Treasury, substantially as Mr. Van Buren had planned it. The expenses of the war were met, so far as the revenues fell short, by large issues of interest-bearing treasury notes. The Democratic leaders were steadfast in their determination neither to use the banks nor to increase the tariff in order to assist the Treasury.

But their power came to an end with the first Congress

CHARGE OF THE "PALMETTOS" AT CHURUBUSCO



A HISTORY OF THE AMERICAN PEOPLE



MAIN STREET IN AUSTIN, TEXAS, ABOUT 1845

of Mr. Polk's administration. The congressional elections of the autumn of 1846 transformed the majority in the House from Democratic to Whig again. The Senate, more slow to change, remained Democratic. With the houses no longer agreed, party plans fell into confusion. Congress was once more disturbed by questions which lay deeper than politics and cut both parties athwart with the lines of faction. The question of slavery had returned again to plague it. The Democratic Senate wished to pass an appropriation bill "for the settlement of the boundary question" in which nothing should be said about the extension of slavery; the Whigs of the House insisted upon Mr. Wilmot's proviso. Oregon was drawn into the controversy. The Senate would agree to no bill organizing Oregon as a Territory which excluded slavery; the House would adopt no measure which did not exclude it. The treaty of peace and cession found the houses still unagreed. Not until August, 1848, could they agree even upon the organization of Oregon. Then the Senate yielded and the Territory was organized under a law which

THE EXTENSION OF SLAVERY

extended to her area the prohibitions of the Ordinance of 1787. But in the matter of California and New Mexico the dead-lock was unbroken. All measures failed, and the new territories were left with no law but such as they had got from Mexico.

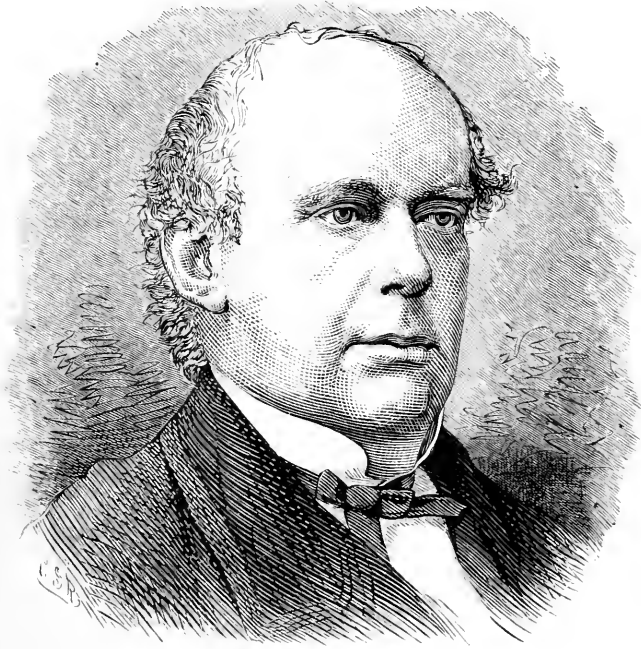

S. P. Chase

SALMON PORTLAND CHASE

Democratic politicians, indeed, put forward a political doctrine in the matter which, if accepted, would make it unnecessary for Congress to act at all upon the chief question at issue. The introduction or non-introduction of slavery into those territories, they said, was not a

thing to be determined beforehand or by federal authority: it must be determined by circumstances and by the free choice of the people who were to make their homes there. It ought to be their privilege to choose their own institutions and economy of life, and Congress ought not to attempt to dictate what their choice should be. They called this a principle of democracy, that every community should determine its own life; but it came too late to their lips to look like anything more than a counsel of timidity and inaction, a makeshift party doctrine of "squatter sovereignty"; and opinion was neither stayed nor satisfied by the compromise it offered.

That year of dead-lock between the houses was the year also of a presidential election; and no one who looked observantly upon the incidents of that year doubted what significant changes were setting in. The airs of opinion blew now out of this quarter and again out of that, but their shifting currents foretold, to those who could read the weather, the setting in of the trades, which should blow continuously and with increasing volume out of one quarter a long season through. Both Whigs and Democrats observed the signs of the times, and fell silent upon the main issue that was in every man's mind, awaiting steadier weather. The Democrats, turning from Mr. Polk, nominated Mr. Lewis Cass, of Michigan, for President, a man conspicuous among them for conservative temper and liberal ways of thought, and spoke in their declaration of principles only of old doctrines, deliberately excluding an avowal of the doctrine of non-interference with the extension of slavery. The Whigs, more cautious still, fell back again upon their tactics of 1840: nominated for President

THE EXTENSION OF SLAVERY

General Zachary Taylor, no politician but a frank soldier like General Harrison; for Vice President Mr. Millard Fillmore, of New York; and made no declaration of principles at all. But the issue was not obscured. A strong faction of Democrats in New York drew off from their party in open protest against the programme



Lewis Cass

LEWIS CASS

it did not avow, and in conjunction with men of their own mind out of four other States nominated Mr. Van Buren, who had stood from the first in frank opposition to the extension of slavery. Nor was that all. In August, at Buffalo, still another convention came together, composed of delegates out of eighteen States, to form an independent free soil party, pledged neither to interfere with slavery in the States, whose laws Con-

gress had no power to change, nor to permit its introduction into the Territories, whose laws Congress was empowered to make; and it also put Mr. Van Buren in nomination.

The Democratic split in New York cost Mr. Cass the election. The thirty-six votes of the State went to



T. W. Dorr.

THOMAS WILSON DORR

General Taylor; and thirty-six was General Taylor's majority in the electoral college. Mr. Van Buren received nearly three hundred thousand votes. The "Free Soilers" had drawn their strength rather from the Whigs than from the Democrats, it turned out, except in New York, and were to hold the balance of power in the next House, where neither Democrats nor Whigs could command a majority without them. Only the Senate remained Democratic. A "free soil"

campaign had cut party lines sharply athwart, and no man could safely forecast what was to come.

All things seemed touched with change. The country offered but a confused and troubled stage upon which to order parties or make and execute plans of action. The decade through new forces had seemed to gather head, and old forces to be checked and altered (1840-1850). Rhode Island had found herself obliged to

THE EXTENSION OF SLAVERY

enlarge her suffrage and make liberal changes in her old-fashioned constitution, kept unaltered since old colony days, in order to quiet actual rebellion, under one Thomas Dorr. The legislature of New York had been obliged to secure fee simple titles for the men who farmed the lands on the Hudson still leased, for a rent in kind, from the heirs of the Dutch patroons; because they flatly refused to pay the rents any longer, resisted the sheriff's



SAN FRANCISCO, CALIFORNIA, IN 1848

process with arms, and would pay for nothing but absolute title. Six thousand miles of railway were built while Mr. Tyler negotiated the annexation of Texas and Mr. Polk thrust Mexico to the wall. The population of the country increased from seventeen to twenty-three millions. Florida, Iowa, and Wisconsin, as well as Texas, were added to the roll of States. The electric telegraph, spreading with the railways, whose administration it so much eased and simplified, quickened also and gave sweep to the movements of trade and of opinion.

A great tide of immigration, moreover, began to pour in, such as the country had never seen before. Until 1842 there had never been so many as a hundred thousand immigrants in a single year; but in 1845 there were one hundred and fourteen thousand, and by 1849 there were two hundred and ninety-seven thousand coming in within a twelvemonth, the tide rising steadily from year to year. These were years of deep distress over sea. 1846 and 1847 were the years of the terrible famine in Ireland; 1848 saw European states shaken once again by revolution. Not only men out of Ireland, looking for a land where there was food, but men also out of the old monarchies of the continent, looking for a land where there was liberty,—men of wholly foreign speech and habit, seeking a free place for a new life, bent upon their own betterment, and thinking little of aught that did not touch their own fortunes,—came crowding endlessly in. They did not go into the South, where labor was not free, for they were laborers. They crowded, rather, into the cities at the north, or pushed on to the virgin West. Their coming, thousands upon thousands, their ceaseless movement into the West, their stir as of an invading host, subtly gave new impulse to the general movement and resettlement of the population, already afoot of its own accord: to the opening of new lands, the diversification of industry, the quick growth of a nation always making and to be made. Until now the country had been developed for the most part only by men out of the old homes of the first settlers and by natural increase of its own people. Now there was added this power of increase and subtle impulse of change from without. And the tide of men from over sea, once set running, did not ebb or recede. States-

THE EXTENSION OF SLAVERY

men found themselves obliged to accommodate affairs to a day of new forces, which escaped them and dominated all that they did.

Whether it came by immigration or by natural increase, growth of population meant the augmentation, not of sectional, but of national forces. The slave-

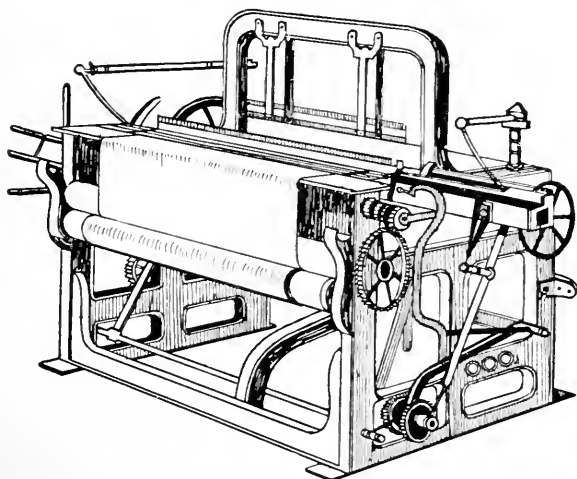

ENGLISH POWER LOOM FOR WEAVING COTTON, 1847

holding States, though their number included Missouri and Arkansas, which shared the growth of the frontier, showed, even with Texas added, an increase of but little more than two millions in the decade, while the rest of the country saw nearly four millions added to its strength. Industry, too, moved with as quick a pace as population, and invention bettered and facilitated its processes at every step. By 1846 a fully practicable sewing machine had been developed and patented. In 1847 the rotary printing press was invented. The power loom was still further varied and perfected. An

A HISTORY OF THE AMERICAN PEOPLE

age of machinery was pushing forward every process of production, every means of communication, everything that touched either thought or effort.

Though the southern politicians talked only of constitutional rights, and seemed to fight only for the extension of slavery, southern merchants held conventions to plan railways to the Pacific and debated measures for linking their trade with the expanding West. Their thoughts ran eagerly and with a certain enthusiasm upon the great future of the nation, in which they wished to take their part. Their plans were made upon the scale of the continent; they spoke in the spirit of the new age, and sought their right rôle in the general development. And yet there was in all that they said and urged an unmistakable note also of apprehension. They wished to take part, and yet began to fear that they could not. They spoke of the nation, and of their duty and their opportunity in it; but the nation of their thought was not a nation which could easily be united in joint efforts of business. It was a nation sectionalized and divided by social and economic contrasts too gross and obvious to be overlooked; a nation whose several regions showed interests diverse and separate, hardly to be reconciled. This they saw, some vaguely, some with painful clearness, and a deep uneasiness grew upon them more and more from year to year. The spirit and the power of the time were turned against them.

And the issues which made their place apart a fact, not of speculation but of certainty, were mightily hastened by every force afoot in the life of the country as it grew. It became evident almost at once that Congress could not avoid or even postpone its choice with

THE EXTENSION OF SLAVERY

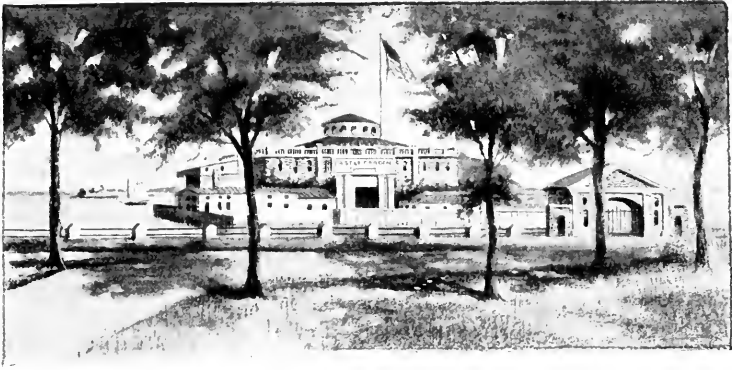

CASTLE GARDEN, NEW YORK, IN 1850

regard to slavery in the new territories seized from Mexico. The very month the treaty of Guadeloupe Hidalgo was signed (February, 1848) rich deposits of gold were discovered in California; and before the politicians at Washington were ready to organize the region as a Territory it had filled with an aggressive population which was making ready to demand its admission into the Union as a State. Before the census of 1850 was taken eighty thousand settlers had made their way thither, eager for treasure. Some had struggled across the interminable plains and over the mighty ridges of the Rockies; some had taken ship and gone the long way round about Cape Horn; some had crossed the isthmus of Central America and made their way in such craft as offered up the Pacific coast. The plains were ere long strewn with the bleaching bones of men and beasts, the coasts with frail craft cast away upon the incautious, eager voyage; but the quest did not cease or slacken. Thousands reached the faraway goal, found the golden fleece, and set themselves to build a

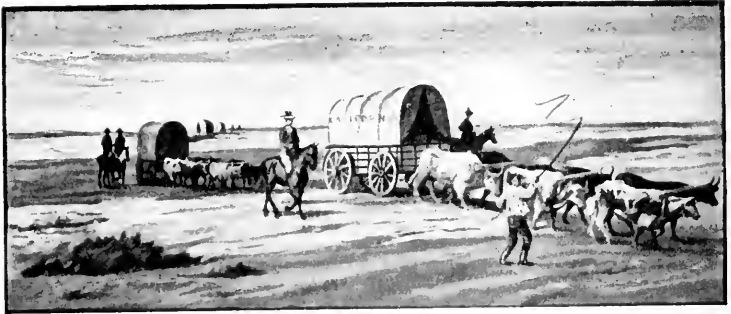

EMIGRANT TRAIN CROSSING THE PLAINS

State. It was evident enough that, with such things happening, Congress could not put action off.

The new President, too, forced the matter most uncomfortably. General Taylor had no sooner become President than he acted upon the situation in the West with a soldier's practical, businesslike candor and directness. He advised the settlers in California and New Mexico to frame state constitutions and apply at once for admission to the Union with institutions of their own choosing; and the Californians acted upon his advice so promptly that by the time Congress met they had erected a complete government, and he had ordered General Riley, the provisional military governor of the territory, to withdraw. When the houses assembled the frank soldier President advised them to admit the new State at once, and to postpone action with regard to New Mexico until it also should have completed its preparations for admission, then in progress.

But the thing was not to be so easily and simply handled. A deep excitement had spread through the

THE EXTENSION OF SLAVERY

country that eventful year. Again it had come to seem as if the future of the Union hung upon this issue. Very significant things had been said and threatened, which it was not easy to forget or dismiss. So long ago as 1843 John Quincy Adams, who thirty-five years before had left the Federalists because they talked of dissolving the Union, had joined with other Whigs in declaring that the addition of Texas to the South would bring about and justify disunion. Mr. Garrison, the leader of the abolitionists, had proposed in 1845 that Massachusetts should lead in a movement to withdraw from the Union, and had won very hearty applause for the suggestion from an anti-annexation convention. The masses of the people, it is true, did not heed these things; the counsels of sober statesmen were not seriously affected by them. But almost every northern State demanded, through its legislature, the adoption of



A TYPICAL HOTEL IN THE MIDDLE MINES, CALIFORNIA, ABOUT 1850

the Wilmot proviso, and every southern State protested against it, in tones not to be mistaken. The southern men, to whose demands Mr. Calhoun gave the touch of final definiteness which only words of precision such as he used could give, now denied outright the power of the federal government to exclude slaves, the legitimate property of southern settlers, from the Territories of the United States, and asserted the right of the people of the Territories "to act as they pleased upon the subject of the status of the negro race amongst them, as upon other subjects of internal policy, when they came to form their constitutions." The air was full of disquieting rumors as to what the southerners meant to do should Congress set that principle aside: how they meant to shut their ports against the North and turn all their arts and all their power towards building up an alliance, at once political and economic, with the West: how in the last resort they meant to secede from the Union altogether.

It was not an air in which action was easy to be determined upon. Even compromise seemed for a long time impossible. Mr. Clay, with the dignity of old age upon him, once more came forward as mediator, with counsels of accommodation for which he plead, not in his old tones of commanding leadership, but in new tones almost of supplication which it was very moving to hear. Mr. Webster ceased to speak of the constitution as an instrument of authority; spoke of it, rather, as a thing to be maintained by seeking ways of peace and compromise. But not until many anxious months had gone by, full of bitter, estranging debate, within the houses and without, could terms of agreement be hit upon. It was agreed at last, in the closing

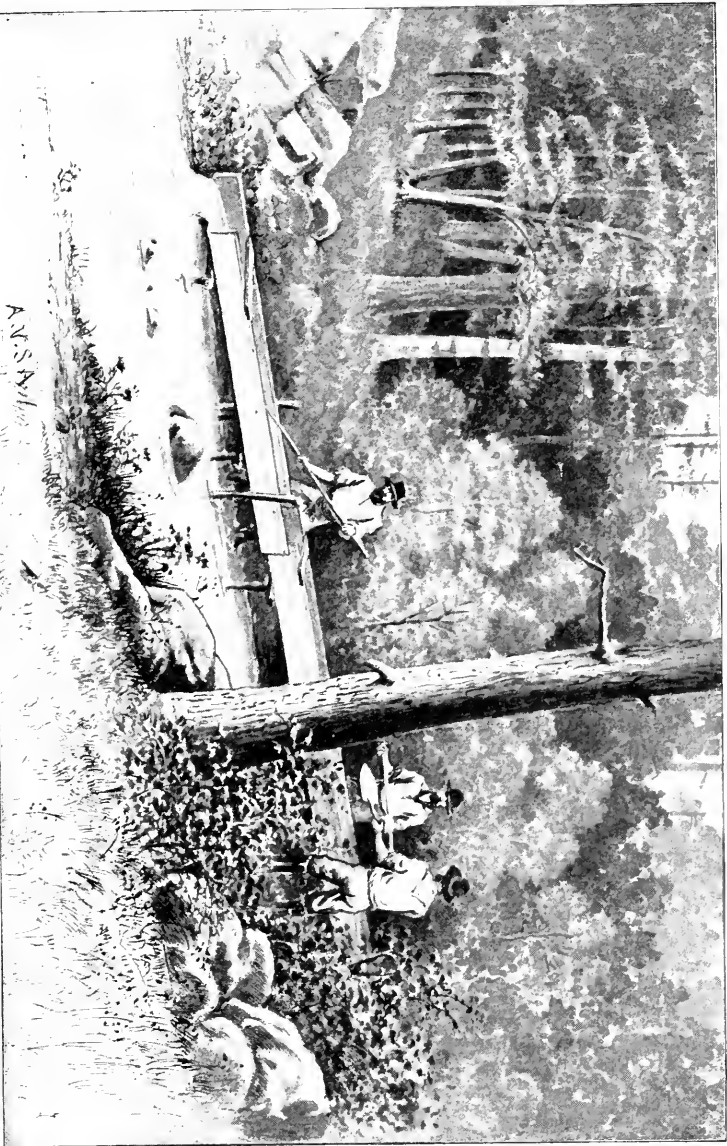

SLUICE WASHING FOR GOLD IN THE MIDDLE MINES, CALIFORNIA, ABOUT 1850

months of 1850, that California should be admitted to the Union as a free State, with the constitution she had herself formed; that the rest of the Mexican cession should be left open to slavery, should events and the movement of population out of the South establish it there; that the slave trade should be abolished in the District of Columbia; and that a stringent fugitive slave law should provide the southerners with effective legal means of recovering runaway slaves. Such was the bundle of measures that had to be got together to quiet all parties.

Meanwhile Mr. Calhoun was dead (March 31, 1850), while compromise yet hung doubtful,—and the President himself (July 9, 1850), of a sudden fever; and Mr. Fillmore was President, a man more amenable to the control of the leaders of Congress and of his party than the sturdy soldier had been whom he succeeded. The face of affairs had changed again with the settlement of the principles of compromise.

It meant more than the mere passing away of a notable figure that Mr. Calhoun was dead at such a juncture,—a tall, spare old man, the lines of whose striking face and haunting, deep-set eyes marked him as the very embodiment of a single stern and watchful purpose, an ascetic knight challenger set down in lonely guard to keep an ancient shrine of doctrine. Eight years before he had told his friends upon what single principle he had acted since 1825, and must ever act so long as he remained upon the field of action. He had opposed Mr. Adams and Mr. Clay, had first supported General Jackson and then turned from him, had acted with the Whigs against Mr. Van Buren and with Mr. Tyler against the Whigs always with this one hope and pur-

THE EXTENSION OF SLAVERY

pose, "to restore the old state rights Republican doctrines of '98; under the solemn belief that on their restoration the existence of our free popular institutions depended." He came of the hard-willed, indomitable stuff of the north of Ireland, and showed in all his strenu-



OLD SPANISH FORT AT MONTEREY, CALIFORNIA, IN 1848

ous course "the definite mind, the inflexible purpose, the reserved, self-restrained, somewhat ungenial temper of the Ulsterman." When he went off the stage politics seemed bereft of some force as of private and personal conviction, and left to the guidance of men who looked for their opportunity, not for their day of justification.

Our leading *general authorities* are still George Tucker, volume IV., Bryant and Gay, volume IV., James Schouler, volumes IV.

A HISTORY OF THE AMERICAN PEOPLE

and V., and H. von Holst, volumes II.-VI. Here we begin to have as guide Mr. James Ford Rhodes's *History of the United States from the Compromise of 1850*, volumes I. and II. We turn also, as before, to Carl Schurz's *Henry Clay* and Theodore Roosevelt's *Thomas H. Benton* in the *American Statesmen Series*; Calvin Colton's *Life and Speeches of Henry Clay*; George Ticknor Curtis's *Life of Daniel Webster* and *Life of James Buchanan*; Alexander Johnston's *History of American Politics*; Edward Stanwood's *History of the Presidency*; and A. W. Young's *American Statesman*.

The list of *special authorities* on particular topics or individual aspects of the history of the time is very long. The following may represent the whole. J. N. Larned's *History for Ready Reference*, which, under the title *United States* and under various special titles connected with the history of the country, contains copious and admirably selected extracts from the best writers; Lalor's *Cyclopaedia of Political Science, Political Economy, and United States History*; J. McK. Ormsby's *History of the Whig Party*; Henry A. Wise's *Seven Decades of the Union*; Alexander H. Stephens's *Constitutional View of the War between the States*; R. S. Ripley's *War With Mexico*; William Jay's *The Mexican War*; A. M. Williams's *Sam Houston and the War of Independence in Texas*; C. E. Lester's *Houston and His Republic*; R. D. Hunt's *Genesis of California's First Constitution* in the thirteenth volume of the *Johns Hopkins University Studies in Historical and Political Science*; D. King's *Thomas W. Dorr*, a Life of the leader of the rebellion in Rhode Island; E. R. Potter's *Considerations on Questions on Rhode Island*; E. P. Cheyney's *Anti-Rent Agitation in New York*; James Russell Soley's *Wars of the United States*, James B. Angell's *Diplomacy of the United States*, and Winsor and Channing's *Territorial Acquisitions and Divisions* in the seventh volume of Winsor's *Narrative and Critical History of America*; Albert Gallatin's *Right of the United States of America to the North Eastern Boundary*; William Barrows's *Oregon* in the *American Commonwealth Series*.

Among the most useful *biographies* are Lyon G. Tyler's *Letters and Times of the Tylers*; Josiah Quincy's *Life of John Quincy Adams*; W. W. Story's *Life of Joseph Story*; E. M. Shepard's *Martin Van Buren* in the *American Statesmen Series*; F. W. Seward's *Seward at Washington (1846-1861)*; E. L. Pierce's *Life of Charles Sumner*; Pleasant Stovall's *Life of Robert Toombs*; William P. Trent's *Life of W. G. Simms*; A. C. McLaughlin's *Lewis Cass* in the *American Statesmen Series*; Nicolay and Hay's *Life*

THE EXTENSION OF SLAVERY

of Lincoln; and Albert B. Hart's *Salmon P. Chase in the American Statesmen Series*.

Among the innumerable writings on slavery and the slavery question which now begin to be useful the following may be mentioned: Horace Greeley's *American Conflict and History of the Struggle for Slavery Extension*; W. Goodell's *Slavery and Anti-Slavery*; the first volume of J. W. Draper's *History of the Civil War*; E. A. Pollard's *Lost Cause*; Henry Wilson's *History of the Rise and Fall of the Slave Power*; Hodgson's *Cradle of the Confederacy*; George Lunt's *Origin of the Late War*; Marion G. McDougall's *Fugitive Slaves*; W. P. and F. J. Garrison's *Life of William Lloyd Garrison*; W. H. Siebert's *Underground Railroad*; Thomas R. R. Cobb's *Inquiry into the Law of Negro Slavery and Historical Sketch of Slavery*; J. C. Hurd's *Law of Freedom and Bondage*; Charles Francis Adams's *Life of Richard Henry Dana*; William Jay's *Miscellaneous Writings on Slavery*; Leveret W. Spring's *Kansas in the American Commonwealth Series*; Eli Thayer's *Kansas Crusade*.

Shosuke Sato's *Land Question*, in the fourth volume of the *Johns Hopkins University Studies in Historical and Political Science* treats of the system of public lands which underlay the westward expansion; Mr. F. W. Taussig's *Tariff History* sketches the political and economic aspects of tariff legislation; and Mr. David Kinley's *Independent Treasury System* narrates the various vicissitudes through which Mr. Van Buren's favorite plans passed before their final acceptance by Congress.

The chief sources are the *Register of Debates*; the *Congressional Documents*; the *Congressional Globe*; Thomas H. Benton's *Abridgment of the Debates of Congress*; *Niles's Register*, besides which the *National Era* (Washington), the *New York Times*, the *New York Tribune*, the *New York Evening Post* become available for contemporary matter; Thomas H. Benton's *Thirty Years' View*; Nathan Sargent's *Public Men and Events*; John Quincy Adams's *Memoirs*; Martin Van Buren's *Inquiry into the Origin and Growth of Political Parties in the United States*; Chevalier de Bacourt's *Souvenirs of a Diplomat*; Mrs. Chapman Coleman's *Life of John J. Crittenden*; Alexander Johnston's *Representative American Orations*; Hugh McCulloch's *Men and Measures of Half a Century*; George W. Curtis's *Correspondence of John Lathrop Motley*; Amos Kendall's *Autobiography*; Thurlow Weed's *Autobiography*; Herndon's *Life of Lincoln*; F. W. Seward's *Seward: An Autobiography*; Frederick Law Olmsted's *Cotton Kingdom*; Ben: Perley Poore's *Perley's Reminiscences*; W. Kennedy's *Rise and Prospects*

A HISTORY OF THE AMERICAN PEOPLE

of Texas; W. C. Crane's *Life and Select Literary Remains of Sam Houston*; Hinton R. Helper's *The Impending Crisis*; Susan D. Smedes's *Memorials of a Southern Planter*; Frances Anne Kemble's *Journal of a Residence on a Georgia Plantation*; the *Personal Memoirs of Ulysses S. Grant*; the case of *Luther vs. Borden*, touching the relation between the federal and state authorities in the matter of the rebellion in Rhode Island, reported in the seventh volume of Howard's Supreme Court Reports, p. 1; the cases of *Prigg vs. Pennsylvania*, 16 Peters's Reports, 539, and *Ableman vs. Booth*, 21 Howard, 506, touching upon the law with regard to fugitive slaves; and the *Kansas Historical Collections*.

CHAPTER IV

ARMED DIVISION

FOR a little while there was a calm upon the surface of affairs. Agitation fell quiet after the hard-won compromise, and the way seemed clear again for the sober counsels of peace, the everyday business and routine of politics and growth. But passion was none the less awake because it had fallen silent for a space. Thoughtful men could not forget what had been said in the debates which had accompanied the compromise, or how near those debates had seemed to bring them to a yawning gulf, where every danger gaped wide and obvious. "If you who represent the stronger portion," Mr. Calhoun had said, in words whose passion seemed all the deeper because of their slow and sober cadence, "if you who represent the stronger portion cannot agree to settle the great questions at issue on the broad principles of justice and duty, say so; and let the States we both represent agree to separate and depart in peace." And issue had been joined very sharply, for there had been men of a new temper on the other side who had spoken as frankly: free-soil Whigs and free-soil Democrats, men in their prime, but just come into Congress, bold and ready to push their views at any risk. Mr. Seward, the new Whig senator from New York, had proved himself in those memorable debates a veritable

philosophical radical, alike in opinion and in purpose. He had utterly repudiated all compromise, had denied the possibility of an equilibrium between the slave States and the free, and had declared the common domain of the country to be devoted to justice and liberty not only by the constitution but also by "a higher law than the constitution." He believed, he said, that slavery must give way "to the salutary instructions of economy and to the ripening influences of humanity"; that "all measures which fortified slavery or extended it tended to the consummation of violence,—all that checked its extension or abated its strength tended to its peaceful extirpation"; and that no makeshift or avoidance could make the issue either slow or doubtful. Mr. Calhoun had died with these things in his ears, face to face with the very tragedy he had striven with all the intensity of his deep nature to avert.

Men who gave little heed to debates and thought only of what they saw and knew presently found themselves stirred with a fresh and vivid passion of the mind as they witnessed or learned of the operations of the Fugitive Slave Law. The constitution itself commanded in explicit terms that fugitives from service, as well as fugitives from justice, who should escape from one State into another, should be delivered up and returned upon demand; and Congress, so long ago as 1793, had adopted a measure intended to secure obedience to the constitution in that matter. The behests of that statute, however, had been addressed, not to federal officers, but to the officials of the several States; magistrates and sheriffs in the northern States had shown greater and greater slackness in performing their duty under the statute, had, indeed, come more and more to

neglect it altogether, as opinion against slavery gathered head; and the Supreme Court of the United States had finally made utter dead letter of the law by deciding, in the case of *Prigg vs. Pennsylvania* (1842), that Congress could not in any case legally impose upon the officials of a State the duty of executing a law of the United States. The new law, therefore, which went with the compromise measures of 1850, provided in very imperative and rigorous fashion for the direct action of the federal authorities. The whole machinery of federal courts, commissioners, marshals, and deputies was put at the service of slave owners for the recovery of their runaway slaves; their simple affidavit was made sufficient proof of their right of ownership and recovery and of the identity of the negro claimed; federal marshals were made personally responsible for the successful execution of the writs of seizure and rendition; every private citizen summoned to assist was obliged to obey under heavy penalties; no doubt or difficulty or delay was anywhere permitted to be interposed if a master but made formal claim under oath.

The execution of the law, vigorously pushed by the southerners, — pushed even against one-time slaves long settled at the North but safe until now against apprehension; evaded, protested against, even resisted with riot and force of arms in the North, bred irritation and excitement which no art of the politician could check, no counsel of prudence divert. It brought open contest of opinion wherever executed, and every question which compromise and makeshift had sought to quiet and put by burned with a new and fiercer flame. Opinion and action were not to be controlled now as they had been in the early years of the republic, when

men took their cue from their leaders. . The broad extension of the suffrage had put the fortunes of all parties and policies in the hands of a thorough-going democracy. The free, inquisitive judgments of common men determined now what the method of affairs should be. New voters were added to the rolls, it might be ten or fifteen thousand by the year, as the population grew unchecked the seasons through. Public prints multiplied, and spread news and opinion in ways incalculable by politicians, upon a scale which no man could reckon. Close upon two thousand miles were added every year to the railways of the country, and telegraph lines in the same measure. There was no longer any checking or anticipating the sweep of impulse and opinion among a people more and more knit together by intercourse, interest, and acquaintance. New men, a new generation, again crowded forward; parties could not dictate what they should think; parties were indeed themselves to be transformed and mastered, rather, by the new forces now free of the field.

For two sad years Mr. Webster and Mr. Clay sought to keep the nation in hand, chiding every show of uneasiness or agitation under the compromise they had labored to effect; speaking of the measures of 1850 as the indispensable props of the constitution and of the Union itself; making all sober counsels of peace ring eloquent in every perfect phrase of conciliation and persuasion their genius could coin or their striking utterance and presence enforce. But quiet would not come at their bidding. Mr. Webster had lost his hold upon his own people. They had deemed his advocacy of the compromises a base and cowardly retreat from the high place of doctrine and of statesmanship he had

THE
ADDRESS AND PROCEEDINGS
OF THE
FRIENDS OF DANIEL WEBSTER,

ASSEMBLED IN FANEUIL HALL,

On Wednesday, September 13th, 1852,

MASS CONVENTION.

BOSTON:
JAMES FRENCH, 79 WASHINGTON STREET,
1852.

held so gallantly against Mr. Hayne, and now thought his defence of them but aggravation of his apostasy. Mr. Clay seemed already of another generation dead and gone. The new forces afield were not for his handling. Both men died with the infinite uneasiness of that last failure heavy upon them, Mr. Clay in June, Mr. Webster in October, 1852, fearing that they saw and knew what was to follow. The stage was clearing for another scene.

It was, indeed, difficult until these older figures were withdrawn to realize how radically the scene had changed, how singularly confused and altered the field of politics had become. Mr. Clay, Mr. Calhoun, and Mr. Webster, the notable men who had now made their sad exit, had come into affairs forty years ago, upon the eve of the second war with England. In their lifetime the very character of the government had changed. In the days when they had entered Congress, themselves men of a new generation, the country lived under a sort of parliamentary system. Congress looked to the Executive for guidance. The President's cabinet was made up of the recognized leaders of the dominant party. The succession to the presidency was determined by congressional caucus, and the Secretaryship of State was looked upon as the post of succession to the headship of the government. Parties were organized under men who got their authority from training and from close association with ruling groups of influential statesmen whose primacy in affairs no one dreamed of disputing. Massachusetts had her ruling coterie of authoritative leaders no less than Virginia. Her professional classes, her lawyers and ministers for the most part, determined her action in politics, — university

men, most of them, who yielded precedence to training, to experience, to age, to learning as of course, and put young men by to await their turn. Among them, as among the Virginians, certain families enjoyed a prescriptive pre-eminence. Any Englishman might have found the air and the method of action in that school of affairs of the familiar kind of all tradition amongst English speaking peoples.

The connection between Congress and the Executive was, it is true, private, not open or upon the floor of the houses. The President's official advisers did not appear in debate or take their places upon the floor as parliamentary leaders. The houses had by explicit vote declined to hear them there. Neither did they resign, as the King's ministers did, when the measures they suggested were defeated in a legislative vote. Their advice was given in private conference; they had no recognized responsibility for party legislation; they suffered no personal defeats and enjoyed no personal triumphs in Congress. But their influence was direct and powerful; and the government, for all its theoretical separation of parts, went forward as if of a single piece whenever the houses were of the President's party.

It had stood so until John Quincy Adams became President, with no party at his back, the representative of a group, not of a national majority. Already, in Mr. Monroe's day, the "era of good feeling," in which party lines were fading out and the discipline of parties was relaxed, Congress had got ready, with new standing committees, to act independently and on its own initiative. When Mr. Adams came in it took leave to criticise and resist rather than follow him; and after Mr. Adams came the democratic upheaval which made a

return to the older principles and methods of action forever impossible. It was noteworthy that there had fallen, with that change, a blight of final discredit upon the congressional caucuses which had for so long assumed to nominate the Presidents. Scattered state legislatures had made nominations of their own at the very dawn of General Jackson's day; conventions, called together by no party, by no group of political leaders even, but representing, it appeared, only some special class of citizens or some single locality, had volunteered also their advocacy of this man or that for the presidency. The political intimacy between Congress and the Executive having been lost, Congress lost also its initiative in choosing the nominal leader of the nation. That privilege passed to men such as those who had so shrewdly and so successfully set the currents of opinion running for General Jackson: private managers who knew how to use the machinery of newspaper comment, of busy personal correspondence, and of local organization to make opinion and control elections.

The process of change was a little obscured while General Jackson was President. No man had ever dominated the politics of the country with a more complete or unmistakable mastery. Congress did his bidding as willingly and as promptly as it had done the bidding of Washington or Jefferson. Few men stopped then to note the fact that he purposed nothing constructive, that his work was negative, reactionary, directed towards the "simplification" of the government and the tearing down of what the Federalists had built up. Neither did it appear at once what it meant that the President was making the patronage of office, not the action of Congress, the real instrument of his

power. He gave office to men who kept the discipline of parties at the elections, to local political managers, to the editors of serviceable newspapers, to those who watched and sought to govern the movements of popular opinion.

When he was gone it began to appear what the whole change was which had been brought to pass. It had become the habit of all parties alike to make their nominations for office in organized party conventions, and to look to the make-up of the conventions through the local managers who expected to profit by their success. The convention which nominated a President formulated also the programme of its party. Its declarations of principle bound the President whom it nominated, not only; they bound also the representatives of the party in Congress. And yet the convention was not elected for any kind of responsible service. Its members were not men picked out to frame legislation and test it by the processes of debate, or for any of the slow deliberations which make sound policy. They met to act without debate. They sat only for a day or two; got no real acquaintance with each other's principles or motives; acted hastily and under excitement. What was of more consequence still, they were chosen by the management and nomination of unknown men, the self-constituted party overseers of the several localities from which they came; men whom native shrewdness, or watchful, time-serving sagacity had made masters of the arts of nomination and election: small office holders, busy talkers, the editors of rural newspapers, the ruling spirits of local political clubs.

Here was a wholesale decentralization of politics. Opinion began to be made by a sort of incalculable

plébiscite. Party leaders found themselves, not giving suggestions, but taking them from the general drift. Congress presently showed itself apt rather to register the impressions which came to it, it hardly knew how, from the innumerable minor politicians of its dominant party than to originate measures and policies of its own. Party action yielded, too, to new forces of disintegration: for this new machinery of initiative facilitated division as well as organization. If old parties could be ruled by conventions, new parties could be created by them. It presently became a familiar thing to learn of the existence of a new party by learning of the assembling of a new convention which had put forth a new platform, and nominated a new candidate for the presidency. Every year set for a presidential election was now apt to yield some such significant symptom of shifting opinion, to show some new party formed or some recent party grown strong and aggressive. At any time the agitation of new questions or the alteration of old might produce a familiar fruitage of conventions. Men of independent initiative might at almost any time of excitement get their separate following, improvise their separate organization, and confuse the field of action by the introduction of what claimed and tried to be a new party.

When, in 1840, the Whigs put Mr. Van Buren from office it looked for a brief space as if the older traditions of the government were to be revived, as if Congress and the Executive were once more to draw together under the leadership of men both in the President's cabinet and on the floor of the houses. But General Harrison's death made that once more impossible. Mr. Tyler pleased the Democrats as little as he pleased

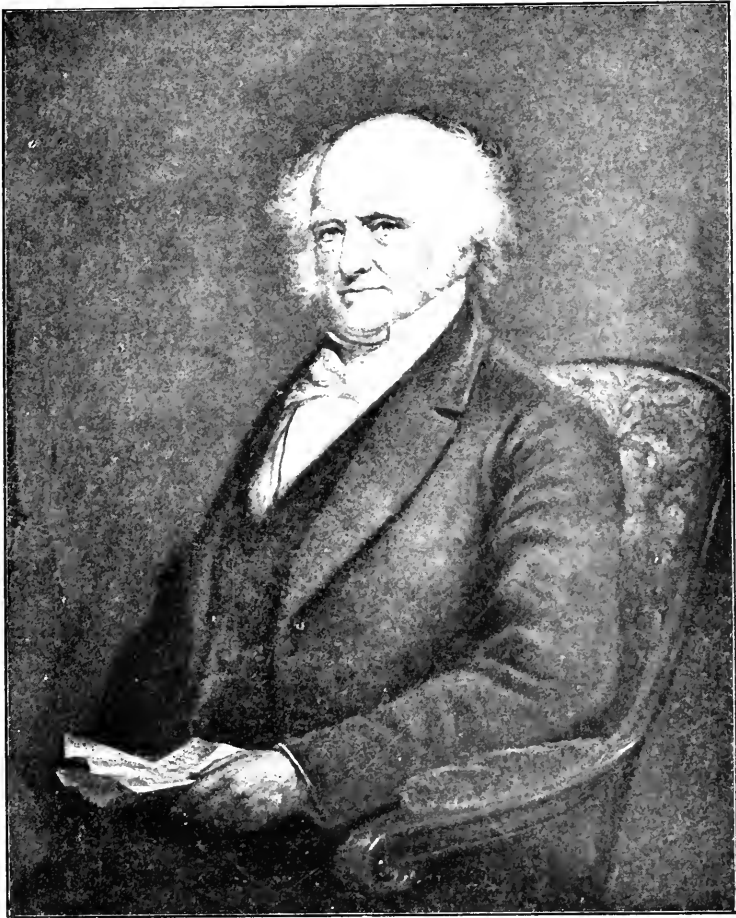

Martin Van Buren

MARTIN VAN BUREN

the Whigs; and the two branches of the government drifted further apart than ever. Once again, in 1848, the Whigs won; and some of their chief men became the President's advisers, Mr. Webster among them, as at the outset of General Harrison's term. But there was only a faint flicker of the revival of tradition in that. It was too late to go back to the old ways of administration.

In all ordinary seasons, while the old parties kept their discipline and their prestige, mere flurries of independent action might cause politicians little or no uneasiness; but in seasons when men's minds were likely to take a touch of passion from the questions of the hour there was no telling what a new convention might portend. This new and facile machinery of agitation was as suitable for acts of principle as for schemes of manipulation. Mr. Clay and Mr. Webster looked from their death-beds upon a strangely altered scene. Passions were astir which might shake parties to pieces at any moment. The rule of parliamentary leaders belonged to an age gone by. Compromises arranged in Congress were conclusive of nothing should the thought of the nation once shake the foundations upon which they rested.

Even yet, however, the signs of change were partially obscured. A presidential election fell in that year, and parties seemed steadier than before in their choice of candidates and issues. A convention of Free Soilers met again (August 11, 1852), as four years before, and again spoke their uncompromising programme very plainly: "No more slave States, no more slave Territories, no nationalized slavery, no national legislation for the extradition of slaves"; but their following

proved less numerous than it had been in 1848. The Whig ranks were not a little thinned and disordered by the uneasiness and defections of a time of dread and doubt; and when the party convention, in June, put forward General Winfield Scott, a third popular soldier, as its candidate, and declared itself entirely satisfied with the compromise of 1850, many a man of conviction and initiative turned away from it, as from a party which had lost courage and statesmanship. But the Democrats acted with their old-time confidence and unanimity, and won, upon a declaration of views which committed them not only to the maintenance of the compromise but also to an unqualified adoption of "the principles laid down in the Kentucky and Virginia Resolutions of 1798 and 1799 and the Report of Mr. Madison to the Virginia legislature in 1799,"—principles which they declared themselves resolved to carry out "in their obvious meaning and import." Such a programme would have satisfied even Mr. Calhoun. They had not been able to nominate any one of their recognized leaders for the presidency; for their convention had acted, as always, under a rule which prescribed two-thirds as the majority necessary for a nomination, and neither Mr. Cass nor Mr. Buchanan nor Mr. Douglas had been able to command so large a support; but their choice had fallen upon Mr. Franklin Pierce, of New Hampshire, whose handsome person and prepossessing manners, whose record as a gallant commander of volunteers in the Mexican war and an honorable, even if undistinguished, representative of his State in Congress, they could look upon with some degree of complacency.

They supported him with every appearance of hearti-



Franklin Pierce

FRANKLIN PIERCE

ARMED DIVISION

ness, and carried every State for him except Vermont, Massachusetts, Tennessee, and Kentucky, securing two hundred and fifty-four electoral votes as against General Scott's forty-two. The popular vote for Mr. Pierce exceeded that for his two opponents combined by less than sixty thousand out of a total vote of more than three millions; but it was noteworthy how widespread and general the success of the Democrats had been; how completely they had closed the breaches made in their ranks four years before. Apparently they controlled both the country and the government.

Not that the country was quiet or at ease. Opinion shifted feverishly, incalculably, as if moved and driven by some unquiet spirit which it sought by some means to lay or escape. The Democrats had won in the elections because the Whigs had suffered hopeless division of opinion and had already in fact fallen asunder upon the question of slavery. The Democrats alone, with their chief strength at the South, kept their organization and their power of united action. Men who could not act with them now looked for a party, and yet feared to form one which should bring the sections face to face and fight the slavery question out. And yet they could not thrust that question into the background or forget it. Territories were always making and to be made. That unresting host forever moving upon the western plains and rivers must presently be told what Congress meant itself to do, or let them do, with regard to the use and ownership of slaves. Root-and-branch opponents of slavery were very actively and aggressively making opinion against it without too tenderly considering either the politicians who wanted to think of something else or the merchants and manufacturers

who dreaded to see peace and trade disturbed. During the very summer of the presidential campaign (1852) Mrs. Harriet Beecher Stowe had published *Uncle Tom's Cabin*, a stirring story of the life of a southern slave, and the book had done more, as it were upon the instant, to bring opinion to a quick awakening than any score of political pamphlets could have done. Its moving scenes, its pathos, its humor touched with tears, its air as of the real tragedy and pity and hope of life acted upon sensitive minds with a power they could not resist; and bred everywhere a slow passion of philanthropic reform which politicians had presently to look to. It was not a true picture of slavery. It was a romance sprung out of the sympathetic imagination of a refined and sensitive woman, whose pity kindled at every thought of the black bondsmen at the South. It told, unquestionably, of what slavery might produce, of what no doubt it did produce upon occasion, of the terrible possibilities and in some part the terrible realities of the master's power and the slave's subjection; but no one could read in it the real life of the negro or take from it any just conception of the system of slavery as actually carried by the vast majority of southern masters. The people who read it, nevertheless, knew no other picture than this, and were filled with pity and deep horror. Politicians had presently good reason to know what this new engine of agitation meant.

Still, those who chose looked another way and refused to be drawn into this matter. All who felt the older motives of politics strong within them and dreaded upheaval declined to touch the critical business. Men of uncompromising free soil convictions, on the other hand, whether Whigs or Democrats hitherto, slowly

UNCLE TOM'S CABIN;
OR,
LIFE AMONG THE LOWLY.

BY
HARRIET BEECHER STOWE.



VOL. I.

BOSTON:
JOHN P. JEWETT & COMPANY.
CLEVELAND, OHIO:
JEWETT, PROCTOR & WORTHINGTON.
1852.

TITLE-PAGE OF "UNCLE TOM'S CABIN"

drew off from the regular parties and formed outspoken plans of opposition, frankly making slavery their issue. But the majority of Democrats adhered steadily to their party, and the majority of Whigs dreaded the threatened conflict and doubted its outcome; sought any diversion rather than make this ugly issue the acknowledged and only line between parties. Many persuaded themselves that the most immediate peril of the country came from the sudden and enormous influx of foreigners which recent years had witnessed. The great flood poured in at the eastern ports and left its most unwholesome deposits there; sent on the best things it carried to the western farms and the open regions of the interior. It brought men whom revolution had thrust out of the old world, men who wanted power and were apt at intrigue, restless men, many of whom were outcasts, some of whom were desperadoes. Now at last there came even men out of the alien Orient to the lands by the Pacific. Here was cause enough for uneasiness. If men looked for an issue, here was one: the preservation of the country's institutions in the face of such inroads, the maintenance of a safe ascendancy in affairs for those born and bred to the politics and manners of America.

So long ago as 1844 matters had shaped themselves very sharply on this issue in New York and Philadelphia, the cities most threatened by the unwelcome invasion. Now feeling began to gather head upon a greater scale. A secret "Order of United Americans" was formed, whose motto was, "Americans must rule America"; and to this order many uneasy men were drawn to whom its principles were a pleasant relief from the stress of the slavery question; as well as all those

PRICE, TWENTY-FIVE CENTS.

THE
BOSTON SLAVE RIOT,
AND
TRIAL
OF
Anthony Burns,



REPORT OF THE FANFILL HALL MEETING, THE MURDER OF
BACHELIER, THE OPORT PAPER'S TRIAL, ON FOR THE DAY
SPEECHES OF COUNSELL ON BOTH SIDES, CORRECTED
BY THEMSELVES, VERBATIM REPORT OF JUDGE
FOUNDS' DECISION, AND A DETAILLED AC-
COUNT OF THE EMBARRASSMENT.

BOSTON:
LESLIE AND COMPANY
1854.

Printed and Published by W. L. G. & Co., No. 10, South Street, Boston.

COVER OF PAMPHLET ON THE BOSTON SLAVE RIOT

who dreaded or hated the foreigner or feared to see the Roman Catholic church of the Continent brought into power in America along with its thousands of adherents crowding in. Only those who were advanced to the highest ranks of the Order's hierarchy were inducted into its full mysteries; the rest professed entire ignorance of its secrets, often of its very existence, and were dubbed "Know Nothings" for their reticence.

In some quarters the rising philanthropic feeling of the time found expression in a very pronounced renewal of the temperance movement. The year 1851 witnessed the adoption in Maine of a stringent law which absolutely forbade the manufacture or sale of intoxicating liquors within the State; and many earnest people elsewhere hailed the novel statute as a hopeful promise of social betterment, an example to be emulated. But such things did not yet draw to them the deeper currents of the country's thought. To every man who looked thoughtfully upon the face of affairs the slavery question obviously stalked obtrusive at the front of all policy, despite compromises and evasions. It was the southerners, besides, who seemed always to force the fighting. Whether the question were the reception of a petition against the continuance of the slave trade in the District of Columbia or the acquisition and government of new territory or the admission of a state into the Union, they let no opportunity go by to make known their claims and rights under the constitutional arrangement. They saw with the keen insight of those who lose that the game of growth and extending power went steadily against them. They valued the Union as dearly as the men of the North, were bent upon its preservation as earnestly and honorably as their compatriots of any

ARMED DIVISION

section; but they were convinced, with good reason, that its preservation depended upon the maintenance of an equilibrium between the sections, and they were determined, with Mr. Calhoun, to make their fight now, while yet there was a chance to win. They waged it, accordingly, like men suspiciously on guard in the face of a subtle enemy, and upon occasion deeply irritated even their friends with their noisy and ceaseless protests, driving their enemies to a like watchfulness and aggression.

Upon the assembling of the first Congress of Mr. Pierce's administration fortune seemed for the nonce to smile upon them. They were accorded a victory sudden, unlooked for, radical, costly, which instantly put a new face upon affairs,—nothing less than the repeal of the Missouri compromise and the opening of every Territory that remained to slavery. No one but Mr. Douglas would have had the audacity to attempt so revolutionary a measure; but Mr. Douglas had the hardihood of the frontier and the initiative of a natural leader of men. Stephen A. Douglas was one of the senators from Illinois. He had gone west out of Vermont when a mere lad, had served a rough apprenticeship in the new country, had made himself a lawyer and a judge of the supreme court of the young State before he was thirty, had entered the House of Representatives in 1843, at thirty, and the Senate in 1847, at thirty-four, and was now in his prime, showing at their full vigor the extraordinary qualities which had won him his quick advancement. His short and massive figure, his square head, steady, deep-set eyes, and mouth cut straight and firm, in lines unsensitive and full of will, bespoke him the man he was: a man

to make and have his way, fearless, sincere, compact of force; commanding others, but not to be commanded himself; coarse-fibred, daring, ready witted, loud, and yet prepossessing withal, winning friends and receiving homage.

He watched as keenly as Mr. Benton did the progress of the West, and had become, by natural selection, chairman of the Senate's Committee on Territories. Across the broad "Platte country," he knew, which stretched all the way from Iowa and Missouri to the foot of the great Rockies, lay the chief highway into the far West. He feared, in common with other western men, that it might be closed against travel by treaties made at Washington with the Indian tribes whose hunting fields lay upon it, and all the movement of life and settlement in the West embarrassed by the erection of an Indian reservation athwart the great route; and ever since he came into Congress, ten years ago, he had been pressing the question of its settlement and organization as a Territory instead. In the session of 1853-54 he had his will in the matter at last, and brought on political revolution besides. As chairman of the Senate Committee on Territories, he introduced, early in January, 1854, a bill which provided for the organization of the Platte country as the Territory of Nebraska; but, finding many features of the bill unacceptable to the Senate, presently withdrew it and substituted another (January 23d) which provided for the creation of two Territories, Kansas and Nebraska, the one lying immediately to the west of the once disputed ground of Missouri, the other lying to the north beyond Iowa, upon the great plains through which the Platte found its way to the Missouri. The first measure had provided

ARMED DIVISION

that the people of the new Territory should make their own choice in the matter of slavery; in the second measure the Missouri compromise was explicitly "declared inoperative and void," because "inconsistent with the principles of non-intervention by Congress with slavery in the States and Territories as recognized by the legislation of 1850." The healing work of two generations of statesmen was destroyed at a stroke. Mr. Douglas deemed such a course dictated by "a proper sense of patriotic duty," in order that the compromise measures of 1850 might be given their full effect, the right of Congress to interfere with the question of property in slaves clearly negatived, and the entire sovereignty of the people in their self-constituted groups, first as Territories and then as States, conspicuously set up, as the doctrine which seemed to him most likely to solve every practical difficulty. Mr. Pierce, the President, pronounced the bill a return to a "sound principle, which the compromise of 1820 infringed upon."

It was in fact matter of revolution. The southern members eagerly accepted what they had not asked for; northern men who were of the triumphant Democratic ranks blindly followed Mr. Douglas; and by the end of May the bill was law, spite of protests, spite of every sign of the profound and painful sensation it was to make, the country through. Mr. Seward and Mr. Chase were no longer alone in the Senate; Hamilton Fish, of New York, Solomon Foote, of Vermont, Benjamin Wade, of Ohio, Charles Sumner, of Massachusetts stood with them to contest the ground against slavery every foot, by every means of word or action. But they availed nothing against the confident majorities which Mr. Douglas led, and the thing was done.

A HISTORY OF THE AMERICAN PEOPLE

Strict party discipline was maintained in the houses, and Mr. Douglas was unmistakably the leader of the Democratic majority. He might almost be said to



William H. Seward.

WILLIAM H. SEWARD

be for the moment the leader of the government. Congress had learned very thoroughly how to do without the leadership or suggestions of the Executive; had organized itself very efficiently for action on its own

ARMED DIVISION

initiative. The House very readily yielded itself to the control of its Speaker, whom it was more and more coming to regard not only as its presiding officer but also as its political leader. Its committees were constituted by his appointment, and it more and more gave itself over to the guidance of its committees. Mr. Polk, when he was Speaker, had set the example of constituting each committee in such a way as to make it an instrument for carrying the purposes of the leaders of the majority into effect in legislation; and the machinery of party action was every year growing more perfect. The Senate chose its committees by ballot, and debated their recommendations with a thoroughness which the House, with its more numerous membership, could not often emulate; but the committees of the Senate, no less than the committees of the House, formulated every action decided upon by the party leaders. The chairman of each committee, indeed, enjoyed an initiative in respect of the matters referred to his committee which often escaped the control of the leaders when he chose to ignore them. It was in part because of this new, efficient, and thorough-going way of action in Congress that Presidents and their cabinets fell more and more into the background in the origination of policy. Mr. Douglas had wished to be President: but was much more powerful in his real place of leadership on the floor of the Senate. Mr. Pierce accepted what he planned. He had his way with regard to Kansas and Nebraska as he could have had it in no other capacity than as chairman of the Committee on Territories.

No man could have wished to see his success produce a more dramatic effect. It was instantaneous. Kansas became at once a veritable battle ground. There was

a fatal ambiguity in the law. Did it mean that the people could make their choice with regard to slavery now, while they were yet but citizens of a Territory, through their territorial legislatures, or must they wait until they made their formal constitutions as states and obtained admission into the Union? Whatever its meaning, the matter was evidently to be decided by numbers, by filling the inchoate state with a prevailing majority out of the South or with a prevailing majority out of the North,—by the conquest of effectual occupation. And so each section began to pour its settlers in. Nebraska was out of the question. It lay too far to the northward; no one in the South looked to see slavery make its way thither. But men must go to Kansas, and go at once, ready for any heat of conflict.

It was singular how the strong discipline and self-confident spirit of party held the Democrats together in face of the country's manifest sharp revulsion against what they had done. Too steady for panic, too sure of the practical soundness and efficacy of the radical measures they had entered upon to be seriously disconcerted, they held doggedly on their way. But with the Whigs it was different. Their party had been short-lived at best; they had looked chiefly to the North for support; they had gone to pieces in the election of 1852 as completely and as irretrievably as the Federalists had gone to pieces in the election of 1800; their adherents were afield looking for a new allegiance, a new way of action. Some were simply "Anti-Nebraska men," opponents of the extension of slavery; some knew not how to vote; some crowded, for diversion, into the ranks of the Know Nothings. The elections of 1854 and 1855 brought strange surprises. The

THE NEW YORK
PUBLIC LIBRARY
ASTOR, LENOX
TILDEN FOUNDATIONS

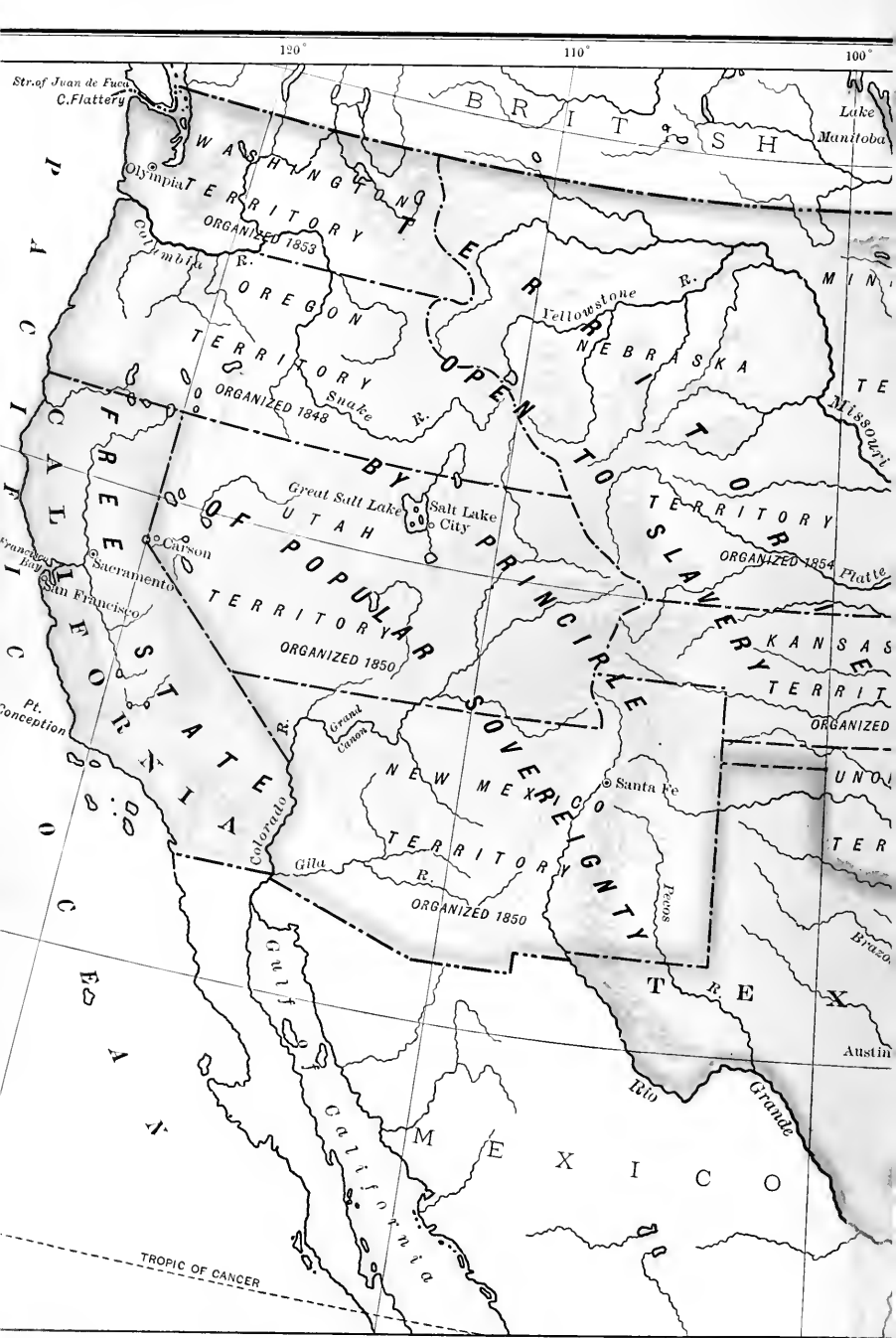



90° 80°
 90° 80°
 MARCH 4TH 1855.

BURMAN & CO., N.

THE NEW YORK
PUBLIC LIBRARY

ASTOR, LENOX
TILDEN FOUNDATIONS

ARMED DIVISION

Know Nothings won a sudden series of successes. In the autumn of 1854 they elected their candidates for the governorship in Massachusetts and Delaware and

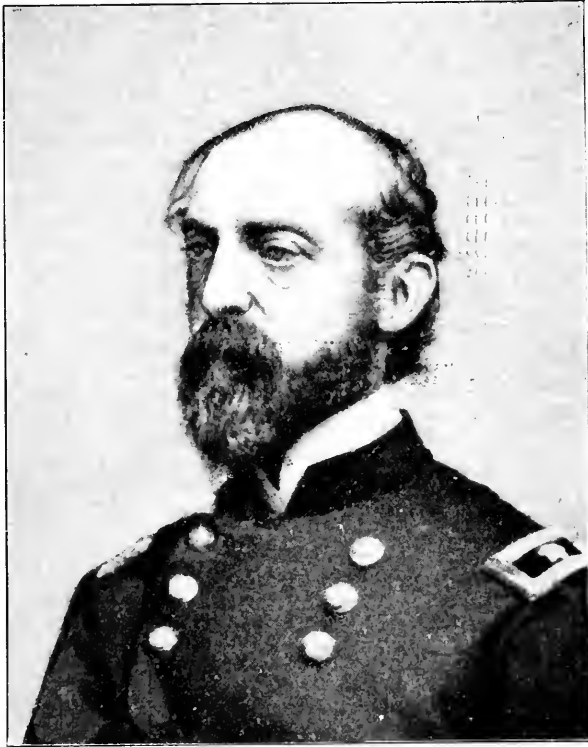

Geo. G. Meade

GEORGE GORDON MEADE

put close upon a hundred members into the federal House of Representatives. In the autumn of 1855 they carried New Hampshire, Massachusetts, Rhode Island, Connecticut, New York, Kentucky, and California, and fell but a little short of majorities in six

of the southern States. Their successes filled the House of Representatives and the offices of government in the States with new and unknown men. The House of Representatives which met in December, 1855, was so variously and whimsically compounded of Anti-Nebraska men, Free Soilers, Democrats, southern pro-slavery Whigs, Know Nothings who favored the extension of slavery and Know Nothings who opposed it, that nothing was certain of it except that it contained a majority against the administration.

But another year (1856) brought the opposition together into a clearly defined "Republican" party, into which all Anti-Nebraska men, whether one-time Democrats or one-time Whigs, whether for a little while Free Soilers or for a still shorter time Know Nothings, were drawn with united purpose. Many things besides Mr. Douglas's revolutionary Kansas-Nebraska bill had given heat and cohesion to their gathering opposition. Before that bill had been introduced the administration had purchased of Mexico (December 30, 1853), through Mr. James Gadsden, of South Carolina, the minister of the United States, forty-five thousand square miles of additional territory, lying at the south of the Gila River, to round out the acquisitions of 1848, the root of controversy and compromise. The year the Kansas-Nebraska Act became law, Mr. Pierce had, moreover, at the solicitation of southern men, directed the American ministers to Great Britain, France, and Spain, Mr. James Buchanan, of Pennsylvania, Mr. John Y. Mason, of Virginia, and Mr. Pierre Soulé, of Louisiana, to confer and report to him upon the desirability of the acquisition of Cuba by the United States. They met at Ostend, in Flanders, and reported that in their

ARMED DIVISION

opinion the acquisition of Cuba would be highly advantageous to the United States; and that, rather than suffer it to be Africanized, as Santo Domingo had been, the United States would be justified in wresting it from



Pierre Soulé

PIERRE SOULÉ

Spain by force, if Spain would not sell. News came now and again, too, of armed expeditions out of the southern ports against some Central American state, and of repeated, though unsuccessful, attempts, by force or strategy, to gain possession of more territory to the south of Texas. There was no evidence that

these lawless raids had any support or countenance from the federal government or from any government, or responsible person even, in the South itself; but the painful impression they made chimed ominously with that made by the Gadsden purchase and the "Ostend manifesto." There seemed an organized effort afoot to extend upon every hand the area of slavery.

The new party of opposition, however, did not perfect its organization or draw its strength effectively together soon enough to win the presidential election of 1856. A remnant of the Whig party was still in the field; the Know Nothings did not know that they had already lost their following, and put candidates confidently into nomination; the Republicans had still to compound a Free-Soil-Anti-Nebraska-Whig creed and find a candidate to please their one-time Democratic supporters,—John C. Frémont, the dashing young soldier and explorer who had found the passes of the Rockies and taken part in the conquest of California. The Democrats, keeping still a virtually unbroken organization in the face of foes divided, elected their candidates, Mr. James Buchanan, of Pennsylvania, and Mr. John C. Breckinridge, of Kentucky, by the safe majority of fifty-two electoral votes. But the popular vote for their candidates had fallen nearly four hundred thousand short of that cast for their opponents; the Republicans had carried every northern State except Pennsylvania, New Jersey, Indiana, and Illinois; and there was in the success of the Democrats, it was to be suspected, nothing but a temporary triumph.

Widespread financial distress clouded the winter that followed the presidential election, and filled all the year 1857 with its deep disquietude, now sharp and

ARMED DIVISION

touched with panic, now a slow, dull lethargy in which merchants and manufacturers and transportation companies and bankers merely waited and did not hope. The sudden growth of enterprise and commerce which



J. C. Frémont

JOHN CHARLES FRÉMONT

had followed the rapid extension of railways and the establishment of steam navigation upon the seas, to which the discovery of gold in California had given added stimulation, and which every item of the steady growth of industry and of the nation itself had assisted to keep in heart these ten years, had inevitably bred

mere speculation, tempted men to unsound ventures, added excitement to confidence, harebrained scheming to the sober making of plans, and credit had at last been overstrained and wrecked by dishonesty, miscalculation, and flat failure. It seemed to public men that the tariff, as it stood, contributed to the distress of the time, because it steadily drew into the Treasury of the United States a surplus which was just so much money withheld from circulation. During the short session of Congress which immediately preceded the inauguration of Mr. Buchanan, all parties amicably united, therefore, in putting on the free list many of the raw materials of manufacture hitherto taxed and in reducing the general level of duties to twenty-four *per cent.*

No debate, no legislation, concerning the tariff had ever been so temperate, so good natured, so full of amicable concert and quick accommodation since the war of 1812. It was a notable sign how the interest of parties had been withdrawn from old questions and fixed upon new. The financial depression and slow recovery of credit which made the year 1857 memorable among men of business constituted no part of the strain of politics. It was of infinitely more consequence that two days after the inauguration of Mr. Buchanan the Supreme Court of the United States uttered, through Mr. Taney, its Chief Justice, an opinion which went even beyond the Kansas-Nebraska Act in its radical rejection of the Missouri compromise. The case was that of Dred Scott, a negro of Missouri, whom his master had taken first into one of the free States and then into the territory from which slavery had been excluded by the legislation of 1820. The negro sought,



Stephen A. Douglas.

NEW YORK: G. P. PUTNAM'S SONS, 1852.

THE NEW YORK
PUBLIC LIBRARY

ASTOR, LENOX
TILDEN FOUNDATIONS

ARMED DIVISION

after his return to Missouri and the death of his master, to obtain his freedom, on the ground that his temporary residence on free soil had operated to annul his master's rights over him; but the court decided against him.



Geo H Thomas

GEORGE HENRY THOMAS

More than that, though it left the proper field of the case itself, and therefore uttered mere *obiter dicta*, in doing so, it went on to declare that the legislation of 1820, which had forbidden slavery in part of the territory of the United States, must be considered unconstitutional

and without legal effect. Slaves, as such, Mr. Taney argued, for the court, were not citizens, in the contemplation of the constitution, but property merely; neither Congress nor the territorial governments, which derived their whole authority from Congress, could legally legislate with hostile purpose against any kind of property belonging to citizens of the States; slave owners might carry their slaves, as they might carry any other property, where they chose within the federal domain; none but a State could exclude their lawful bondsmen.

Here was not only a blow in the face for all Free Soilers, Anti-Nebraska men, and Republicans, but a blow dealt straight at Mr. Douglas's doctrine of popular sovereignty as well. The court's opinion suffered no interference with slavery by any authority but that of a full-fledged State, and the exclusion of slavery from Territories was out of the question. Out of the question in law, it seemed, but yet not in fact. How the fact was to be settled the country had but to look to Kansas to see. There the rush of numbers and the clash of armed men had played a quick drama out, stained by blood and ruffianly force. Men had come first from Missouri near at hand, and out of the slave-holding States which lay back of her, and then from the free States of the northwest and far New England, some upon their own private errands of change or profit or adventure, some in organized bands sent forward by public or private subscription, by individuals or societies, engaged to see the crusade out upon the one side or the other. Men of initiative in the North had accepted the Kansas-Nebraska Act as a challenge to go and take the land and hold it against slavery, by peaceful means or by force; had bought supplies and arms, and had equipped

ARMED DIVISION

sturdy men by the score for the journey and the strife at its end. The lawless of the one faction had vied with the lawless of the other in acts of violence and even

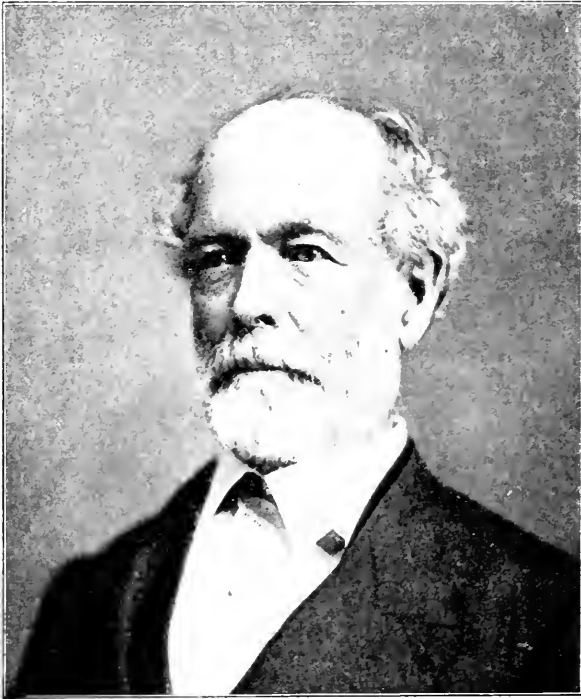

J. E. Johnston

JOSEPH ECCLESTON JOHNSTON

of treachery, and all the country had gazed these three years upon the dark things done in "bleeding Kansas."

Until this year of Mr. Buchanan's presidency the pro-slavery settlers had kept the upper hand and controlled for the most part the legislation of the Territory; but by the autumn of that year their majority was lost,

their control wrested from them by the settlers out of the North, crowding in at last in numbers greater than their own. Their final act of power was to call a constitutional convention and submit to the vote of the people a constitution which established slavery. The question submitted to the people's vote was not, however, the adoption or rejection of the constitution, but merely its adoption "with slavery" or "without slavery." The clauses by which it directly sanctioned slavery were by no means the only clauses which affected the critical matter. It contained, besides, numerous provisions which were not to be affected by the vote, which threw effective safeguards round about existing property in slaves, quite independently of the establishment of a slave-holding system; and great numbers of anti-slavery men, not being suffered to vote against the instrument as a whole, would not vote at all. It was consequently adopted "with slavery" and sent to Congress along with the usual application for admission into the Union. The anti-slavery legislature of the Territory, elected in the autumn of 1857, immediately ordered the instrument submitted as a whole to the people's vote, and it was rejected by an overwhelming majority, the pro-slavery men in their turn refraining from voting.

Mr. Buchanan, finding himself in fact the head of a party whose chief strength lay in the South, and yielding more and more as events thickened to the influence of the southern men in his cabinet, favored the admission of the Territory under the constitution adopted "with slavery," as in technical form at any rate the legal expression of the wish of the people of the Territory. But Mr. Douglas, no mere partisan, after all, but a

ARMED DIVISION

man steadfast in the principles upon which he had professed to act, refused to be a party to the act. He knew, as the whole country did, that this constitution, sent in the name of Kansas, was not in fact the constitution preferred by a majority of its people. To adopt it would be, not the recognition, but the repudiation of popular sovereignty. There were Democratic ma-

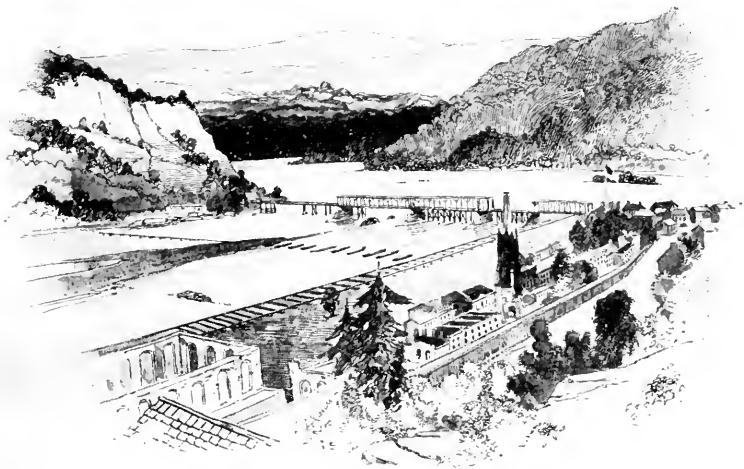

HARPER'S FERRY IN 1859

ajorities in both houses, but members enough followed Mr. Douglas to defeat the resolution of admission, and it failed. A line of cleavage had shown itself within the Democratic ranks, and the plot of politics was sensibly thickening.

Another year, and it was more evident than ever where the issue cut and how the opinion of the country was turning. The elections of 1858 disclosed very serious losses for the Democrats. Five Republican

senators were added to the twenty already in active and aggressive opposition; the Republican representation in the House was increased from ninety-two to one hundred and nine; the President's own State was carried for the Opposition; and no observant man doubted what the causes were. They were indeed fixed with dramatic force in the mind of the whole country by the circumstances of Mr. Douglas's own barely successful struggle for re-election to the Senate. The Republicans of Illinois put into the field against him a man new, like the party itself, but racy of the soil and of the time. Abraham Lincoln was forty-nine years old, Mr. Douglas's senior by four full years; but, though he came late into the view of the nation, he came with toughened fibre, athletic in mind and body. He had struggled out of meanest poverty to a place among the men who led by processes familiar enough upon that rough frontier, where every man had his own way to make, his own training to get, for himself, whether in books or in action; but the genius he had put into the task had wrung out of the old processes a new and greater type of man. He had had the instinct of the student in the midst of affairs and had made himself a master of ideas, and of language as an instrument of mastery. He had devised for himself straight thrusts of speech and a use of words that acted always like the application of light,—spoke like a swordsman who knows not only his fence, but also the temper of his blade and the seats of life which the sword can touch.

Mr. Douglas knew his antagonist, and knew that he had arranged no light matter when he had agreed to meet him in public debate, up and down the State, upon the issues of the day. All the country knew that

ARMED DIVISION

a novel and very striking figure, the figure of an untutored master among men, had emerged upon the general field of politics when it heard what the debate had brought forth. "A house divided against itself,"



John Brown

JOHN BROWN

Mr. Lincoln said, in phrases which stuck in the mind, "cannot stand. I believe this country cannot endure half slave and half free. I do not expect the house to fall, but I expect it will cease to be divided. It will become all one thing or all the other." What, he asked Mr. Douglas, became of the doctrine of popular sov-

A HISTORY OF THE AMERICAN PEOPLE

ereignty if the Dred Scott decision was accepted as law? The territorial legislatures, replied Mr. Douglas, could hold slavery back, if not by actual prohibition, at least by hostile restriction and impediment. Then a territorial legislature can do what Congress itself cannot? asked Mr. Lincoln,—and the country knew, the

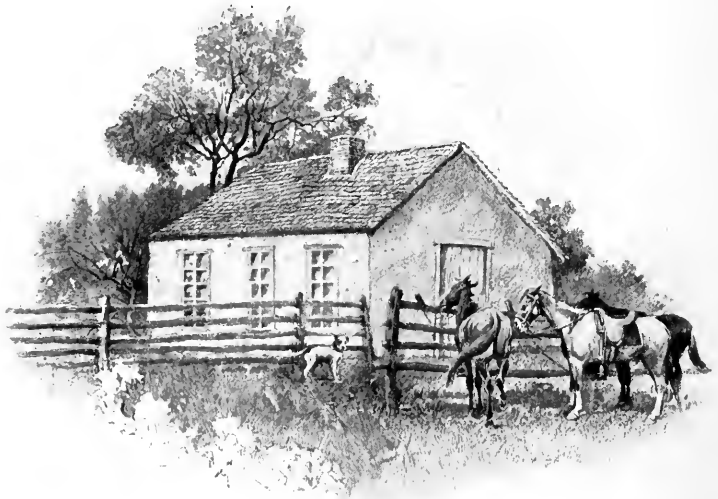

THE DUNKER CHURCH, WHERE JOHN BROWN PREACHED THE NIGHT OF THE RAID

Democrats whom he essayed to lead knew, how embarrassed Mr. Douglas had been for an answer. He won his seat, but he lost his following at the South.

That same year, the elections notwithstanding, Mr. Buchanan urged upon Congress, in his annual message (December 6th), fresh territorial expansion at the South: the acquisition of Cuba, vigorous action on the Isthmus

ARMED DIVISION

against Nicaragua and Costa Rica, and a protectorate over the nearer parts of the Mexican Republic, which appeared to be on the point of going to pieces. No indifference, no hostility abated his zeal in these matters. He could get nothing; the Republicans held the balance of power in the House of Representatives since the election; policy stood still there. But out of doors the rising passion of parties took its natural course.

The autumn of 1859 brought a sinister thing to light which startled the whole country, but the South most deeply, with its disclosure of what passion, though it were but individual passion, might lead to. One John Brown, come out of Kansas for the purpose, attempted of a sudden, on the night of Sunday, October 17, 1859, a liberation of the slaves round about Harper's Ferry, in Virginia, madly hoping to set a general insurrection aflame and bring emancipation on by force. The attempt failed miserably, and Brown was sent to the scaffold; but that was not the whole of the matter. The striking character and self-forgotten passion of the man held the attention and moved the spirits of every one who looked upon the event to heed it. He was a mad fanatic, but no common rascal and adventurer. He had gone, four years before, out of Connecticut, with his four sons, to throw himself into the struggle against slavery in Kansas, and had got a price set upon his head there for lawless violence and massacre; but there was in him the spirit as if of a blind and maddened crusader; he fought and did deep evil, not for himself, but for a cause; and men held their breath at thought of him as if at sudden sight of some fateful omen. To the eyes of the southern men his image loomed big, as the very embodiment of the party

arrayed against them and the institutions they lived under. Brown was found to have obtained money and arms by subscription out of the North. They had been supplied him, it turned out, for use in Kansas, not for use at Harper's Ferry; but the southerners made no discrimination in that matter. In either case, it was aid given to a man who was expected to fight slavery at any cost, and without reckoning of law or consequences. They would not now distinguish between that and the objects of the Republican party itself.

They coupled this fatal raid with the systematic and successful attempts of the northern States to nullify the Fugitive Slave Law. Runaway slaves seized under that law had again and again been rescued by force, and the rescuers had escaped punishment by the action of friendly juries and the systematic application of the writ of *habeas corpus*. Every possible obstacle had been put in the way of the operation of the law by state statutes, — lawyers had been disbarred for acting for those who claimed the runaways, the use of state prisons had been denied, and state officers had been heavily fined for participating in the execution of the federal enactment.

While the impressions made by the unhappy affair at Harper's Ferry were still vivid, while the heat it had engendered was still at its height, the presidential campaign of 1860 came on, and the havoc sectional feeling had made was laid painfully bare. The Democratic party was at last hopelessly rent into factions, divided, as was inevitable, upon the question of standing, with Mr. Douglas, for the principles of the Kansas-Nebraska legislation, of the sovereignty of the people of a Territory no less than of the people of a State, or, with

ARMED DIVISION

the southern men, for the extreme doctrine of the Dred Scott case. No agreement was possible; the men of the one view and of the other had come at last to the parting of the ways. The usual party convention was tried, but was broken at once into factions, each of which tried to rally the party to itself in a separate convention of its own. The one faction nominated Mr. Douglas; the other Mr. Breckinridge, the Vice President. The Republicans, meeting in Chicago, where the ardent enthusiasm of the Illinois men for their newly risen champion was felt at its full, put aside Mr. Seward, whom the country and the party itself had confidently expected to see named, and nominated Mr. Lincoln for President. A third party, heir of the Know Nothings, but strengthened also by many conservative



COLONEL LEE'S MARINES BREAKING INTO THE ENGINE-HOUSE AT
HARPER'S FERRY

men who had despised Know Nothingism and meant now merely to hold the country off, if they could, from all extremes, met and made its nominations also, calling itself the "Constitutional Union" party, and avowing as its simple creed "no political principle other than the constitution of the country, the union of the States, and the enforcement of the laws."

In the election which ensued almost every man who doubted whither to turn with his vote acted, when the day came, with the Republicans, and Mr. Lincoln was elected President. The electoral vote was to be, one hundred and eighty for Mr. Lincoln, one hundred and twenty-three for his three opponents combined. With the exception of four votes won at a hazard in New Jersey, which had divided its votes between Mr. Lincoln and Mr. Douglas, the Democrats had obtained not a single electoral vote in the North or West. Virginia, Tennessee, and Kentucky had cast their votes for Mr. Bell, the nominee of the "Constitutional Union" party; the rest of the South had voted for Mr. Breckinridge. Mr. Douglas was to receive the nine votes of Missouri and the three which New Jersey had withheld from Mr. Lincoln. It was an ominous thing, nevertheless, that, despite his undoubted majority in the electoral college, the election had gone against Mr. Lincoln, reckoning by the vote of the people, by a majority of close upon a million out of a total vote of but a little more than four millions and a half. In almost every State that Mr. Lincoln had carried the vote for Mr. Douglas had trodden close upon the heels of his own. The total vote had been 4,682,069. Of this Mr. Lincoln had received 1,866,452, Mr. Douglas 1,376,957, Mr. Breckinridge and Mr. Bell together 1,438,660. In the

ARMED DIVISION

North and West alone the vote cast against Mr. Lincoln had been 1,575,000. In Oregon and California, whose electoral votes he was to receive, the aggregate opposition vote had been nearly twice that cast for him. It was a deeply perilous thing that such

Springfield, Ill. May 23, 1860

Hon: George Ashmun,

President of the Republican National Convention.

Sir

I accept the nomination tendered me by the Convention over which you preside, and of which I am formally appointed in the letter of yourself and others, acting as a Committee of the Convention, for that purpose.

The declaration of principles and sentiments, which accompanies your letter, meets my ~~approval~~ approval; and it shall be my care not to violate, or diverge in, in any part—

Imploring the assistance of Divine Providence, and with due regard to the views and feelings of all who were represented in the Convention; to the rights of all the States, and territories, and people of the Nation; to the inviolability of the Constitution; and the perpetual union, harmony, and prosperity of all, I am most happy to co-operate for the practical success of the principles declared by the Convention—

Your obliged friend, and fellow citizen
A. Lincoln

FACSIMILE OF LINCOLN'S LETTER OF ACCEPTANCE

a victory, won upon such issues, should have been won so narrowly, and through a minority of the nation.

Before Mr. Lincoln was inaugurated seven southern States had withdrawn from the Union, and revolution was upon the country. The southern leaders of the extreme school of state rights and the doctrine of the

Dred Scott case had consciously, avowedly staked everything upon the election, and accepted the result as conclusive of what self-respect and political exigency demanded of them. They looked upon this coming into power of the men of a minority which had set itself to check slavery and to shut the slave-holding States in, in order that they might be thrust from their place in the politics of the nation, as a thing fatal to the very principles of the partnership formed in those first days when the constitution had been framed, and accepted as a pledge of equality between the States. The Republican party had, indeed, always and with all proper emphasis disavowed any wish or intention to lay any hand of molestation or change upon the domestic institutions of the South itself. The anti-slavery men who were abolitionists were little more numerous in 1860 than they had been in 1840, and those who spoke for the Republicans vehemently disclaimed all alliance or sympathy with them. But, though they did not mean to lay the axe to the root of the tree, the partisans of Mr. Lincoln did mean to gird it about and let it die where it stood, as one of the senators from Louisiana passionately told them. They meant by law and force to keep slavery from getting any growth or outlet whatever. They meant also to nullify, if they could not repeal, the laws whose adoption the constitution commanded for the apprehension and return of runaway slaves, and put the whole system of slavery, so far as they might within the formal limits of the fundamental law, beyond the recognition or countenance of federal statute. Their creed and their actions alike were compounded of hostility towards the South; and the challenge of their success was direct and unmistakable.

I close. We are not our country's enemies
 or enemies, but ~~country~~ fellow countrymen
 and brethren. Although passion has strained
 our bonds of affection so badly they almost
~~will be broken~~ they will not. I am
 sure they will not be broken. The
 mystic chords which proceed from every
 to so many battle fields and graves to
 many patriot graves and people through
 all the hearts are beating all the
 hearts in the broad continent of our
 land yet. I am again I am sure in
 this great union when ~~the nation~~
 finally reached upon upon by the ~~best~~
 angels guardian angels of the nation

MR. SEWARD'S SUGGESTION FOR THE CLOSE OF MR. LINCOLN'S
 INAUGURAL ADDRESS

THESE WORDS ARE TO BE REPEATED, WITH A FEW MODIFICATIONS, AT THE CLOSE OF THE ADDRESS. THE LAST SENTENCE
 SHOULD BE REPEATED IN THE FOLLOWING MANNER: "I AM SURE THEY WILL NOT BE BROKEN."

I am loth to close. We are not enemies,
 but friends. We must not be enemies. Though passions may
 have strained, it must not break our bonds of affection.
 The mystic chords of memory, stretching from every battle
 field, and patriot grave, to every living heart and hearth
 stone, all over this broad land, will yet swell the cho-
 rus of the Union, when again touched, as sure they will
 be, by the better angels of our nature.

CLOSING PARAGRAPH, IN MR. LINCOLN'S HANDWRITING, OF THE
 INAUGURAL ADDRESS

Men of southern mettle could not disregard or decline it.

Pride and self-vindication seemed the more imperatively to command that it should be accepted by the southerners because of what their opponents had said, with sneer and taunt and bitter detraction, about the system of slavery, which they maintained and stood for. No man who candidly looked back to the indisputable records of the colonial time could justly deem them responsible for its establishment. They had very earnestly and again and again protested against the traffic in slaves which the crown permitted, and the inevitable growth of servile labor which that hateful traffic brought in its train, to the thrusting out of white men and of the free labor which everywhere else gave dignity and efficiency to English communities; but the authority of king and parliament alike had forced and fostered it until it had seemed as if the entire slave trade of the world centred at their ports. Free hired labor had been once for all driven out, whether they would or no; the black people had multiplied among them until emancipation became a thing not to be ventured upon; work in the wet southern rice fields, upon the broad acres of tobacco, amidst the sugar cane, and out in the hot furrows of grain came at length, with long use and fixed custom, to seem a thing which only the African could stand. The northern States, ere separation from England set them free to be quit of slavery, if they chose, by emancipation, had diligently sought to rid themselves of the few negroes who had unsuitably found places of service in them by sending them also, as occasion offered, to the southern slave markets. Finally, when fate and slow habit and their

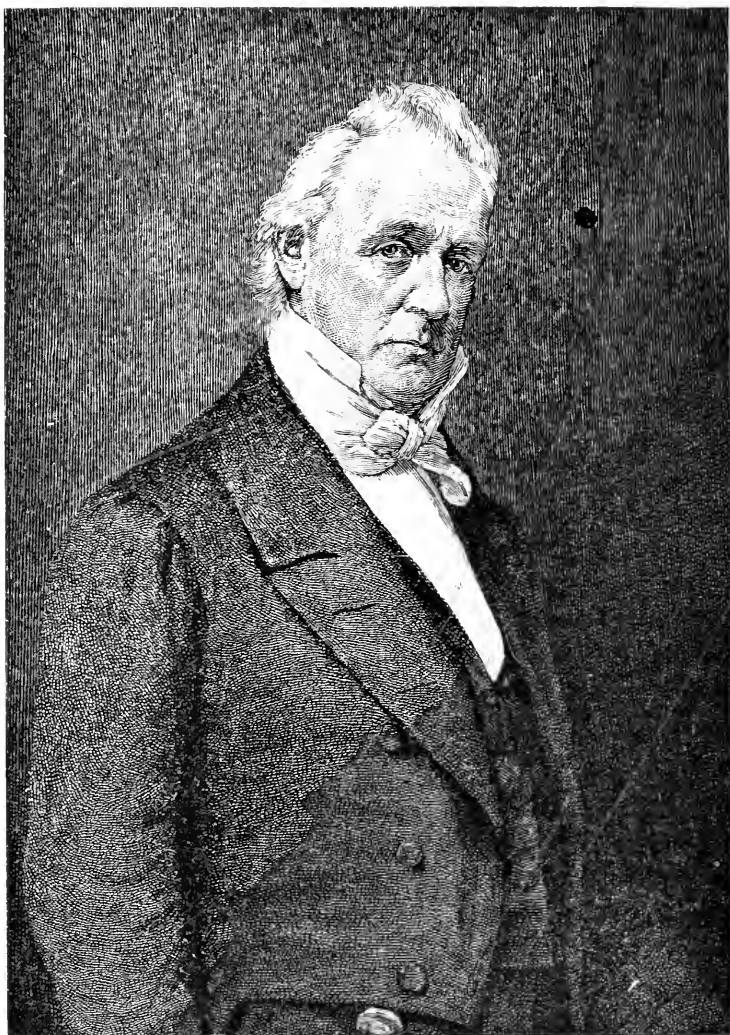

James Buchanan

JAMES BUCHANAN

own very multitude had fixed them, millions strong, upon the South, a base and support upon which all society seemed to rest, their labor, already indispensable, became of a sudden immensely profitable in the blazing sun of the cotton fields by reason of the invention of Whitney's cotton gin.

The system of slavery necessarily deprived the South of a body of small, yeomen farmers; but small farms abounded, nevertheless. A great majority of the southern farmers owned no slaves at all. If they could not afford to hire negroes from some neighboring planter who had hands to spare, they worked their fields themselves, like farmers everywhere. If they could afford to hire a negro or two, they worked with them, side by side, in the fields.

It was the accusation of moral guilt in the matter of slavery that stung the southern men most intolerably. They knew with what motives and principles they administered it, and felt to the quick the deep injustice of imputing to them pleasure or passion or brutal pride of mastery in maintaining their hold upon the slaves. Many a thoughtful man amongst them saw with keen disquietude how like an incubus slavery lay upon the South; how it demoralized masters who were weak, burdened masters who were strong, and brought upon all alike enormous, hopeless economic loss. Although the productive labor of the South was almost exclusively agricultural, more rich land lay waste and untilled there than in any other region of the country held in use and occupation. The indolent slaves did not work as free laborers would have worked, and could not be made to. Intensive methods of farming were out of the question. Land had first to be used, without artificial renewal,

ARMED DIVISION

and then allowed long to lie fallow and get its recuperation by the slow processes of nature. The narrow margin of profit under such a system of labor and tillage constantly threatened to disappear altogether. And



A. S. Johnston

ALBERT SIDNEY JOHNSTON

yet the care of the slaves, their maintenance like a huge family of shiftless children, remained a duty and a burden which the master could not escape, good season or bad, profit or no profit.

Travelers could find whatever condition they looked

for among the slaves. Where it was necessary to assemble and keep them hundreds strong upon remote plantations, lying in some malarial district upon the coast or in the river bottoms, where they could live but their master could not, they were often enough hard driven by brutal men, themselves mere hired drudges, who cared for nothing but to get the exacted stint of work out of them. But where the master was himself at hand there was almost always moderation, a firm but not unkindly discipline, a real care shown for their comfort and welfare. They were taught handicrafts, because each plantation was of necessity, in respect of every simpler kind of work, a complete industrial community. It was necessary that it should maintain its own shoemakers, tailors, carpenters, bricklayers, blacksmiths, and men of all work. There was seldom any town near at hand to supply even its commoner wants. The punishments each master meted out he allotted rather as magistrate than as master. The offences which he punished would most of them have gone before a magistrate had the offenders been freemen. "On principle, in habit, and even on grounds of self-interest, the greater part of the slave owners were humane in the treatment of their slaves,—kind, indulgent, not over exacting, and sincerely interested in the physical welfare of their dependants," said an eminent northern man of letters, speaking of what he saw in 1844.

Domestic slaves were treated with affection and indulgence, cared for by the mistress of the household. The life of a southern planter's wife was a life of executive labor, devoted chiefly to the care and training of her slaves. Social privilege and the proud *esprit* of

their class bred in southern masters a sense of the obligations of station; and the spirit of the better men ruled the conduct of the less noble. The demoralizing influences of the system were checked as much as it was in human nature to check them. Southern gentlemen despised a slave trader as heartily as any northern man did, necessary though his occupation seemed to be; sold and bought slaves by private arrangement when they could; and sought in every way to keep the worst features of the system at a minimum.

That very fact, their very consciousness that they exercised a good conscience in these matters, made them the more keenly sensitive to the bitter attacks made upon them at the North, the more determined now to assert themselves, though it were by revolution, when they saw a party whose chief tenet seemed to be the iniquity of the South, about to take possession of the federal government. They had the inevitable haughty pride of a privileged class. Probably not more than one white man out of every five in the South was a slave holder; not more than half had even the use or direction of slaves. Hundreds of the merchants, lawyers, physicians, ministers who were the natural ruling spirits of the towns owned none. But the men who were slave owners were the masters of politics and of society. Their sensibilities were for all practical purposes the sensibilities of the South; and for close upon forty years now it had seemed as if at every turn of the country's history those sensibilities must be put upon the rack. The Missouri compromise of 1820 had treated the institution of slavery which they maintained as an infection to be shut out by a line as if of quarantine. The alarming insurrection of the slaves of southeastern

Virginia under Nat Turner in 1831; the English Act of Emancipation and the formation of the American Anti-slavery Society in 1833; the slow and dangerous Seminole war, which dragged from 1832 to 1839, and was as much a war to destroy the easy refuge of run-away and marauding negroes in Florida as to bring the Indians, their confederates, to submission; the critical Texas question; the Mexican war and the debatable Wilmot proviso; the Kansas-Nebraska Act, the "free-soil" campaign, the break-up of the Whigs and the rise and triumph of the Republicans:—it had been a culminating series of events whose wounds and perplexities were always for the South. Southerners might have looked upon the election of Mr. Lincoln as only a casual party defeat, to be outlived and reversed, had it not come like a dramatic *dénouement* at the end of the series. As it was, it seemed the last, intolerable step in their humiliation.

The North had not realized as the South did what the election of 1860 meant. Southern men had been keenly conscious that the issues of revolution hung upon it. That consciousness explained the votes of Virginia, Tennessee, and Kentucky, cast for Mr. Bell, the candidate of the Constitutional Union party. In other parts of the South as well votes by the tens of thousands had been cast for the candidates of that party, by men who loved the Union, dreaded revolution, prayed for peace, and sought this means of escape from the fatal antagonisms of the regular parties. Northern voters, too, had been uneasy; but the air of opinion about them had not been charged as the southern air was with the keen forces of passion put to its final test. There was not among them the universal feeling which stirred

in the South, that politics had come at last to a breaking strain.

South Carolina, alone among the States, still chose her presidential electors through her legislature. Having chosen her eight electors upon the appointed day in 1860, and instructed them to vote for Mr. Breckinridge, her legislature remained in session to learn the result, prepared to take action at once should what it

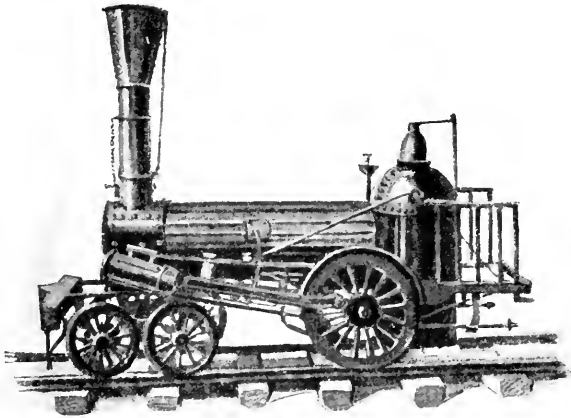

THE "GEORGE WASHINGTON" LOCOMOTIVE, 1835

feared come to pass. When the news came that a majority in the electoral college had been secured for Mr. Lincoln, it immediately called a state convention, provided for the purchase of arms, and adjourned. On the 20th of December following the convention which it had called, sitting in Charleston, adopted an ordinance which solemnly repealed the act of the convention of the 23d of May, 1788, whereby the State had accepted the constitution of the United States as part of its fundamental law, together with all subsequent

ratifications of federal constitutional amendments, and formally declared the union hitherto "subsisting between South Carolina and other States, under the name of the United States of America," dissolved and ended. By the first day of February following Mississippi, Florida, Alabama, Georgia, Louisiana, and Texas had also seceded. On the fourth day of February (1861) delegates appointed by the several conventions of the seceding States met in convention at Montgomery, Alabama, to frame a provisional constitution and choose a provisional executive for a separate southern Confederacy. Mr. Jefferson Davis, until a few weeks before a senator of the United States from Mississippi, was chosen provisional President, Mr. Alexander Hamilton Stephens, until two years before a member of the federal House of Representatives from Georgia, provisional Vice President. In March a permanent constitution was adopted, to take effect the next year. True to their theory of government, the southern States had returned to the political methods of 1788. Each State had, not by popular vote, but by sovereign convention, withdrawn from the Union, as she had acceded to it. The same conventions that had chosen the delegates sent to Montgomery ratified the constitution which they framed, and authorized the inauguration of the new Confederacy.

It was corporate action, taken with the initiative and promptness of men skilled alike in the theory and in the practice of constitutional action, as Mr. Calhoun and all southern statesmen expounded it. They assumed that, since each of their States had entered the Union of its own accord, as into a free partnership, and might have declined to enter it, it was clearly within

ARMED DIVISION



VICKSBURG, MISSISSIPPI, 1863

its privilege to withdraw when just cause for withdrawal seemed to exist. It was an assumption the theory of which would hardly have been seriously questioned while the generation lived which made the Union; though that generation would have been as ready as any that followed it, no doubt, to make protest, it might be of arms, against actual secession. Neither change of thought nor change of political conditions in the nation at large had altered the thought of the South with regard to the character of the government; for she had not herself changed, and her own thought had kept steadfastly to the first conception of the Union. But to the rest of the country such a theory had become little less than incredible, often as southern statesmen had expounded and pressed it. The constitution of a nation, though written, cannot remain a mere legal document. The life of each succeeding generation must inevitably be read into it, if only because it must be men of successive generations who read and interpret

it. They can but comprehend it in terms of their own lives. It must become the vehicle of their growing thought, if it is to suffice them; must serve as the skeleton frame of a living organism. For a majority of the nation no conception of the Union was now possible but that which Mr. Webster had seemed to create and bring once for all to their consciousness in that debate with Hayne which had been a turning point in all men's thinking. A Union full of new States, themselves its own creation; a people recruited out of almost every civilized nation of the world, bound together by railway and telegraph, busy with enterprises which no State or section could imprison within local boundaries, quick and various, as in the old days, but now at last conscious of its unity and its organic integrity, could not turn back to a particularistic creed which might make every jar of politics threaten to break its joints asunder.

And so it happened that the action of the southern States took the North by surprise. Often as they had heard the doctrine of secession preached, the northern people looked upon it as a singular and novel thing when they saw it thus put into practice. The spirit, precision, and concert, the despatch and radical thoroughness with which the southern men acted, as if upon a programme familiar and matter of course, filled the North for a little with mere dull amazement. Their quick pace in revolution, their confidence as of men who had no doubts or misgivings, confused and for a brief space dismayed those to whom the North naturally looked for counsel and guidance. The very month South Carolina seceded, before any other State had taken action to join her, she sent commissioners to

ARMED DIVISION

Washington to arrange, as of course, for a division of the national debt and for the formal transfer of all national property lying within the State; and Mr. Buchanan knew not what to do. He promptly and unequivocally denied the right of the States to secede; but he knew, he said, no legal means of actually preventing their secession. The law officers of the gov-

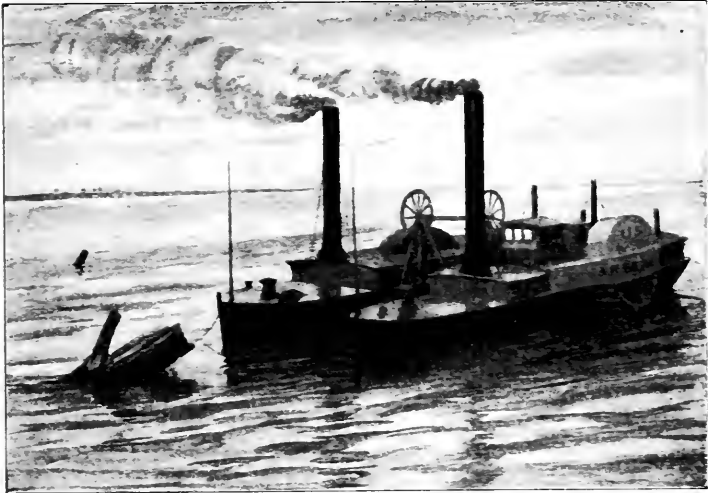

A SNAG BOAT ON THE MISSISSIPPI RIVER

ernment could give him no light: from no quarter came any clear counsel or unhalting judgment in the matter. Congress attempted measures of compromise. A Peace Conference assembled, at the suggestion of Virginia, to discuss plans of accommodation, and a committee of the Senate concurred in its recommendations: the extension of the Missouri compromise line to the Pacific, the positive establishment of slavery by law south of that line, and compensation from the federal treasury

for all fugitive slaves rescued after arrest. But Congress seemed partially dissolved, ere the winter was over, by the withdrawal of members from the States which one by one seceded; nothing could be done while it seemed insecure of its very membership; there was nowhere agreement or coolness or courage enough to make any plan feasible.

The southern men withdrew from the cabinet, as they withdrew from the House and the Senate; southern men by the score left also the lower ranks of the civil service and went home to offer their services to the new Confederacy; southern officers withdrew from the army and the navy as their States seceded; the authorities of the newly federated States took possession, as they left the old Union, of the arsenals, forts, custom houses, and post offices within their territory. Before the authorities at Washington had made up their minds what to do every fortified place in the South was in the possession of the Confederacy except Fortress Monroe in Chesapeake Bay, Fort Sumter in Charleston harbor, Fort Pickens at Pensacola, and the fortifications near Key West. All familiar things seemed dissolving, and Mr. Buchanan scarcely knew what government he had to handle. Some of the men about him upon whom he was obliged to depend believed that the southern states had a right to do as they were doing; others denied their right but knew not how to check them; still others knew what ought to be done but had not the courage or the initiative to do it. All the country waited, the President himself included, to see what Mr. Lincoln and his Republican advisers would do.

Men noted the sad and anxious eyes of the new President; noted also, with a certain deep misgiving, his

LINCOLN MAKING HIS FIRST INAUGURAL ADDRESS

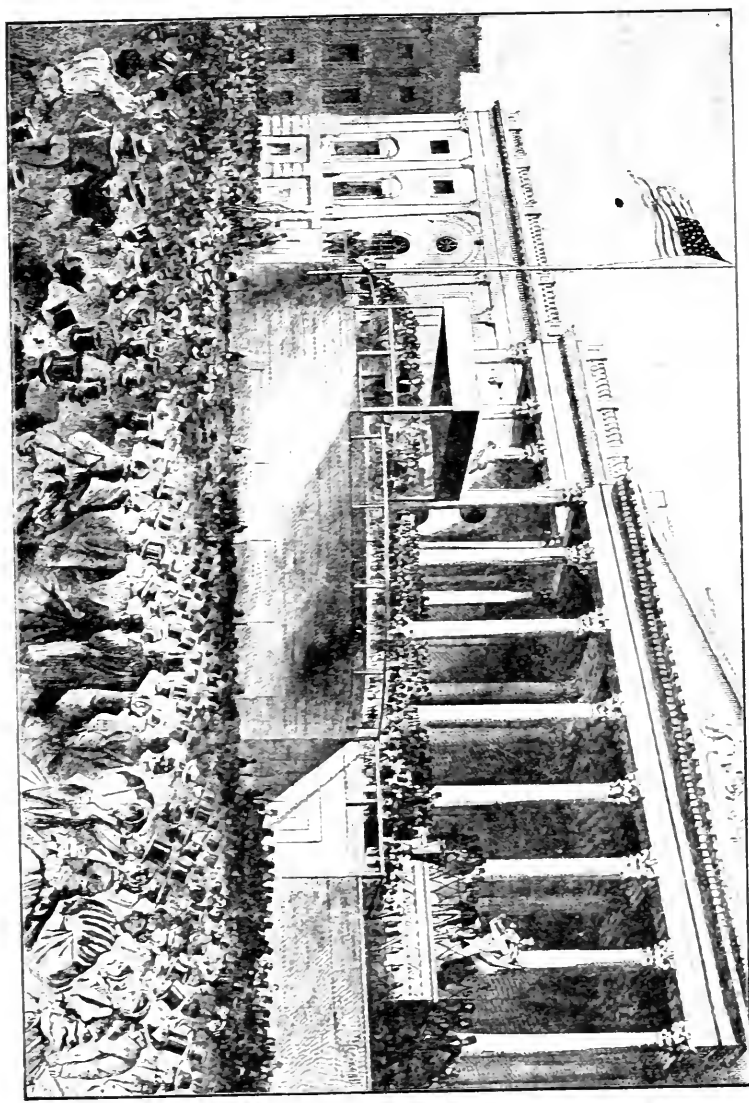

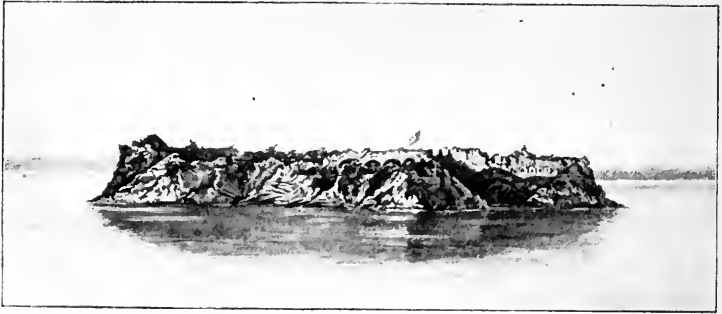

FORT SUMTER ON NOVEMBER 10, 1863

gaunt and uncouth figure, as of a man too new, too raw, too awkward, too unschooled in affairs for the terrible responsibilities and tangled perplexities of the great office he undertook. They did not know the mastery of the man; they did not see that the straight fibre of this new timber was needed to bear the strain of affairs grown exigent beyond all common reckonings. There was the roughness of the frontier upon him. His plain clothes hung unthought of on his big, angular frame; he broke often, in the midst of weighty affairs of state, into broad and boisterous humor; he moved and did the things assigned him with a sort of careless heaviness, as if disinclined to action; and struck some fastidious men as hardly more than a shrewd, good natured rustic. But there had been a singular gift of insight in him from a lad. He had been bred in straitened, almost abject poverty; his shiftless father had moved from place to place in search of support and shelter for his growing family, and had nowhere got for them more than a bare subsistence; and yet this lad had made even that life yield him more than other boys got from a formal schooling. He matured as slowly as another;

his life quietly kept pace with the simple folk who were his neighbors, no vital sign of his special gifts giving noticeable prophecy of what he was to be; but there came a power of mastery into his mind, nevertheless. He took pains to get to the heart of what others about him but half understood; he used his wits for argument and observation as another lad might have used them for play, and made the use of words, the exact speech which hit his meaning always at the centre, his method of analysis. And so his mind had filled as each item of his experience made its record, as each glimpse of the world came to him. He had made a career for himself in his State which culminated in his debate with Senator Douglas, to which all the country paused to listen; and he was ready to be President by the time he became President. He called both Mr. Seward and Mr. Chase, the hitherto accepted leaders of his party, into his cabinet, the one as Secretary of State, the other as Secretary of the Treasury; but he associated others with them who were of other views and of his own personal choosing; and he himself made his own choice of policy.

His breeding among plain people like himself, accustomed to respect law with simplicity and obey it without subtlety, gave him the direct vision which politicians lacked. He revered the constitution, had sworn to preserve and defend it, and would not "take an oath to get power and break the oath in using that power"; but he viewed his duty in the large, and declared it his conviction that it would be breaking that oath, and not keeping it, if, "to save slavery or any minor matter," he should "permit the wreck of government, country, and constitution all together." He sought

to combine conciliation with this clear purpose to preserve the Union; but while those about him swung from this measure to that and were weak in their excitement, he was only patient and watchful, waiting for opinion and the right day of action.

The time came when, early in April, 1861, word was sent from Washington to the governor of South Carolina that Fort Sumter would be reinforced and provisioned against seizure. The message was sent on April 8th. On the 12th fire was opened upon the fort; on the 14th, ere reinforcements could reach them, its little garrison surrendered. On the 15th Mr. Lincoln called, by proclamation, for seventy-five thousand volunteers. Upon that signal, four more southern States seceded: Arkansas on the 6th of May, North Carolina on the 20th, Virginia on the 23d; and Tennessee on the 8th of June. Issue was made up, and all men knew what it meant, — not compromise, but war.

The southern leaders had not at first expected this. They had thought to bring on a constitutional crisis, but not a civil war? They had meant at any hazard to make good their rights under the federal arrangement, and had deliberately resorted to secession because they thought that better terms could be made out of the Union than in it; but they had expected their opponents at the North to come to terms. Their people had followed and upheld them upon that expectation, and would not willingly have followed them on any other. But when the sound of the guns at Sumter was heard it became at once another matter. The thrill of a new purpose and passion shot through the country, north and south. It was with the one side as with the other.

THE NEW YORK
PUBLIC LIBRARY

ASTOR, LENOX
TILDEN FOUNDATIONS



SLAVERY IN THE U



GULF OF MEXICO

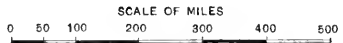

THE NEW YORK
PUBLIC LIBRARY
ASTOR, LENOX
TILDEN FOUNDATIONS

ARMED DIVISION

The southern people would not at the first choice have deliberately set themselves with open eyes to bring a war of revolution on; the people of the North, as conservative of law and of right as the men of the South, drew back, at the first shock and surprise of secession, from coercion or violence, questioned anxiously what they should do, and hesitated as their government did.



INTERIOR OF FORT SUMTER AFTER THE BOMBARDMENT, DECEMBER, 1863

Mr. Seward, of the President's own household, made the amazing suggestion that the slavery question be ignored and the country drawn together to support some aggressive stroke of foreign policy, which should rekindle the national feeling and fill all sections alike with the old temper of patriotism, the South with the rest. It was the sound of war and the call for men that changed the very atmosphere, north and south alike, and set all thoughts in a new channel. Richmond was made

the capital of the Confederacy, instead of Montgomery, as if to put the officers of its government at the front, the northern and southern capitals face to face. Mr. Davis called for volunteers in the South, as Mr. Lincoln did in the North; and the call was responded to eagerly and at once, in the one section as in the other. Even then men were slow to realize the awful business in hand; expected the fighting to be brief, accommodation or surrender to come at once. In the South men flocked to the rallying places and set out with their regiments in blithe spirits, as if for a holiday excursion, not knowing the grip of fate that had closed upon them. But a little while, and these hallucinations had passed away.

The war which ensued disclosed its real nature soon enough. For a year it lingered and was desultory, without plan, speed, or vigor, as if both sides waited, as indeed they did, to muster their resources, contrive a proper organization for the struggle, and discover each beyond a peradventure the temper and purpose of the other. But after that there was neither doubt nor pause in the desperate business, and all the world saw how the flames of civil war had enveloped a whole continent. It was a noteworthy thing how prompt and decisive the grapple of the sections was, for all there had been at first long months of doubt and hope, of confused preparation and all the slow processes by which conservative men adjust themselves to the exigencies of a revolutionary crisis. In the South there was a government to make, as well as an army; in the North a government to remake, a civil service to reconstitute. A year was needed to supply administrative means and make men and methods ready, on the one side as on the other. But a year sufficed.

ARMED DIVISION

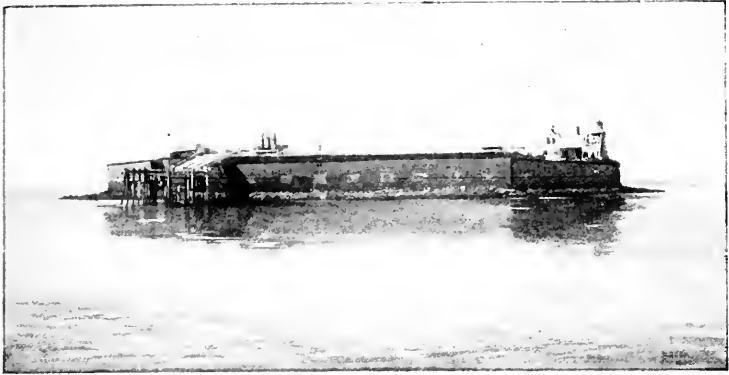

FORT SUMTER, AS REBUILT

Actual fighting, no less than strenuous efforts to be ready for it, had added its sharp definition to all else that the year disclosed. In July (1861) General McDowell had moved with the new federal levies from Washington southward, for a stroke at Richmond. At Bull Run, on the 21st, he had met the confederate forces under Generals Beauregard and Joseph E. Johnston, and after a stubborn and sanguinary battle had been thrown back in utter rout, his regiments not to be kept together because of the panic and confusion of their flight. But it had been a battle and nothing more. The troops on the one side as on the other were raw volunteers; both governments had hoped until the other day to see the conflict ended by a mere show of force or by some sudden stroke, and the confederate commanders were as little prepared to follow up an advantage as their opponents would have been. For a moment the South thought that this battle was all; the confederate troops themselves believed that it was, and incontinently set out in crowds for their

homes, without leave taken. In fact it had only shown that there must be set campaigns and a war of conquest.

Down all the long border between North and South which followed the river Ohio to the Mississippi, the lines had been made clear, the while, which were to be the boundaries of the Confederacy, its outer lines of defence. The western counties of Virginia, beyond the long southwestern line of the Blue Ridge, sympathized, in this issue between slavery and the Union, with the men of the North, not with the men who had carried their State out of the Union, and federal troops, operating there out of Ohio under General McClellan, drove the detachments of confederate volunteers sent against them back over the mountains. In Kentucky also and Missouri slowly gathering armies out of the North pressed the frontier of secession in; and kept the great stream of the Ohio open beyond its junction with the Cumberland and the Tennessee, flowing southward, all the way to the Mississippi itself. Missouri, though at first it had seemed as if the other faction would control her, was held off from co-operation with the Confederacy by the sentiment of her own people. Kentucky, too, slave State though she was from of old, refused to cast in her lot with the seceding States about her; and confederate forces, though they operated for a little while within her territory and found many sympathizers and partisans there, and many men willing to swell their ranks, operated almost as if upon alien ground and kept their lines at constant hazard. These, then, it presently appeared, were the long extended frontiers, from the Potomac, upon which the national capital lay, through the far Cumberland Gap to the Mississippi at Columbus



SERGEANT HART NAILING THE COLORS TO THE FLAG-STAFF,
FORT SUMTER

in Kentucky, from which the northern armies, growing in strength with every month, must strike in at the defences of the South.

Mr. Lincoln called Congress to assemble in extra session on July 4, 1861; and it addressed itself very heartily to the task of supplying the government with means of mastery. It voted the moneys asked for by the Executive, and the loan necessary to supply them; authorized the President to call for five hundred thousand volunteers; declared a blockade of the southern ports; gave explicit statutory definition to conspiracy against the government; and provided for the confiscation of all property used against it. In the regular session which presently followed, in December, it set out at once, in systematic wise, upon the policy of aid and taxation by which it meant at one and the same time to increase the resources of the country and put them at the service of the government. By midsummer, 1862, its programme was complete and enacted into law. Tariff duties were increased at every point at which domestic producers could be protected against foreign competition, and direct taxes were laid upon the products thus favored: specific taxes on iron, steel, paper, coal oil, leather, and a few other manufactures put upon a special list, and on other manufactures a general tax *ad valorem*. A liberal charter was given for a Union Pacific Railway which was to bind the two coasts of the continent together and give an eastern outlet to the produce of the West, and with it were given immense grants of public land along its route in aid of its construction. "Homestead" plots of the public land were offered at a nominal price to heads of families who would settle upon them in the West; and large sections of the public domain

ARMED DIVISION

were voted to the western States in aid of the establishment of agricultural colleges,—in order that the spread



David D Porter

DAVID DIXON PORTER

of population and of productive industry might be more than ever quickened and the accumulation of wealth forced on apace; while at the same time a general income tax was established, railway, steamboat, and

express companies were required to pay to the government a percentage of their gross receipts, and various occupations were closed except to those who would take out federal licenses. It was a policy of nurse and use which could not fail to yield the sinews of war. It meant that the resources of the North were to be added to and diversified at the very time they were being spent.

It had already become evident that the federal government must look for no sympathy from abroad in its effort to prevent secession. The sympathy of foreign governments, it was plain, if the events of the first year of the anxious business were to be read as evidence, was with the South, not with the North. It was likely they would observe very complacently any process of war or disintegration which promised to break the power of the huge republic growing up in the west, ere its rivalry in trade and influence should menace them. The blockade of the southern ports was, moreover, a direct blow at a lucrative trade in which more than one of them was interested. Immediately upon receiving news of Mr. Lincoln's proclamation of the blockade and of Mr. Davis's answering offer to grant letters of marque and reprisal against the commerce of the United States both France and England had issued proclamations of neutrality which gave to the confederate government international standing as a belligerent; and before the year was out an ugly incident seemed for a moment to threaten war with England.

The most influential classes in England were known to sympathize with the South; hundreds of English factories must stand idle and thousands of workingmen be brought to the verge of starvation, if the South, the great cotton field of the world, was to be shut against

ARMED DIVISION

commerce; and the southern leaders were prompt to seek England's active countenance. They sent commissioners over sea both to England and to France, to ask recognition: to England Mr. James M. Mason, of Virginia, a grandson of George Mason, the states-

Committee of the
Conventions.

John Tyler
 Wm. Ballard Preston
 S. M. Moore
 James P. Holcombe.
 James C. Bruce
 Lewis E. Harris
 Alexander Stephens
 Comodoro P. P. de la Torre

SIGNATURES OF THE COMMISSIONERS OF VIRGINIA AND THE SOUTHERN CONFEDERACY

man of the Revolution; to France Mr. John Slidell, of Louisiana. Leaving Charleston for the West Indies, they took passage at Havana on the English steamer *Trent* for England. On the 8th of November the steamer was overhauled in the Bahama channel by a United States man-of-war, and the commissioners were taken from her and carried prisoners to Fort Warren, in Boston

harbor. It was a gross breach of international law, and of principles which the United States government had itself always been forward to insist upon; and England made instant protest, significantly accompanied by preparations for war. The act was disavowed and the prisoners released so soon as the matter was looked into. Mr. Lincoln had no mind to take any false step or cast any doubt on the principles of his government at such a juncture. But the unpleasant feelings provoked by the unfortunate affair were not so easily put by. War between the two nations had come close enough to give both a very disturbing glimpse of possible fatal antagonisms.

The spring of 1862 saw armies upon all the long borders of the Confederacy and fleets upon the coasts and on the western rivers. The area of the war was defined. Before the end of the year its whole scope and character were determined. In the West stroke after stroke of the federal arms forced the confederate lines southward. The accumulating northern armies and flotillas broke their way down the valleys of the western rivers like an irresistible, crushing weight. In the East, on the contrary, all things hung doubtful. The federal commanders there had not the gifts of the men in the West and fought against antagonists who outplayed them at every move. They found no way to concentrate their force upon the southern armies; were puzzled how to take the best way of attack and yet keep Washington covered; and Richmond seemed more inaccessible than the heart of Alabama.

Men who had the character and the capacity to succeed in the field made their way one by one to federal command in the West at the very outset: conspicuous

ARMED DIVISION

among them Ulysses Grant, a quiet soldier whose qualities only a day of action could bring out. He had won a first lieutenancy at twenty-five in the Mexican war; but few except his immediate superiors had noticed how his capacity had shown itself upon occasion in that fighting. He came of plain stock in which there was small impulse of achievement; his faculties fell dull in all ordinary seasons; there was a rustic simplicity about him which made him pass unnoticed among

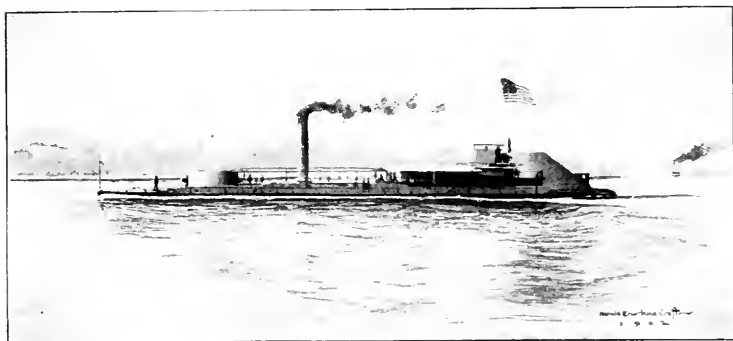

THE OSAGE, TYPE OF IRON-CLAD USED ON THE MISSISSIPPI RIVER

strangers, a lack of self-assertion which rendered him disinclined to quarrel with obscurity. He had withdrawn from the army at thirty-two because the empty routine of a soldier's life worked a deep demoralization upon his easy-going nature when no action of consequence was in hand; but at the outbreak of the war he had enlisted again, as a volunteer, and had been given command of southeastern Missouri with the rank of general of brigade in the volunteer service.

Then it was that the qualities which had slept in him, save for a few glimpses of the day amidst the fight-

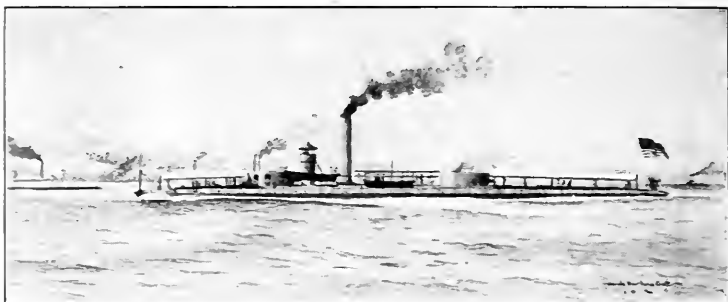

THE CHICKASAW, TYPE OF IRON-CLAD USED ON THE MISSISSIPPI RIVER

ing in Mexico, began to be shaken wide awake by what was to be done, and the responsibility which lay upon him to do it. It was he who, in the early autumn of 1861 (September 4th and September 6th), occupied Cairo and Paducah, the keys to the rivers at his front. The one lay at the junction of the Ohio and the Mississippi, the other at the junction of the Ohio and the Tennessee. From Cairo the Mississippi flowed down to the Gulf through the very heart of the Confederacy; at Paducah the Tennessee found its outlet, coming all the long way round about Tennessee out of the northern counties of Alabama; and near at hand, scarcely ten miles away, came down the Cumberland from its six hundred mile journey through Kentucky and northern Tennessee.

In February, 1862, the movement of the federal troops southward began, up the valleys of the rivers, under General Pope, General Buell, General Thomas, and General Grant, supported at each advance by gunboats on the rivers, and by midsummer a great wedge of armed men and boats had been driven into the confederate territory. General Grant, supported by a

ARMED DIVISION

fleet of gunboats under Commodore Foote, moved up the Tennessee River and took Fort Henry on February 6th; and on the 16th crossed to the Cumberland and took Fort Donelson. Following his movement, a force under General Pope, similarly supported by an armed flotilla, with infinite difficulty cleared the Mississippi of the confederate blockades at New Madrid and Island Number Ten, lying like outposts at the northern boundary lines of Arkansas and Tennessee.

General Grant, with that grim thoroughness which all men presently saw in him when once he was afoot, pressed forward, beyond the forts on the Tennessee and the Cumberland, to strike at Corinth, a railway centre in northern Mississippi. It was his principle to be moving always, forcing the fighting. He knew the men against whom he acted, he thought; most of them had been his comrades in Mexico. He thought he knew what mistakes they would make. But they

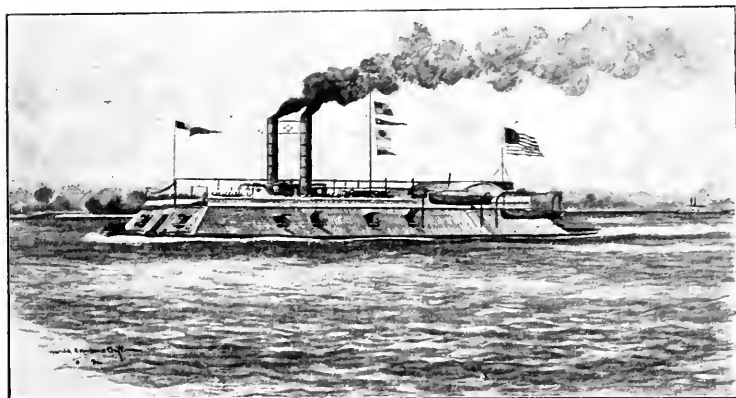

THE DE KALB, TYPE OF IRON-CLAD USED ON THE MISSISSIPPI RIVER

checked him very sharply whenever he blundered or exposed himself without force enough to crush them. On a Sunday morning, the 6th of April, a confederate force under General Albert Sidney Johnston fell upon his regiments by Shiloh church with an onset which could not be withstood, and only the confusion of their rushing victory and a steadfast regiment here and there to stem the tide saved his force from being caught in a corner between river and creek, his base at Pittsburgh Landing from being taken. But Johnston had been mortally wounded. A wound had severed an artery; he had ignored it and led a desperate charge in person; and had gone from the field to die. The next day brought Grant reinforcements which gave him commanding numbers, and he moved forward again, forcing General Beauregard, now in command in Johnston's stead, to retire before him. The federal army advanced upon Corinth at its leisure, one hundred thousand strong, under General Halleck, commander-in-chief in the West. A slow siege was drawn about the place, and on the 30th of May, when everything was ready for the final assault, Beauregard abandoned it, deeming it untenable. The abandonment of Corinth, added to the possession of the forts on the Tennessee and the Cumberland, gave the federal commanders control of the railways which led to Memphis on the river upon either flank, and it became impracticable for the confederate forces to hold the Mississippi anywhere above Vicksburg. On June 5th Fort Pillow was abandoned; and on the 6th the federal gunboats, by desperate fighting, broke the defences of Memphis. The river was open down to Vicksburg.

Meanwhile, a fleet operating from the sea below had

ARMED DIVISION

gained control of the lower reaches of the river also, and Vicksburg was accessible by the federal forces from the south. On the 18th of April Commodore Far-



P. G. Beauregard

PIERRE GUSTAVE TOUTANT BEAUREGARD

ragut, who, as spring approached, had been sent to the Gulf to see what could be done to render the blockade effective at New Orleans, had opened fire on the forts which guarded the main outlets of the river. His fire proving of slow effect, he determined to attempt the

passage of the river without taking them, and on the 24th ran past them. The next day he took possession of the city, which had been evacuated upon his approach. The forts, thus isolated, were given up, and General Butler was put in possession of New Orleans, with the troops which had been waiting, ineffective till Farragut came, on Ship Island. When the year was out the confederate power touched the Mississippi nowhere but at Port Hudson and at Vicksburg, standing high upon its bluffs, a tangle of marsh and stream drawn about it everywhere but at the south and east, where the confederate armies were most easily handled to maintain it. Grant, still striking southward, attempted the formidable place before the year closed, seconded by General Sherman moving south from Memphis on the river. Each struck in turn; but each failed. The place remained to be taken.

In the East, meanwhile, in Virginia, where the fighting beat back and forth between the two capitals, fortune showed another face. There the federal commanders were outgeneralled and beaten. All the winter through, since the first fighting at Manassas, General McClellan, fresh from his successes in West Virginia, had been making ready an "Army of the Potomac" to move against the confederate capital. When spring came he showed himself in force on the old battle ground of the Revolution, taking his troops by water to Fortress Monroe and striking thence, against Joseph E. Johnston, up the peninsula which lay between the York and the James rivers. By dint of a month's siege he took Yorktown (May 4th). Following Johnston's retreat, he attacked him at Williamsburg and sought to prevent his crossing the Chickahominy, but could not. John-

ARMED DIVISION

ston, in his turn, himself across the river, attacked a part of McClellan's force which had crossed at Fair Oaks, before the rest could cross to their assistance, and two days' hard fighting barely saved the federal commander a disastrous loss. General Johnston having been wounded in the conflict, General Robert E. Lee took his place, a man whose quality of genius the Army of the Potomac was to learn until it had had its fill.

At 7 1/2 P. M. 30 May '64

Genl I J Beauregard
Hancock's House -

If you cannot determine what troops you
can spare the Left cannot - The result ~~will~~
~~be disaster~~ of your delay will be disaster -
Bitters troops will be with Grant tomorrow

27/340 Cyp

R E Lee

A CALL FOR REINFORCEMENTS

He was son to famous Lighthorse Harry Lee of the old days of the Revolution, but showed little of the dashing soldier in his person and bearing. He showed, rather, the modesty and unaffected gentle breeding of the old southern training; seemed never to stand for show but always for quiet principle, making those who dealt with him feel that he was a Christian as well as a gentleman, and felt the compulsion of nothing so much as the dictates of duty and honor. But, for all he was so simple and modest, he handled men under arms

in such fashion as presently made him the foremost soldier of his time. He was already distinguished. Since a lad he had served in the armies of the United States, loving the Union and serving it in the spirit he had taken from his father. The men who had served with him knew his genius; Mr. Lincoln had offered him the command of the army which was to act against the South. But he had declined the command, and, seeing how all things were turning in the home of his youth, had exchanged his federal commission for one held of Virginia for the coming struggle. He did not believe in secession; he utterly rejected the view of the constitution which so many of his neighbors had taken from Mr. Calhoun; it was revolution, in his view, nothing less, to break away from the government Washington and Madison and Hamilton had set up: they would have constructed no such rope of sand as the politicians about him told him it was meant to be. But he was of the breeding of the South: the breeding men in the North found it so hard to comprehend. Virginia was his home; there all his love and allegiance had their intimate rootage. If she seceded he must go with her; if armies were sent against her he must defend her. He explained it so, very frankly, before Virginia had acted, to General Blair, who brought him Mr. Lincoln's offer of the command of an army of attack. "I told him," he said, "as candidly and courteously as I could, that though opposed to secession and deprecating war, I could take no part in *an invasion of the Southern States.*" It was this quiet man, of clear principle, with a sentiment for his own people which was for him a thing as strong and imperative as principle, who now found himself in chief command against the army he might have led.

ARMED DIVISION

McClellan had expected to be joined by reinforcements under General McDowell; but the military genius of another confederate commander prevented that.



George Brinton McClellan

GEORGE BRINTON
MCLELLAN

Thomas J. Jackson had shown his quality in part at Manassas. There he had held his men unshaken against charge after charge of the federal regiments, and had been dubbed "Stonewall" Jackson from that

day. Now he showed gifts of another kind. He was oddly compounded of Covenanter and strategist; showed in all things a steadfastness, a stiffness of character and principle which seemed strangely contrasted with the audacity and sudden dash with which he moved when in the field. In fact the two things were united with singular harmony in the man: the iron character and the instant purpose: the will that operated like an impulse but which achieved its end with the precision of a thing calculated and long foreseen,—the almost instinctive energy of a mind that never doubted or turned aside. Hard-set principle and bold initiative were things to be looked for in combination in men of his Scots-Irish blood. By a series of sudden marches and surprises such as his opponents presently learned to expect but could never foresee or make themselves safe against, he cleared the Shenandoah valley of federal troops, seemed to threaten Washington itself, and kept McDowell where he was, to guard the seat of government. Then, as suddenly, he turned about and carried his forces by rail to General Lee, to assist against McClellan. For seven memorable days the two beat McClellan's army back until Richmond was safe and the federal forces once more on their farther base at the James.

Mr. Lincoln tried a change of commanders. General McClellan was removed, and General Pope was brought, fresh from his exploits on the Mississippi at New Madrid and Island Number Ten, to take his place. The theatre of operations was shifted northward to the courses of the Rappahannock, that the full bulk of the federal armies might be interposed between General Jackson and the city of Washington. But Pope fared worse than

ARMED DIVISION

McClellan. By a forced march through the mountains, Jackson turned his flank and defeated General Banks at the western end of his line at Cedar Mountain (August 9th). On the 29th of August Pope's own command was attacked at Grovetown, and the next day routed at Manassas, by Lee and Jackson combined. A confederate force despatched westward on the federal flank captured Harper's Ferry, with its arsenal and its supplies and eleven thousand federal troops; and Lee crossed the upper Potomac into Maryland and confronted his opponents once more, at Antietam. There, on the 17th of September, battle was joined again, McClellan once more in command,—but without decisive result. Lee was checked and foiled, that was all. He found himself obliged, nevertheless, to recross the Potomac and withdraw towards his base of operations.

The success was not enough to satisfy the authorities at Washington. Once more they took the command of the unhappy Army of the Potomac from McClellan, to bestow it, by way of further experiment, upon General Burnside, who immediately proved himself the wrong man for the task. On the 13th of December he threw himself upon the confederate forces intrenched on Fredericksburg Heights, and was repulsed with great loss. It was the last action in the East until spring should come again. The federal commanders could show no progress made in that quarter.

Opinion shifted uneasily, the while, the nation through. The unexpected scope and magnitude of the war, its slow and sullen movement, its anxious strain of varying fortune, its manifest upheaval of the very foundations of the government, turned men's hopes and fears now this way now that, threw their judgments



Millard Fillmore

MILLARD FILLMORE

all abroad, brought panic gusts of disquietude and dismay which lasted a long season through before any steady winds of purpose found their breath and their settled quarter. For eighteen months Mr. Lincoln had waited upon opinion, with a patience which deeply irritated all who wished radical action taken. He knew the hazards of the time as well as any man: feared that at almost any moment news might come of the recognition of the southern Confederacy by the old governments abroad; knew how important success was to hold opinion at home no less than to check interference from without; was keenly conscious how the failures of the Army of the Potomac offset and neutralized the successes of the federal arms in the West; and realized to the full how awkward it was, whether for the government of opinion at home or over sea, to have no policy more handsome than that of conquest and subjugation. It was necessary to put the South at a moral disadvantage by transforming the contest from a war waged against States fighting for their independence into a war against States fighting for the maintenance and extension of slavery, by making some open move for emancipation as the real motive of the struggle. Once make the war a struggle against slavery, and the world, it might be hoped, would see it a moral war, not a political; and the sympathy of nations would begin to run for the North, not for the South. But Mr. Lincoln knew also that the thoughts of the people changed more slowly than the thoughts of politicians; that the mass of men, who must fill the ranks of the armies and vote at the polls in the elections, quitted their old ways of thinking stiffly and with reluctance. He waited for their purpose to harden. He had come into office declaring that the party he led

had no intention whatever to molest slavery in the States which had already established it; and he knew that he must wait for the people at his back to change their temper under the strain of the fighting before he openly turned about to accept a revolution and seek emancipation as the object of the war.

By midsummer, 1862, he was convinced that opinion was ready. He waited only for some show of victory by the Army of the Potomac to put the new, aggressive policy he contemplated in countenance. The check given Lee at Antietam served the purpose, in lieu of something better; and on the 22d of September he issued a proclamation which gave formal notice that unless the southern States returned within a hundred days to their allegiance to the Union he would declare the slaves within their limits free. On the 1st of January, 1863, accordingly, he put forth a definitive proclamation of emancipation. It was an act which bound no one except commanders in the field. The President had no authority to alter or abolish the laws of the southern States, in open secession though they were. He could do nothing more in actual execution of the proclamation than command federal officers in the field to set free the negroes who fell into their hands, and keep their freedom secure within the territory actually occupied or controlled by their troops. That he could do as an act of war, under his authority as commander-in-chief. Some of the federal commanders had already ventured to set the negroes free in the districts they occupied, but Mr. Lincoln had rebuked them and annulled their acts till he should be ready. The proclamation, when it came, was no law, but only his deliberate declaration of policy, for himself and for his party; and

ARMED DIVISION

changed, as he had meant that it should change, the whole air of the struggle, and of politics as well.

For a moment opinion seemed to swing back, as if he had gone too far and too fast. The autumn elections, which followed the preliminary proclamation of September, showed in some quarters a marked uneasiness that he should have made so sharp a revolution in the avowed purposes of the party and the government he led; and a



FACSIMILE OF WAR SCRIP ISSUED BY THE CONFEDERATE LEGISLATURE OF MISSOURI

number of Republicans in the less steadfast constituencies lost their seats in the House of Representatives to Democrats. But opinion set steadily forward again with the President before the winter was out, and the reverses of the autumn elections did not slacken the action of Congress or daunt its leaders. Their radical measures matched with what they believed to be the real temper of the country in the face of a crisis which seemed to increase in magnitude and gravity with every campaign of the contending armies. In December, 1862, they did not hesitate to sanction the division of

Virginia into two distinct States by admitting the western counties of Virginia to representation in Congress as the State of West Virginia. The forty western counties of the Old Dominion, which lay beyond the Blue Ridge, had not sympathized with secession or a war for the maintenance of slavery. Northern troops under McClellan had got control of them at the very outset of hostilities, because of the friendliness of their people and the weak hold of the confederate commanders upon the region. The antagonisms between the people of the eastern and western counties,—the people beyond the mountains and the people within the Shenandoah valley and by tide-water,—were an old story. The mountains separated them in commercial interest; life ran differently on the one side and the other; the settlers beyond the mountains said that too little heed was paid to their affairs at Richmond,—or too much, by way of restriction. When the State went out of the Union, therefore, they deemed it a good time to make their separate interests known. A revolutionary state government was established, for which they asked admission into the Union. The constitution of the United States forbade the division of any State without its own consent, but the Republican leaders in Congress were ready to accept the theory that the provisional government set up in western Virginia, inasmuch as it was loyal to the Union, was the only legitimate government of Virginia, and could itself authorize the division of the State. West Virginia was, accordingly, in due form admitted to the Union,—without too curious an examination of the constitutional law of the case.

The houses were in a radical temper. In March, 1863, the President was authorized to suspend the opera-

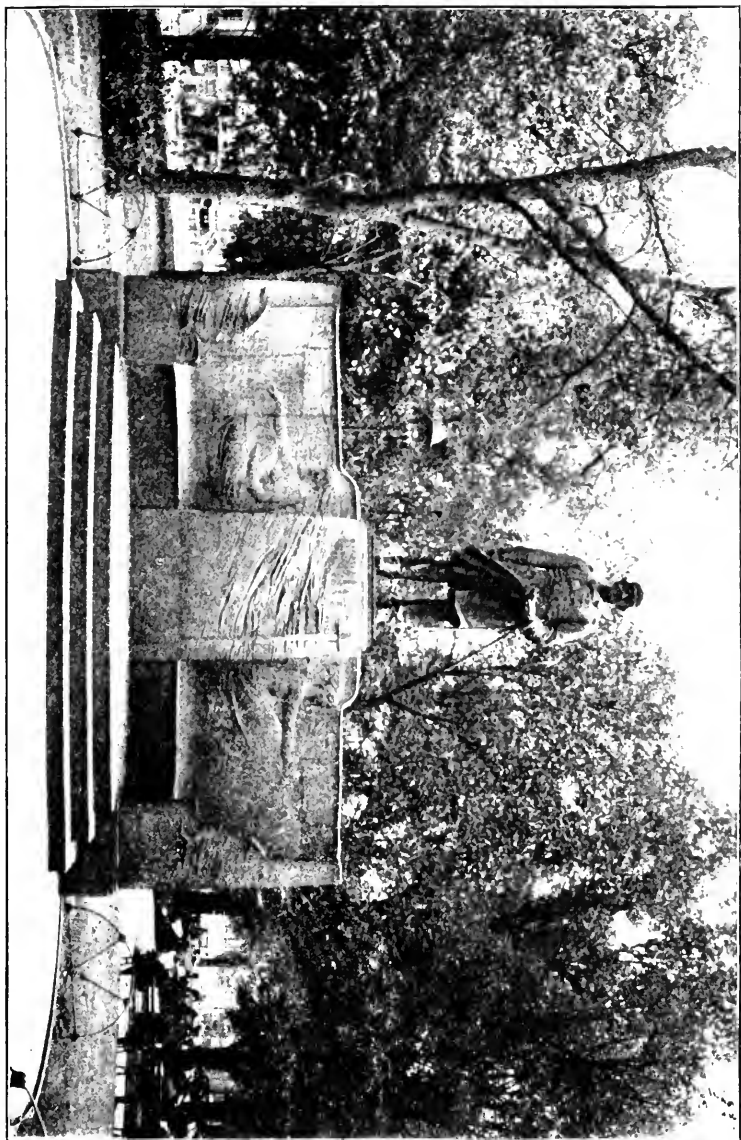

STATUE OF FARRAGUT IN MADISON SQUARE, NEW YORK CITY

tion of the writ of *habeas corpus* in cases of persons suspected of disaffection towards the United States; and a Draft Act became law which substituted compulsory for voluntary military service upon a scale which showed a new system and purpose in the prosecution of the war. The operation of the writ of *habeas corpus* had already been frequently suspended. Mr. Lincoln had not hesitated since his first call for volunteers in April, 1861, to proclaim martial law wherever it seemed to him necessary or serviceable to proclaim it. Congress now gave him explicit authority to set aside the rights of individuals wherever it seemed necessary to do so in order to safeguard the Union. The Draft Act meant that Congress realized at last the magnitude and the almost desperate difficulty of the war it had embarked upon. In carrying it into execution the government learned something more of the temper of the people. Intense excitement everywhere accompanied the progress of the conscription. In some places it was forcibly resisted, not so much because of the deep unpopularity of the thing itself as because it seemed to be enforced with gross partisan partiality. Democratic counties, it began in some parts of the country to appear, were much more heavily drawn upon than those whose votes had been cast in the elections for the party in power. The excitement culminated more sharply and ominously in New York than anywhere else; and in the city of New York very serious outbreaks occurred,—savage “draft riots” which were to linger in the recollection many a long year like an ugly nightmare. For four whole days of that memorable summer (July 13–16, 1863) the town was practically at the mercy of mobs which surged in its streets almost at will, and defied the

government to put the obnoxious act into execution. It was executed, none the less, in the end. Inequalities in its enforcement as between locality and locality were corrected, but its essential rigor was not abated.

If the war was to be successfully prosecuted, there must be created, as Congress and the President saw, not only vast armies, but also huge fleets to close the southern ports. When Mr. Lincoln proclaimed the southern ports blockaded, in April, 1861, there were but forty-two vessels of war in commission. The southern coasts were full three thousand miles long. So early as August, 1861, Fort Hatteras, in North Carolina, had been taken by a federal force, and early in November Port Royal in South Carolina; Fortress Monroe, within the capes of the Chesapeake, remained in possession of the federal authorities from the first, and federal fleets could lie in Hampton Roads; Key West, in the Florida Keys, and Fort Pickens, by Pensacola, within the Gulf, had not fallen into the hands of the Confederacy; but nowhere else on the long reaches of the interminable coast was there any other harbor of refuge or rendezvous for the scant blockading force, until Fort Pulaski, which guarded the approaches to Savannah, was taken (April, 1862) and Farragut occupied New Orleans, at the spreading mouths of the Mississippi. For a little while the southerners had seemed quicker than the North in putting their power on the sea. Early in 1862 they sent out of Norfolk against the fleet which lay in Hampton Roads an iron-clad ram, improvised out of a sunken frigate, which for a memorable twenty-four hours seemed likely to sweep the whole anchorage of its transports and men-of-war. Only the timely arrival of an armored craft of another pattern out of New York saved the

fleet from annihilation. The confederates had given their ram, the *Virginia*, sides which sloped like a roof, and had cased them in railway iron. The strange



J. Ericsson

JOHN ERICSSON

craft brought from New York to meet her had been devised by John Ericsson, a Swedish engineer who had sought his fortune in England at twenty-three and come to America at thirty-six (1839); the man who, more than any other, had made the use of the screw

ARMED DIVISION

propeller practicable in navigation. The low, flat body of his *Monitor* rose but a foot or two above the level of the water. She carried her battery within an iron martello tower so constructed as to revolve, as if upon a pivot, so that her fire might be delivered in any direction. On the 9th of March the two novel craft made trial of each other, and the *Virginia* was worsted. Her shot made no impression on the turret in which the



THE MONITOR

Monitor carried her guns or on the iron-sheathed deck about it, and the low iron hull of her antagonist afforded no target.

A new age of naval construction began the day of that extraordinary duel. Henceforth, as the world saw, vessels of war must be built and clad with iron upon the principles taught by John Ericsson and the confederate naval constructors at the Norfolk navy yard. But the revolution could not be wrought in a moment. The federal authorities promptly made plans to construct some sixty vessels of the *Monitor* type; but they bought and built craft of every other sort, the while, to make good their investment of the long coast. Before the close of 1861 two hundred and twenty-six vessels were in commission; one hundred

and sixty-three were added in 1862, one hundred and sixty-one in 1863,—over and above all lost, captured, wrecked, or burned:—steamers armored and unarmored, side-wheel and screw; sailing vessels great and small; craft of any kind that could carry guns or be made in any way to serve in the difficult blockade. Confederate privateers and cruisers, fitted out for the most part in foreign ports, stole in and out of the blockaded harbors and ranged the seas with a singular audacity, like the revolutionary craft of the old days of the war for Independence; captured merchantmen almost at will, until the losses they inflicted counted up into the millions; almost swept the sea for a time of all commerce under the federal flag. But one by one they were trapped and taken. Even fleet-footed steamers presently found it impossible to run the blockade of the southern ports. The coast lights were out; the blockading fleets lay with no sign set the night through. The best pilots in the southern waters were likely to throw their craft away by a rush in the dark; and in the daytime it was madness to attempt the passage amidst the crowding men-of-war.

A third year of fighting brought no radical change of fortune in the fields where the armies moved. Still the federal commanders stormed their way southward in the West; still they were beaten and foiled in Virginia. After Fredericksburg, General Hooker had taken Burnside's place in command of the Army of the Potomac; and Hooker in his turn had made a movement upon Richmond. On the second and third days of May, 1863, he tried conclusions with Lee and Jackson at Chancellorsville, and was utterly defeated. But the fighting, though it gave them victory, cost the confederates the

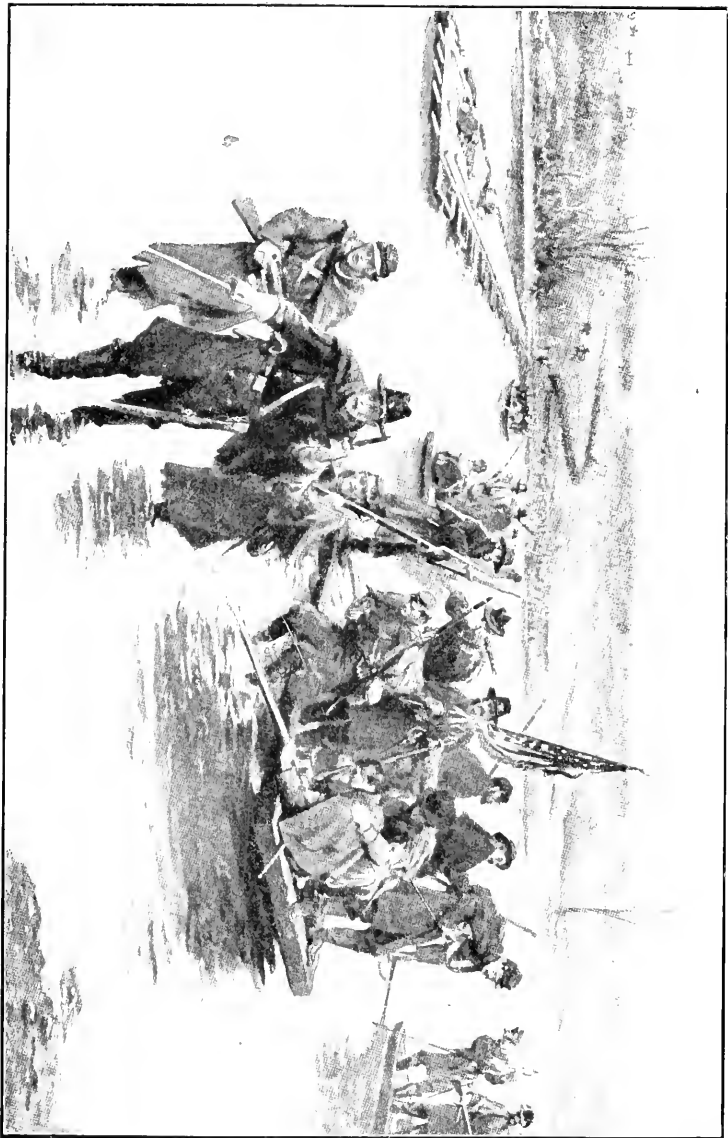

BATTLE OF FREDERICKSBURG. VOLUNTEERS CROSSING THE RIVER

life of Stonewall Jackson. He was shot, by tragical mistake, by his own pickets, as he returned from a reconnaissance. The loss was as irreparable as the loss of Albert Sidney Johnston at Shiloh church. They could have spared an army better than either of these men of genius.

Following up his advantage, Lee moved forward into Pennsylvania, upon the aggressive; met Meade at Gettysburg; and was repulsed, with heavy loss. He threw his men across long open spaces against the federal troops strongly posted and intrenched. For three days, the first three days of July, he beat doggedly upon them. The second day he drove their lines partly in and took a part of their position; but the third day the lost ground was recovered and he was driven back, his army almost decimated, to seek his base again in Virginia. Had he succeeded, no man can say what radical sweep of reaction there might have been at the North, in the face of his successful invasion, or what decisive advantage he might have won. But he failed; and the tide of war seemed to all the nation to turn.

Almost on that very day, moreover, Vicksburg yielded to the siege of General Grant. The defence of the place had been stubborn, prolonged, heroic, almost successful. Every plan of direct attack had failed. General Grant found it necessary to sweep round about the town upon every side, clear the country back of it of troops and all means of succor, and take Jackson, the capital of the State, forty miles away, in order to command all approaches. He sat down at last in patient siege, and forced the garrison of the place to surrender to him, half starved, on the 4th of July. On the 9th Port Hudson, below, yielded to the same necessity and was

ARMED DIVISION

surrendered to General Banks. The Confederacy was broken in half. Louisiana and Texas were cut off. Throughout its entire length the Mississippi was in the hands of the federal power.

Grant turned from his hard-earned success at Vicksburg to take charge of the federal army shut up in Chattanooga. Upon the evacuation of Corinth, Mississippi, in May of the preceding year, General Braxton Bragg had taken thirty-five thousand confederate troops east to Chattanooga, and had struck northward thence into Kentucky. But General Buell had met him in a decisive action at Perryville, October 8, 1862, and had compelled him to retire again to his base. General Van Dorn, meanwhile, had sought to take Corinth again, and had given General Rosecrans two days of desperate fighting to prevent it (October 3-4, 1862). Finding it impossible to extend their operations, the confederate commanders drew back upon the central strongholds of Tennessee and Georgia. Just as the year 1862 passed away and the year 1863 came in (December 31st to January 2d) Rosecrans and Bragg grappled in three days' desperate fighting around Murfreesboro. Bragg attacked with a spirit, dash, and stubborn ardor which no troops but troops of the same race with his own could have withstood; but Rosecrans' men held their ground, or, having lost it, regained it, and Bragg withdrew. The new year saw him forced back step by step, the summer through, by the successful movements of the federal forces at his front, until autumn came and even Chattanooga had to be abandoned. Then (September 19 and 20, 1863) he made final stand against Rosecrans at Chickamauga and inflicted upon him a defeat which nothing but the extraordinary cool-

By the President of the United States of America:
A Proclamation.

Whereas, on the twenty-second day of September, in the year of our Lord one thousand eight hundred and sixty-two, a proclamation was issued by the President of the United States, containing, among other things, the following, to-wit:

That on the first day of January, in the year of our Lord one thousand eight hundred and sixty-three, all persons held as slaves within any State or designated part of a State, the people whereof shall then be in rebellion against the United States, shall be then, thenceforward, and forever free; and the Executive Government of the United States, including the military and naval authority thereof, will recognize and maintain the freedom of such persons, and will do no act or acts to oppress such persons, or any of them, in any efforts they may make for their actual freedom.

That the Executive will, on the first day of January aforesaid, by proclamation, designate the States and parts of States, if any, in which the people thereof, respectively, shall then be in rebellion against the United States, and the fact that any State, or the people thereof, shall on that day be, in good faith, represented in the Congress of the United States by members chosen thereto at elections wherein a majority of the qualified voters of such State shall have participated, shall, in the absence of strong countervailing testimony, be deemed conclusive evidence that such State, and the people thereof, are not then in rebellion against the United States.

Now, therefore I, Abraham Lincoln, President of the United States, by virtue of the power in me vested as Commander-in-Chief, of the Army and Navy of the United States, in terms of actual armed rebellion against authority and government of the United States, and as a fit and necessary war measure for suppressing said rebellion, do, on this first day of January, in the year of our Lord one thousand eight hundred and sixty-three, and in accordance with my purpose so to do, ^{publicly} proclaim for the full period of one hundred days, from the day first above mentioned, order and designate

as the States and parts of States wherein the people thereof respectively, are this day in rebellion against the United States, the following, to-wit:

Arkansas, Texas, Louisiana, (except the Parishes of St. Bernard, Plaquemine, Jefferson, St. John, St. Charles, St. James Arcens, Assumption, Terrebonne, Lafourche, St. Mary, St. Martin, and Orleans, including the City of New Orleans) Mississippi, Alabama, Florida, Georgia, South Carolina, North Carolina, and Virginia, (except the fortyeight counties designated as West Virginia, and also the counties of Berkeley, Accomac, Northampton, Elizabeth City, York, Princess Anne, and Norfolk, where the City of Norfolk is situated; and which excepted parts are, for the present, left precisely as if this Proclamation were not issued.

And by virtue of the power, and for the purpose aforesaid, I do order and declare that all persons held as slaves within said designated States and parts of States, are, and henceforward shall be free; and that the Executive Government of the United States, including the Military and Naval Authorities thereof, will recognize and maintain the freedom of said persons.

And I hereby enjoin upon the people so declared to be free to abstain from all violence, unless in necessary self-defense; and I recommend to them that in all cases when allowed, they labor faithfully for reasonable wages.

And I further declare and make known, that such persons of suitable conditions, will be received into the armed service of the United States to garrison forts, positions, stations and other places, and to man vessels of all sorts in forward service.

And upon this act, sincerely believed to be an act of justice, warranted by the Constitution, upon military necessity, I invoke the consideration and judgment of mankind, and the gracious favor of Almighty God.

In witness whereof, I have hereunto set my hand and caused the seal of the United States to be affixed.

Done at the city of Washington, this first-day of
January, in the year of our Lord one thousand
eight hundred and sixty three, and of the

 Independence of the United States
of America the eighty-seventh.

Abraham Lincoln

By the President;
William H. Seward,
Secretary of State

ness and firmness of General Thomas, who commanded the left federal wing, prevented from becoming the most overwhelming federal disaster of the war.

Bragg advanced, shut Rosecrans up in Chattanooga, and drew his force about the place to take it. General Grant came from Vicksburg to save it. The town lay with a sweeping amphitheatre of hills about it. Upon these coigns of vantage General Bragg had disposed his army: at the one end of the long semicircle abrupt Lookout Mountain, at the other steep Missionary Ridge, both alike, it might well seem, impossible of assault. Grant attempted and took them, nevertheless (November 24th and 25th). Sherman was sent to take Missionary Ridge, Hooker to take Lookout Mountain: the four greatest commanders of the northern armies directed the battle or moved upon the field,—Grant, Thomas, Sherman, Sheridan. Their men circled and climbed the steep ridges of the hills in a drifting fog; regiments of volunteers threw themselves with splendid recklessness upon the centre of Bragg's position, to hold him off from concentrating his force against Sherman on his left, and, before they could be stopped, took the heights where his guns were. The siege was raised; the confederate army fell back on Dalton. Grant had attacked when Bragg was weakened by the absence of a part of his force sent under Longstreet to meet Burnside in eastern Tennessee. Missionary Ridge and Lookout Mountain being lost, and Bragg dislodged, Longstreet did not return, but crossed the mountains and joined Lee in Virginia.

Then came the winter's pause of arms. No man who looked about him could fail to see that, despite Lee's victorious movement in the East against the

Army of the Potomac, the whole aspect of the war had changed. A girdle of arms had been drawn about the South, and her means alike of aggression and of defence were being slowly choked within her. On the one side of her were armies which grew with every campaign, while her own diminished; on the other, increasing fleets which closed every port from Hampton Roads to Galveston. Though it had taken two years to build and muster ships enough to make the blockade a thing of fact, it was now at last a stern reality. The South knew herself face to face with bankruptcy. Her exports were her only source of wealth; only her cotton could command the money of the world; and her cotton was locked useless within her ports. With closed ports she was ruined. A successful blockade runner here and there could bring no compensation for her throttled trade.

Her levies, too, drew, not upon an increasing, but upon a diminishing population. The confederate government resorted to draft acts, as the government at Washington did, when volunteers lagged or were not to be had; but it had no such population to draw upon. There were but five and a half million white people in all the seceded States when the war came; in the North twenty-two millions. As the southern armies grew, business offices, courts, counting houses, plantations were emptied, and only women and boys were left to direct the work which was to sustain the government and feed the armies. The federal government, knowing its advantage, refused to exchange prisoners; and for every man lost or taken the South had to find another from its thinning ranks for the fighting line.

It was a singular and noteworthy thing, the while,

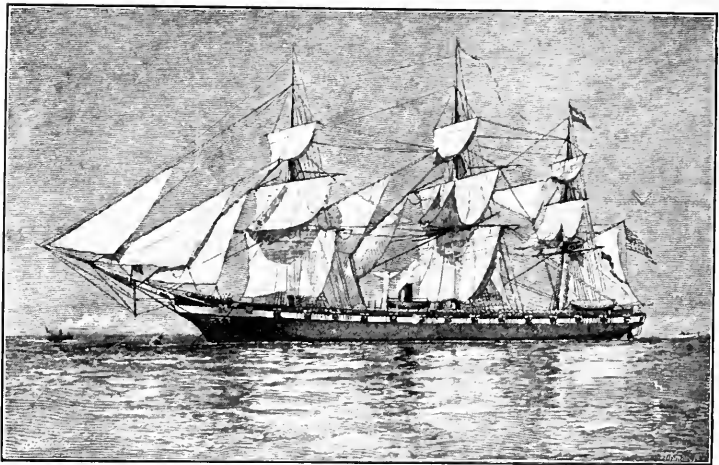

THE HARTFORD, FARRAGUT'S FLAG-SHIP

how little the quiet labor of the negroes was disturbed by the troubles of the time and the absence of their masters. No rumor of the emancipation proclamation seemed to reach the southern country-sides. No sign of the revolution that was at hand showed itself upon the surface of southern life. Gentlewomen presided still with unquestioned authority upon the secluded plantations,—their husbands, brothers, sons, men and youths alike, gone to the front. Great gangs of cheery negroes worked in the fields, planted and reaped and garnered and did their lonely mistresses' bidding in all things without restlessness, with quiet industry, with show of faithful affection even. No distemper touched them; no breath of violence or revolt stirred amongst them. There was, it seemed, no wrong they fretted under or wished to see righted. The smiling fields not yet trodden by the feet of armies still produced their

golden harvests of grain under the hands of the willing slaves, and the armies were fed.

But the quiet tillage of her fields was all that remained of the old life of the South. Her trade was dead for lack of markets; her business offices were empty; the flower of her population was drawn into her armies; her resources were sapped and could not be renewed. The North, on the contrary, increased in wealth and population alike the long struggle through, despite the hundreds of millions poured out in money and the hundreds of thousands of men sent to the slaughter of the field of battle. In the South there was presently nothing to tax, and the confederate government was at its wits' ends where to get money. In the North taxes yielded whatever Congress demanded. New direct taxes were imposed; still heavier duties were laid on imports; and, though many grumbled, all paid, and most were abundantly able to pay; for trade and industry were not checked.

Congress even succeeded at last in devising a banking system which should relieve the strain upon the Treasury and at the same time serve the business interests of the country,—a system which solved the difficulties which had stood unsolved ever since General Jackson destroyed the Bank of the United States and Mr. Van Buren set up the Independent Treasury. Twenty-five years before, New York had erected, in its “free banking” act of 1838, the model for the system which the federal government now tardily adopted. By that act New York had abandoned the old and vicious practice of granting special charters to individual banking companies, and had thrown banking privileges open to any group of responsible persons who would comply

with the requirements set forth in the new law. Chief among these requirements was the deposit of recognized securities with the state government by every bank of issue to the full value of its circulating notes, in order that their payment might in any case be made good. In an Act of February 25, 1863, Congress made provision for a similar system of national banks; and by an Act of June 4, 1864, perfected the system and put the new law on a permanent footing by a thorough revision. The Act created a new bureau of the Treasury, under a Comptroller of the Currency, to superintend and secure the enforcement of its provisions. The Comptroller was authorized to permit the free establishment, for a term of not more than twenty years, of banking associations consisting of not fewer than five persons and having a capital of not less than one hundred thousand dollars; and in small places associations having even a smaller capital. Such associations were required to deposit with the Treasury Department bonds of the United States of the value of at least one-third of their capital; in return for which there should be issued to them from the Treasury circulating notes representing an amount equal to ninety *per cent.* of the market value of their bonds, but never exceeding ninety *per cent.* of their par value. The total issue of currency to be made under the Act was limited to three hundred millions; and that amount, it was provided, should be apportioned among the States in proportion to their population and banking capital. The immediate object of the Act as a government measure was to create a market for the bonds of the United States and quicken the processes of borrowing upon which the government was in large part obliged to depend for the support of

ARMED DIVISION

the war. It served the convenience of the country, however, hardly less than it helped the government; and what was primarily intended as a measure of public finance became the prop of private business. An Act of the following year (March 3, 1865) put a tax of ten *per cent.* on the circulation of all state banks, and forced them, if they would continue banks of issue, to qualify under the federal law.

The fourth year of fighting was the last. The crush-

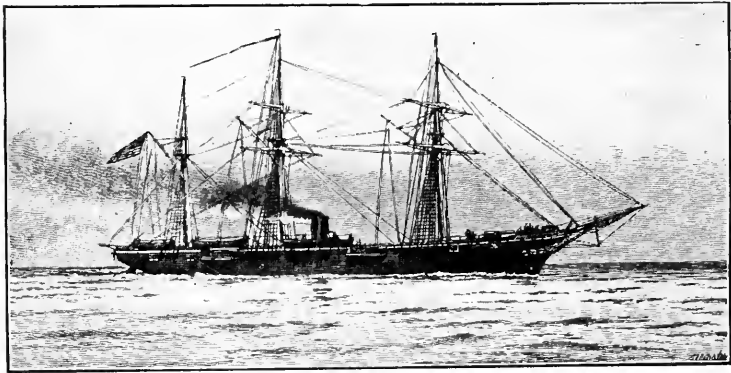

UNITED STATES SLOOP OF WAR KEARSARGE

ing weight of the North told more and more; and the South tottered to collapse. By the spring of 1864 the federal armies were ready for their final movements, the confederate armies freshened, recruited, posted as best they might be for their last stand and defence. The final reallocations of federal commanders had been made. General Grant had become commander-in-chief and had taken personal command of the Army of the Potomac against Lee. General Sherman, upon whom Grant had learned to depend at Vicksburg and Chattanooga, was in command in the West. In May, Grant,

with Meade, moved forward from the Potomac into the broad "Wilderness" of wood and thick undergrowth that stretched south of Fredericksburg and the Rappahannock to the York River, forcing Lee to make a slow retreat before him. The retreat was slow indeed. Lee operated upon shorter lines than his enemy, and behind intrenchments. He had scarcely seventy thousand men, and knew not where to get more; Grant had one hundred and twenty thousand, and could have as many more as he needed. By the first of November Grant had lost eighty thousand,—more than Lee had had to face him with at the outset; but his ranks were still full. Lee outplayed him in the great game of war, but could not stand before the ceaseless movement of his accumulating force. For sixteen days of almost continuous fighting he held Grant in hand, his slow withdrawal southward like the manœuvres of a long battle rather than like a retreat; and at the end, when he found a place to his mind, at Cold Harbor, on the 2d of June, made stand and repulsed the federal attack along his entire front.

But he was too heavily outnumbered. General Grant was not like the other men who had commanded the Army of the Potomac. No defeat stopped him or so much as gave breathing time. He filled his ranks and moved forward, whether in the face of victory or in the face of defeat, determined "to hammer continuously until by mere attrition," if in no other way, the stubborn army at his front should be worn to a weakness that must bring him his triumph. It became a mere question of who could stand the heaviest losses. Six thousand Union soldiers had fallen at Cold Harbor in a single hour; but their places were not long vacant.



W. T. Sherman

WILLIAM TECUMSEH SHERMAN

Flank movements, now upon this hand now upon that, rendered each position of Lee's army in turn untenable; and he was obliged at last to concentrate upon Petersburg and Richmond. There direct attack availed the federal commanders little. They were forced to sit down about Petersburg in a nine months' formal siege.

Meanwhile General Sherman had driven Johnston in like fashion, with like difficulty and stubborn fighting, back through northern Georgia upon Atlanta; and would have had infinite slow labor to the last had not Mr. Davis, displeased that Johnston did not beat the overwhelming army at his front, removed him from the confederate command,—the one man available who could make inferior numbers formidable against such an opponent,—and so made the task of the invading army easy. Johnston out of his way, Sherman cut Atlanta's communications to the southward, forced the evacuation of the place without serious difficulty, and, leaving Johnston's successor, General Hood, to face Thomas at the north, whither he was forced to turn, himself pushed on to the cities of the coast. At Franklin, Tennessee, November 30th, Hood threw himself, in his impetuous fashion, on Thomas's advance force of eighteen thousand men, and was checked. At Nashville, on the 15th of December, Thomas himself attacked, and so utterly routed him that his army was never again brought together as an effective force. Sherman, confident that Thomas could take care of Hood at his rear, moved steadily on to Savannah and took it (December). Before he left Savannah, Wilmington, North Carolina, and the formidable batteries at Fort Fisher had been taken by naval and military forces co-operating on the coast; and when he left Savannah

and advanced into Carolina his movement forced the evacuation of Charleston. Mobile had been taken by Farragut and land forces operating with him early in August. Not a port of consequence remained to the Confederacy; and the very fields that had fed the southern people were swept bare. Sherman's men had left little enough in their track. They had devoted themselves to destruction and the stripping of the land they crossed with a thoroughness and a care for details hardly to be matched in the annals of modern warfare. The old heats of civil war, dreaded since the world began, had been blown very hot as year was added to year in the bitter struggle, and each soldier played the marauder very heartily. What the South had not spent or war consumed he stripped her of as he could. What he did not need or want he destroyed.

By spring, as Sherman swept slowly northward through the Carolinas for a final junction with Grant in Virginia, the inevitable had been accepted, and the war was over. Lee had not had the strength to prevent the federal lines from being drawn completely around him. By the first days of April he had found Richmond untenable and had withdrawn towards Danville, hoping to effect a junction with Johnston, now once more in command of the decimated force that was facing Sherman coming north; but everywhere he was cut off, entangled, outnumbered; and on April 9th he sur-



TABLE USED AT THE SURRENDER
AT APPOMATTOX COURT HOUSE

rendered to General Grant at Appomattox Court House. On the 26th Johnston surrendered to Sherman; and the end had come. The most honorable terms were granted. Both men and officers were to be released on parole. They were to keep their horses, "because they would need them for the spring ploughing and



CHAIR USED AT THE SURRENDER
AT APPOMATTOX COURT HOUSE

farm work," General Grant said, in his simple fashion. The horses were not the property of the confederate government, the federal commander was surprised and touched to learn, but of the men who rode them,—like almost everything else they had or used. The final arrangements were made almost as if by a conference between friends, both commanders quieted and solemnized by thoughts of the great matter they were bringing to a close. Another course had

been pressed upon General Lee, by some of his own officers, and even suggested by the President of the Confederacy. It had been proposed that he should disperse his army, to gather it again in small fighting squads at every point of vantage and make the conquest of the South impossible through the quick and ceaseless operations of guerrilla bands moving broadcast over the whole face of the various country. But he had refused with a sort of solemn anger. "You must remember we are a Chris-

tian people," he said. "For us, as a Christian people, there is now but one course to pursue. We must accept the situation; these men must go home and plant a crop; and we must proceed to build up our country on a new basis." The way of duty was plain to him.

And then, at the end, when the terrible days were over and a healing time of peace at hand in which passion might run cool again and men remember their common ties of citizenship and fraternity, a deeply tragical thing happened, as if to fill the cup of sectional bitterness to the brim and mark forever the fatal distemper of civil strife. On the evening of the 14th of April, 1865, five days after General Lee's surrender at Appomattox, ere Johnston had yielded to Sherman, Mr. Lincoln was shot in his box at Ford's Theatre in Washington, and the next day lay dead. The assassin had been John Wilkes Booth, the distinguished actor, half crazed by blind enthusiasm and poignant regret for the lost southern cause.

Mr. Lincoln had but a short month before entered upon his second term as President. The election had been held while General Grant was drawing his lines closer and closer about Petersburg and Richmond, while Sherman was sweeping southward from Atlanta to the coast of Georgia, while the struggle culminated which the last election had brought on. Passion had stirred in it as in the contest of arms itself,—not the ordinary ardor of parties arrayed against one another by sharp differences of principle, but the deeply excited passion which days of revolution and supreme crisis must always breed. The war had not run its extraordinary course without touching the very government itself with revolution. The constitution had been framed

with no thought to provide for such days as these, when States were breaking away from the Union and the government was struggling for life itself; and with the unlooked for exigency had come unlooked for and ar-



JOHN WILKES BOOTH

bitrary acts of power. The whole authority of the nation had seemed of a sudden to be concentrated in the Executive, without restraint of law. Citizens suspected of sympathy with the southern Confederacy had been arrested and thrown into prison, deported even, upon orders which were no better than *lettres de*

cachet. Many an undoubted principle of the constitution had seemed as if for the time suspended, in order that the executive and military power might move supreme, to meet a supreme necessity. Mr. Lincoln had acted oftentimes with the authority almost of a dictator, and had permitted his Secretaries, particularly the Secretary of War, a license of power greater even than he would himself have used. Individual rights had seemed for a time suspended.

The men who knew the President and were near him saw no permanent danger in all this, for they knew the singular nature of the man, detected not a movement of personal ambition in his exercise of power, felt with what kindness of judgment and with what sober motives of public service he acted, and looked confidently to see all things restored as of course to their old poise and balance when the storm of war had passed. But men who were not near him could not so see him. Even politicians of his own party thought him unsafe. Many plain people everywhere thought him more,—thought him capable of hopelessly marring the government and permanently weakening the foundations of individual liberty in the very act of saving the Union from overthrow. Fortunately rank and file had caught the spirit of the war, and the spirit of the man. Moreover, in his own homely phrase, it was no time, as every thoughtful man perceived, to risk swapping horses in the midst of the stream; and he received the electoral votes of every State that took part in the election except New Jersey, Delaware, and Kentucky.

There had seemed for a brief while, nevertheless, not a little danger of his defeat, and he had been nominated for his second term by a convention not gathered from

the Republican ranks merely but made up to represent all men, of whatever party allegiance hitherto, who deemed him the nation's indispensable instrument and servant at that time of crisis. As a consequence of the composite make-up of the convention, Mr. Andrew Johnson, a Union man but a Democrat, of Tennessee, had been nominated for the Vice Presidency, as if to mark and emphasize the co-operation of groups and sections which the time had called forth. Mr. Lincoln's death made Mr. Johnson President. The first tasks of peace were to be hardly less difficult and perplexing than the tasks of war had been, and the party which had triumphed was left without executive leadership at their very threshold.

The chief *general authorities* for the years covered by this chapter are the fifth and sixth volumes of Schouler; the fourth volume of Bryant and Gay; Alexander Johnston's *History of American Politics* and articles in Lalor's *Cyclopaedia of Political Science, Political Economy, and United States History*, especially the articles *Secession, Dred Scott Case, Rebellion, and Confederate States*; Larned's *History for Ready Reference*; the second, third, and fourth volumes of James Ford Rhodes's *History of the United States from the Compromise of 1850*; the sixth and seventh volumes of von Holst's *Constitutional and Political History of the United States*; and Nicolay and Hay's *Abraham Lincoln: A History*.

Among *special treatises*, dealing with particular interests or aspects of the war and its policies, the following are important and representative of a vast number of books: Horace Greeley's *American Conflict*; Henry Wilson's *Rise and Fall of the Slave Power in America*; Edward A. Pollard's *Lost Cause*; Joseph Hodgson's *Cradle of the Confederacy*; Edward McPherson's *Political History of the Rebellion*; Frederick Law Olmsted's *Cotton Kingdom*; Jesse Macy's *Political Parties in the United States, 1846-1861*; William H. Seward's *Diplomatic History of the Civil War*; James M. Callahan's *The Diplomatic History of the Southern Confederacy*; John C. Ropes's *Story of the Civil War*; William A. Dunning's *Essays on the Civil War and Reconstruction*; James Spence's *The American Union*; H. C. Fletcher's *History of the*

ARMED DIVISION

American War; George Lunt's *Origin of the Late War*; Frederic Bancroft's *The Final Efforts at Compromise* in the sixth volume of the *Political Science Quarterly*; J. D. B. DeBow's *Industrial Resources of the Southern and Western States*; T. S. Goodwin's *Natural History of Secession*; Joel Parker's *Personal Liberty Laws*; Marion G. McDougall's *Fugitive Slaves*; Leverett W. Spring's *Kansas* and Nathaniel S. Shaler's *Kentucky* in the *American Commonwealth Series*; F. W. Taussig's *Tariff History of the United States*; and A. S. Bolles's *Financial History of the United States*.

Among the important *biographies*, whether for weight of narrative or for side aspects of the great struggle, are George Ticknor Curtis's *Life of James Buchanan*; John T. Morse's *Abraham Lincoln* in the *American Statesmen Series*; Henry J. Raymond's *Life of Lincoln*; F. W. Seward's *Seward at Washington*; Edward L. Pierce's *Memor and Letters of Charles Sumner*; Lyon G. Tyler's *Letters and Times of the Tylers*; Pleasant A. Stovall's *Life of Robert Toombs*; Charles Francis Adams, Jr.'s *Charles Francis Adams* in the *American Statesmen Series*; William P. Trent's *Life of W. G. Simms*; A. M. Williams's *Sam Houston and the War of Independence in Texas*; Susan D. Smedes's *Memorials of a Southern Planter*; Alfred T. Mahan's *David Farragut*; Henry A. White's *Robert E. Lee and the Southern Confederacy*; Robert M. Hughes's *General Johnston*; Frederic Bancroft's *Life of William H. Seward*; and Albert Bushnell Hart's *Salmon P. Chase* in the *American Statesmen Series*.

The *military history* of the war and the *discussion of slavery* which necessarily went along with it may be found set forth in Theodore A. Dodge's *Bird's-Eye View of Our Civil War*; Comte de Paris's *Military History of the Civil War in America*; John W. Draper's *History of the Civil War*; The Century Company's *Battles and Leaders of the Civil War*; Heros von Borcke's *Memoirs of the Confederate War for Independence*; Lieutenant Colonel G. F. R. Henderson's *Stonewall Jackson and the American Civil War*; Mary Tremain's *Slavery in the District of Columbia*, in the *Publications* of the Historical Seminary of the University of Nebraska; Richard Hildreth's *Despotism in America*; Samuel Seabury's *American Slavery Justified*; Robert L. Dabney's *Defence of Virginia and the South*; Thomas R. R. Cobb's *Inquiry into the Law of Slavery*; H. Sherman's *Slavery in the United States*; William H. Chambers's *American Slavery*; Daniel R. Goodwin's *Southern Slavery in its Present Aspects*; John Henry Hopkins's *Views of Slavery*; James Williams's *The South Vindicated*; A. T. Bledsoe's *Is Davis a Traitor?* John C. Hurd's *Law of Freedom and Bondage and Theory of Our National Existence*; and P. C. Centz's *Republic of Republics*.

A HISTORY OF THE AMERICAN PEOPLE

Some of the *sources* for the period may be found in *The Congressional Globe*, the official documents of the government, notably the *Official Records of the Rebellion*; the contemporary newspapers; *Appleton's Annual Cyclopaedia*, especially under the titles *Congress of the United States*, *Congress*, *Confederate*, *Confederate States*, *United States*, *Army*, and *Navy*; Horace Greeley's *History of the Great Rebellion*; Alexander H. Stephens's *Constitutional View of the War Between the States*; O. H. Brownson's *American Republic*; Thurlow Weed's *Autobiography*; G. T. Curtis's *Correspondence of John Lothrop Motley*; Hugh McCullough's *Men and Measures of Half a Century*; John Sherman's *Recollections of Forty Years in House, Senate, and Cabinet*; *The Sherman Letters*; Ben. Perley Poore's *Perley's Reminiscences*; Henry A. Wise's *Seven Decades of the Union*; S. S. Cox's *Three Decades of Federal Legislation*; J. H. Gilmer's *Southern Politics*; William H. Seward's *Autobiography*; James Buchanan's *Buchanan's Administration*; Frederick Law Olmsted's *Journey in the Seaboard Slave States*, *Texas Journey*, and *Back Country*; Hinton R. Helper's *The Impending Crisis*; Mrs. Coleman Chapman's *Life of John J. Crittenden*; E. D. Keyes's *Fifty Years' Observation of Men and Events*; L. E. Chittenden's *Reports and Debates of the Conference Convention*; the third volume of Alexander Johnston's *Representative American Orations*; George Cary Eggleston's *A Rebel's Recollections*; Reuben Davis's *Recollections of Mississippi and Mississippians*; Jones's *A Rebel War Clerk's Diary*; Ulysses S. Grant's *Personal Memoirs*; William T. Sherman's *Memoirs*; A. G. Riddle's *Recollections of War Time*; Dabney H. Maury's *Recollections of a Virginian in the Mexican, Indian, and Civil Wars*; Judith W. McGuire's *Diary of a Southern Refugee During the War*; Herndon's *Life of Lincoln*; L. E. Chittenden's *Recollections of Lincoln and His Administration*; James S. Pike's *First Blows of the Civil War*; A. T. Porter's *Led On Step by Step*; Jefferson Davis's *Rise and Fall of the Confederate Government*; Nehemiah Adams's *South Side View of Slavery*; William Harper's *The Pro-Slavery Argument*; the *Papers* of the Southern Historical Society; James Stuart's *Three Years in North America*; Frederick Douglass's *Life and Times, Written by Himself*; Solomon Northrop's *Twelve Years a Slave*; the case of *Dred Scott vs. Sanford*, reported in the 19th volume of Howard's Reports; and the case of *Texas vs. White*, the leading decision of the Supreme Court with regard to the right of secession, reported in 7th Wallace's Reports.

CHAPTER V

THE CONFEDERATE STATES

THE nation, shaken by those four never to be forgotten years of awful war, could not return to the thoughts or to the life that had gone before them. An old age had passed away, a new age had come in, with the sweep of that stupendous storm. Everything was touched with the change it had wrought. Nothing could be again as it had been. The national consciousness, disguised, uncertain, latent until that day of sudden rally and call to arms, had been cried wide awake by the voices of battle, and acted like a passion now in the conduct of affairs. All things took their hue and subtle transformation from it: the motives of politics, the whole theory of political action, the character of the government, the sentiment of duty, the very ethics of private conduct were altered as no half century of slow peace could have altered them.

The sheer cost, the unspeakable sacrifices of the desperate struggle, made ineffaceable record of themselves in the thoughts and purposes of people and politicians alike. What had been spent to fight the fight out passed calculation. It had cost the country more than seven hundred men for every day of all the four long years of campaign and battle: four hundred killed or mortally wounded on the field, the rest dead of disease,

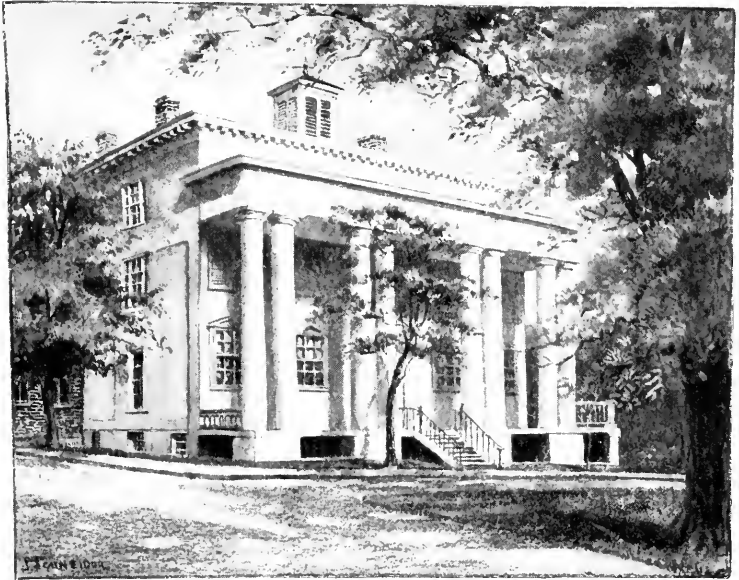

THE WHITE HOUSE OF THE CONFEDERACY, RICHMOND

exposure, accident, or the slow pains of imprisonment. The federal government had spent thirty-four hundred million dollars upon the war,—nearly two and a half millions for every day it had lasted; and less than eight hundred millions of that vast sum had come into its coffers from the taxes. More than twenty-six hundred millions had been added to the national debt. The Confederacy had piled up a debt, upon its part, of nearly fourteen hundred millions, and had spent, besides, no man could say how much; for the scant yield of the taxes had been supplemented by direct requisitions on the farmers for the food supplies of the armies; States had undertaken, so far as they could, to support their own volunteers in the field; private purses had been

opened to pay for the equipment of sons and brothers sent to the front, — every public and every private source had been drained.

In the North four men out of every nine of the military population had been enlisted for a service of three years in the field: in all 1,700,000 out of a military population of 4,600,000. Of these three hundred and sixty thousand had lost their lives; one hundred and ten thousand by the actual casualties of the field. But the sacrifices of the South had been greater yet,—immeasurably greater. The North had spent out of its abundance; the South had spent all that it had, and was stripped naked of its resources. While the war lasted it had been stripped naked also of its men. Nine men out of every ten of fighting age had gone from country-sides and towns to the field, reckoning only those who enlisted for at least three out of the four years of the struggle. Before the war ended mere half grown boys and men grown old were included in the muster. The total military population of the South was but 1,065,000. Nine hundred thousand of these she drew into her armies for at least three years of service. The lives of close upon three hundred thousand she gave as her sacrifice of blood,—more than one-fourth of all fit for the field. Ninety-four thousand lost their lives in actual battle. South Carolina lost one-fourth of her military population by the casualties of the field. The armed hosts and power of the North increased as the strength and resources of the South diminished. In 1861 the South had had 98,000 men in the field, the North 187,000; in March, 1865, though their levies had risen at the culmination of their effort but a little more than a year before to 471,000, the southern commanders had only

175,000 men to surrender to armies which aggregated 980,000 against them. The muster of federal forces increased even while the last scenes of war were being enacted and its tasks drawn to a close. When the surrender of the southern armies came they had grown by more than ten thousand, and there were 1,000,516 men awaiting their final discharge.

They were rapidly disbanded: sent home, when once peace was assured, at the rate of three hundred thousand a month. Only fifty thousand men were retained as a standing force. They turned to the duties of peace again and were absorbed into the mass of men whence they had come as quietly as if even civil war were but an episode in the long story of the national life. The common tasks of the communities to which they returned had gone forward, uninterrupted, without them; they returned merely to fill in the vacant places again and make complete once more the industries of their homes. The southerners, on the contrary, paroled at their surrender, and humanely bidden keep their horses for the spring ploughing, turned back to fields swept bare and desolate, villages whose life had first languished and then stood still, towns without trade or industry, where everything waited to be planned and begun anew, as if there had been no past to place foot upon. Their country had indeed, as General Lee said, to be "built up on a new basis." They carried back to it no smallest part of what the ravages and untold costs of war had stripped away. Their lives were divested of everything that belonged to the age gone by save only their thoughts: thoughts of irreparable loss, of principles long revered but now discredited, of a social order cut up by the roots, of a life thrust away to be henceforth a mere bitter mem-

THE CONFEDERATE STATES

ory, of a future of new effort to be faced with all the pains of utter disaster thick upon them.

Travellers from over sea had said that to cross the line between North and South was like passing from

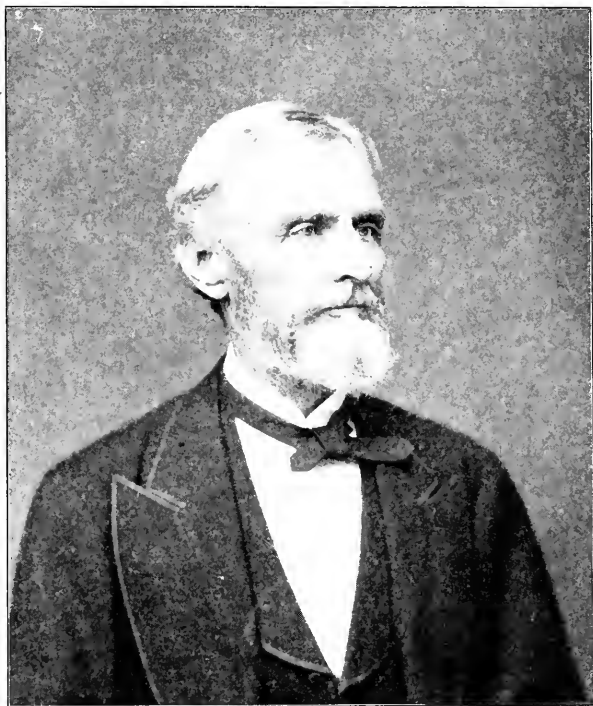

Jefferson Davis

JEFFERSON DAVIS

one century to another. In the one section they found an almost antique order of life, changed scarcely at all from that which settlers out of the elder England of the Stuarts and the Prince of Orange had established in Virginia and the Carolinas; in the other, all that belonged to the modern world,—communities quick with

the movements of a various commerce, busy with mining, manufactures, the construction of railways, the diversification of industry. The South kept still the social order and the social and political ideals of an elder generation. Slavery gave it a touch half mediæval, half oriental. There was something of the patriarchal way of life in the broad country-sides where masters of fields and flocks and herds went in and out upon their errands of superintendence among groups of dusky slaves; something, too, that recalled the mediæval lord and his serfs. And yet there was the air of the nineteenth century, too, the touch of democracy, in the plain and wholesome simplicity of the planters' lives, and their frank comradeship with all their neighbors who were of their own privilege of citizenship. The commerce of the modern world passed in and out at the southern ports as at those of the North. Southern merchants felt the spirit of the times in all their enterprises; railways brought the products of every land and region to their shops and warehouses; the impulses of the world and of its changing thought stirred there as elsewhere. What held the South back in the way of the older centuries was its unaltered, its unalterable social order, which belonged to the age in which the constitution had been devised, not to that in which its whole spirit and operation had been subtly changed by the pervasive processes of national growth.

When they conceived that the time had come to put their right of withdrawal from the Union into practice, the southern statesmen showed at once, with a manifest naturalness and sincerity, what generation they were of. They acted, with an all but unconscious instinct, upon the principles of 1788. They conceived the unmaking

of the constitution to be, not an act of revolution or of lawless change, but a simple, though it were solemn, legal transaction, like the formal abrogation of a great treaty; to be effected by the same means by which it had originally been adopted. South Carolina, who led in the fateful business, adjourned her legislature and called a constitutional convention together: a body like that which had declared her assent to the constitution in the far year 1788. By formal ordinance of that convention the ordinance of the convention of 1788 was repealed, and the connection of the State with the Union authoritatively severed. That was her act of "secession," taken in the highest sovereign fashion known to her law and tradition. As in 1788, so now there was no submission of the action of the convention to the vote of the people for ratification. A representative convention was as sovereign in South Carolina in 1860 as in 1788. The other States followed her example as of course. Their theory of constitutional right and practice was identical with hers. Each State in its turn called a convention, as in the old days of the formation of the Union, and committed to it as of course the sovereign determination of the political connections of the commonwealth. Each convention in turn repealed the ordinance of the convention which had stood in its place seventy years before.

And then, because the old process was being reversed and a government not made but set aside, the same conventions went on to take up the task of reconstruction, that another government, more to their liking, might be set up in the place of the familiar one now rejected. They chose delegates to meet at Montgomery and frame a constitution under which a government should be

established for the seceded States about to be combined in a new confederacy. When the work of the Montgomery convention was finished, they ratified and accepted it, without resort to the people or renewal of their authority. It was a critical time. Those who directed the unprecedented business were subtly aware, for all their stout theory of legal right, that the touch



MONTGOMERY, ALABAMA, IN 1862

of revolution was upon all that they did. The work was therefore hurried forward. Hot feeling was astir. Rumors of force to be used, of armed resistance by the North, were in the air. It was imperative that the new group of States should be ready as soon as possible with a common organization through which they could act effectively and to a common purpose. The convention at Montgomery, therefore, at once chose officers for the new government as well as a constitution, and

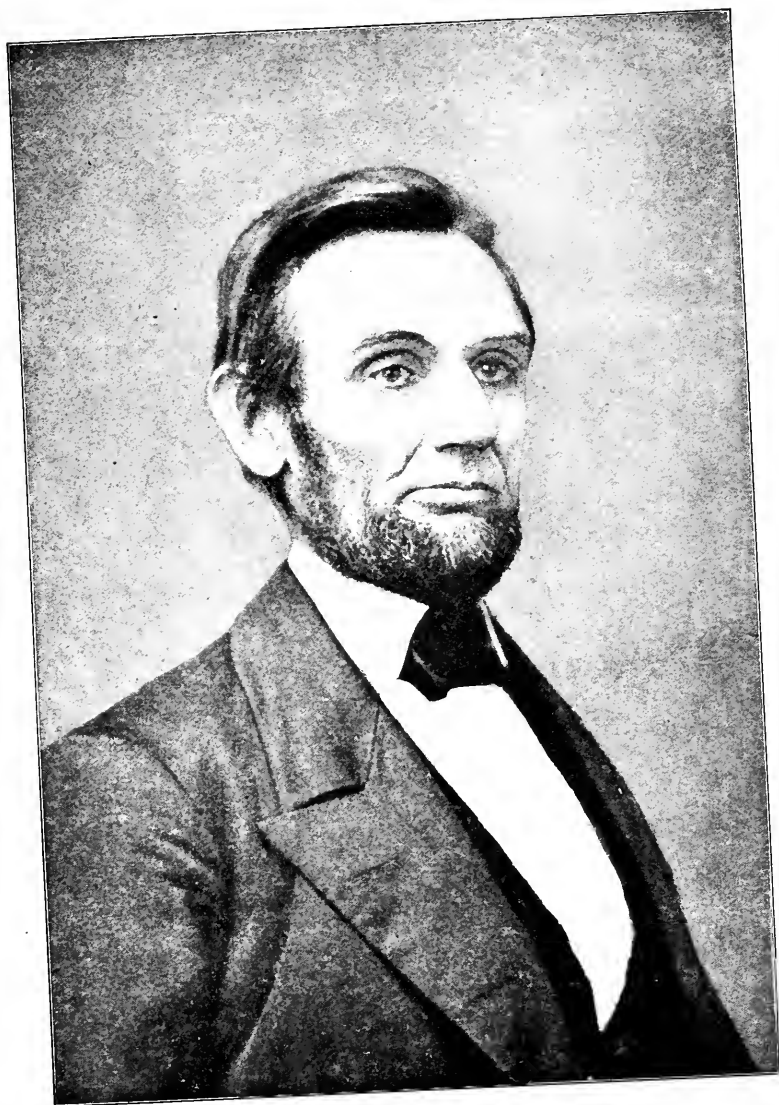

Abraham Lincoln

ABRAHAM LINCOLN

THE NEW YORK
PUBLIC LIBRARY

ASTOR, LENOX
TILDEN FOUNDATIONS

gave it an immediate temporary organization; and the sovereign conventions of the several States unhesitatingly ratified all that it did. Not until the year was out which had been fixed as the term of the provisional government was the direct action of the people asked for, except in Texas, which came to its resolution of secession while the new confederate government was in process of formation, and Virginia, which waited until it had been formed. In each of those States the ordinance of secession was submitted to the vote of the people and ratified by them. Even when the term of the provisional government had expired the voters of the new Confederacy were asked, not to ratify the constitutional arrangements upon which it had been founded, but only the choice of officers which the convention had made. They chose electors and members of Congress, merely, and affairs went on as they had been planned.

There was here no distrust of the people. No one doubted the legal validity of what had been done or deemed the method revolutionary or undemocratic. Nowhere else was there such homogeneity of opinion as in the South, nowhere else so habitual an acquiescence in conservative and established ways of action. It was not, however, a habit rooted in lethargy or indifference. Nowhere else in the world, perhaps, was there a more alert political population, a rank and file more keenly alive to points of political doctrine and practice. Politics were everywhere the favorite theme of conversation. Many a white man of the poorer class could read as little as any slave; but he heard his leaders so often upon every question of moment, whether of domestic or of foreign policy, at court, on market days,

at neighborhood rallies for political discussion or religious exercise, at public barbecue and festival, that news came to him without newspapers and the principles of politics without books. Every matter of large significance or small he heard debated by the best informed men of the country-side. They gave him, first or last, no small part of what they had learned by travel, by reading, by service in the public councils. Through them he knew the characters and the motives of public men, the gossip as well as the controversies of politics, the happenings and the humors of the wide world. With such things to talk about around the fireside and at the cross-roads shop, upon his long rides from plantation to plantation and with his cronies upon every casual meeting, he had more than books could have given him.

Southern speakers felt as much put upon their mettle before audiences gathered at their neighborhood hustings in the midst of a season of controversy as before any audience gathered in the capitol at Washington. Southern voters were not likely to be made dupes of. They had elected the men who sat in the sovereign conventions which cut their connection with the Union with a full knowledge of the business they were to meet upon, and did not doubt that the conclusions of those bodies were their own authentic acts. Political method was not in dispute among them. They accounted themselves disciples of Mr. Calhoun in respect of constitutional right and the legal remedy for abuses in the conduct of the federal government. What he had taught them was in their minds the commonplace and matter of course foundation of political theory. They did not doubt that they had the right to secede, or that sovereign

THE CONFEDERATE STATES

representative conventions were the proper instruments of secession.

But many of them had doubted the policy and the occasion. Men forgot afterwards the sturdy fight made



T. J. Jackson

THOMAS JONATHAN JACKSON

among the southern people for the preservation of the Union, by men whom all southerners loved and would upon ordinary occasion have followed right willingly; forgot the doubtful balance of parties and opinion there had been among them for many anxious years together.

That final breach and agitation between North and South had begun, not a single short year before, when Mr. Lincoln was nominated and the Republican party began to gather for its triumph, but in 1848, when the territory acquired from Mexico was to be disposed of as between North and South and southern men had insisted that the balance between the sections, disturbed in 1820 by the compromise concerning Missouri, should be redressed. Mr. Douglas's unpalatable doctrine of "squatter sovereignty" had deepened the mischief. He softened it as he could, to keep the southern men at his back; but the disguise of his careful phrases was stripped off by Mr. Lincoln in debate. The searching questions of a masterful opponent forced him to say that, though no law of Congress could exclude property in slaves from the Territories, the unfriendly provisions of territorial law itself might, if the settlers chose, render its tenure practically impossible. From that day the southern leaders knew that to act with a party which followed Mr. Douglas was to lose the constitutional battle they had fought a long generation through for the balance of power between North and South. There was steadfast love for the Union in the South as in the North. Mr. Calhoun had loved it, and it had broken his heart that he could not save it upon the principles which he conceived to be its heart and life. Men who knew the South only by some casual glimpse of southern men, some brief journey through the southern country, some transient sojourn of a single season, deemed the southern people as unstable, as easily stirred to rash action as a Gallic populace, so passionately did they seem to respond to the appeals of their orators, so eagerly did they yield themselves to the excitements of every



R. E. Lee

ROBERT EDWARD LEE

THE NEW YORK
PUBLIC LIBRARY
ASTOR, LENOX
TILDEN FOUNDATIONS

THE CONFEDERATE STATES

agitation. But they were an English folk, strengthened here and there by the sober Scots-Irish strain and the

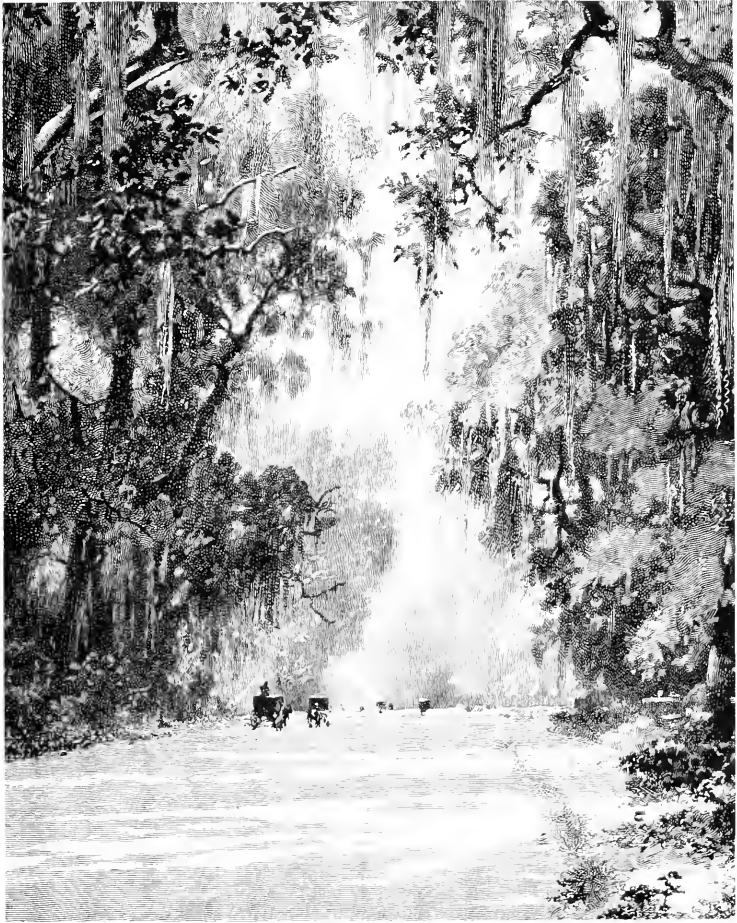

THE SHELL ROAD, MOBILE

earnest blood of the steadfast Huguenot. They held to their principles, their habits, their prepossessions with a simple, instinctive, undeliberate consistency

which no excitement of the moment really touched or unsettled. They had been schooled, as all the nation had, in a loyal allegiance to the Union which their own statesmen had done so much to set up and make illustrious. Whatever their old-fashioned view of the character of its constitution or of the rights of the States as members of the great partnership, no ordinary occasion, no sudden gust of passion could have torn their thoughts from those old moorings. It had taken a long twelve years of agitation to get them in revolutionary mood, and men whom they equally loved and heeded had stood all those critical days through on the one side and on the other in determined combat, some to save, some to break the Union. It was by appealing to their very conservatism, their attachment to the older models and theory of their government, that the advocates of secession had won.

It had been a battle of statesmen and orators, and only at the last had the advocates of secession triumphed. Many an influential planter in the South was by sheer instinct of class and tradition a Whig, and held himself, alike by interest and by natural obligation, an ally, not of the democracy to which Mr. Jefferson had given life, but of men of property and of vested right everywhere. If his neighbors and the small farmers and the tradesmen of the towns were Democrats, even they chose their party alliances by a conservative instinct: because they deemed the Democratic party a conservator of old views, the most trustworthy opponent of new-fangled doctrine and revolutionary change. Many a Whig planter believed devoutly in the sovereign rights of his State, and the preservation of those rights was at the very heart of every southern Democrat's creed;

THE CONFEDERATE STATES

but love of the Union and reverence for law underlay the thought of all alike and stuck fast in the stubborn fibre of an English race. It was such a people that went to school to its orators to learn the issues and the



ARLINGTON, THE RESIDENCE OF GENERAL ROBERT E. LEE

final purposes of the fateful decade 1850–1860. A few resolute men turned them to secession.

A single figure stood for a while, almost alone, at the front of the coming revolution, the figure of William L. Yancey, of Alabama. Before Mr. Calhoun died Mr. Yancey took up the theme which had darkened the last utterances of the aged Carolinian like a prophecy of ruin,—took it up, not as a counsel of despair, but as a counsel of duty. Compromise between North and South, he declared, was out of the question. In 1846 he resigned his seat in Congress because he would not

A HISTORY OF THE AMERICAN PEOPLE

act with any party which so much as debated the exclusion of slavery from the Territories; and went home



W. L. Yancey

WILLIAM LOWNDES YANCEY

to spend the remainder of his life and every power of his strong mind in the advocacy of a course which once and for all rejected compromise and accepted only the

doctrines which should forever safeguard the constitutional rights and material interests of the South, even though such a course should lead to a disruption of the Union. He was a man of no majesty of presence, no adventitious grace of manner; never studied his art as agitator or sought to catch the people by any assault of passionate appeal; but burned with a conviction which had its own dignity and irresistible might; used the ways of frank, direct, engaging speech which went most naturally with his open, unaffected nature; argued his case to the bottom, plead it with whole-souled ardor, as a thing not of expediency but of right, and was careless where it should take fire of itself. Above all, his words rang, upon every theme he touched, in a voice whose slightest tone thrilled along the blood, so rich, so flexible, was it, so compact of the quiet passion of the mind. While others wavered, caught now at this expedient and again at that to turn the current he was setting against them,—against the Union itself,—he held steadfast, undoubting, to his simple theme. Majorities followed him and left him; conventions heard him now with acquiescence and again with deep disquietude and passionate dissent; but no man could decline to listen when he spoke, and none who heard him could long steel himself against the charm and power of his appeal. It was the tones of his voice, the resonant echo of his theme, that seemed to linger in the air after every controversy. It was he more than any other who taught the South what Douglas really meant; he, more than any other, who split the ranks of the Democratic party at Charleston, made the election of Douglas impossible, and brought Mr. Lincoln in.

He had foreseen what must come, and hesitated as

little after the event as before it. He was for immediate and final secession; and, though he had to carry the fight to the very floor of the convention of his State, met to make the final critical decision, he won it there, by an initial majority of eight votes. Twenty-four members of the convention stood out against the action to the very last, and refused to put their names to the fateful paper which cut their connection with the Union; but the people accepted the decision of the majority, and he had his way. Men whom they had followed through many a long year, when Mr. Yancey was only their incomparable orator, not their leader, the people now rejected; and their own capital town of Montgomery saw the government of the Confederacy set up.

Georgia had been won by a like slow and stubborn contest, doubtful till the very last. Even Mr. Stephens had held stoutly, indomitably to the side of the Union until the final movements of the fight had been lost and won,—the slender, delicate, singular man whom the convention at Montgomery made Vice President of the Confederacy: a man whose fragile, shadowy body seemed scarcely able to endure the keen flame of his thought. He admitted the legal right of secession, but he turned upon every argument of expediency or necessity urged in its favor a searching light of ridicule, criticism, satire which it was hard for any man to stand in and not flinch. The piercing tones of his high-pitched, feminine voice seemed to add to the cutting force of his words. But men of a different sort had overborne him. One figure in particular took the imagination and ruled the spirits of that susceptible people, the figure of Thomas R. R. Cobb. The manly beauty of his tall, athletic person; his frank eyes on fire; his ardor,



THOMAS R. R. COBB

as of a man not arguing a case of politics or expediency but given over to a cause not less sacred, not less fraught with the issues of life and death, than religion itself; his voice, as musical and as sure to find its straight way to the heart as Mr. Yancey's, made his words pass like a flame from country-side to country-side.

There could be no doubt what the constitution of the Confederacy should be. The advocates of secession had not rejected the constitution of the United States as it had been in the first days, when read, as they conceived, in its simplicity and original import, but only the corrupt interpretations which had been put upon it, the leadership of parties which would have wrested its meanings to the South's destruction. They made a constitution at Montgomery, therefore, which they meant to be in all essential things a counterpart of the constitution of the Union which they had abandoned,—except that in their own document what they held to be the implicit meanings of that constitution were made explicit, and its errors and weaknesses of detail corrected. "We, the people of the Confederate States, each State acting in its sovereign and independent character," ran its preamble, in order that the rôle of the States in the free partnership might not again be questioned. Protective tariffs it specifically prohibited, as well as all internal improvements at the general charge; and the power to emit bills of credit it did not grant. The recognition and protection of slavery in all territories of the new government it made an explicit principle of fundamental law. The importation of negro slaves from foreign countries, on the other hand, it explicitly forbade; and the Congress was given power to prohibit the introduction of slaves from

THE CONFEDERATE STATES

any State or Territory of the older Union. New States were to be admitted only by a vote of two-thirds of each

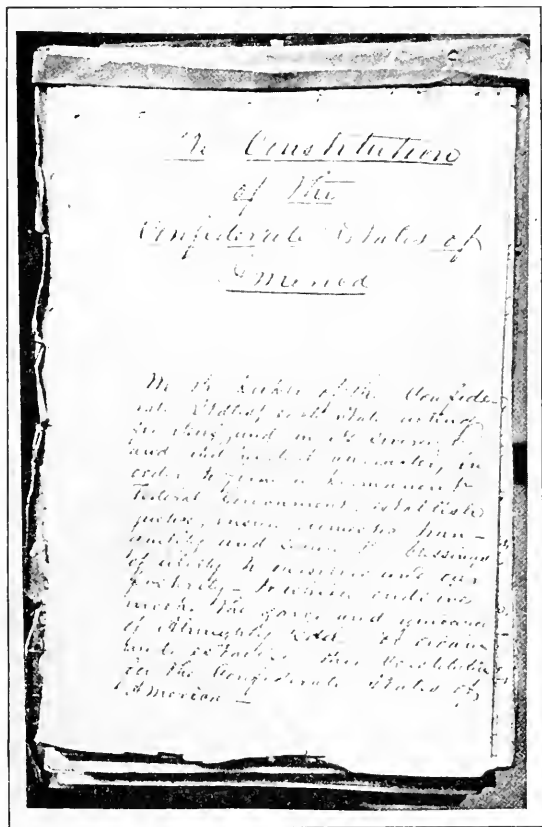

FIRST PAGE OF THE ORIGINAL DRAFT OF THE CONSTITUTION
OF THE CONFEDERATE STATES

house of Congress, "the Senate voting by States." Every state legislature was accorded the right to impeach confederate officials whose duties lay entirely within its own territory. The demand of "any three

States assembled in their several conventions" was made sufficient to secure the calling of a convention of all the States for the amendment of the constitution. It was thought best, in view of experience in the older Union, to extend the presidential term to six years, and to make the President ineligible for re-election. The President was explicitly given authority to remove at his pleasure the principal officer in each of the executive Departments and all persons connected with the diplomatic service; but he was empowered to remove other civil officers only for dishonesty, inefficiency, misconduct, or neglect, or when their services were unnecessary, and he was required to report to the Senate his reasons for removal in every such case. He was granted the right to veto individual items in appropriation bills; and the Congress was forbidden, except by a two-thirds vote, to make any appropriations not asked for and estimated by the heads of the executive Departments, unless such appropriations were for the legitimate expenses of Congress itself or for the payment of just claims against the government which had been judicially determined. Congress was authorized to grant seats upon its floor and the right of debate upon all public measures to the heads of the several executive Departments, in order that Congress and the Executive might act in closer harmony and easier co-operation than had been possible in the old Union.

There was to be no time of peace, it turned out, in which to make test of these new provisions. They bespoke men as their authors who had kept an observant and sagacious eye upon affairs, and who had perceived very clearly where some of the dangers and inconveniences of the older system lay; but no work of crit-



Andrew Johnson

ANDREW JOHNSON

icism or of reconstruction was of much avail amidst the furious storms of war into which the new government was plunged from the very outset. Whatever frame of government they might have devised, the Executive must have stood supreme at the front of all action while war held, a war for very existence. A nice balance of constitutional adjustment was out of the question. Counsel was hastened, debate postponed; the exigency of each occasion determined the means and the mode of action. Constitutional safeguards gave way to the mere problem of making the existence of the government good upon the battle-field. Critics of what was done might for a little while affect opinion out of doors or at a distance from the field, but they could not change the course of affairs. Moreover, war itself altered the whole atmosphere of opinion. No doubt at first the people had been persuaded, perhaps overruled, by a handful of leaders, and had assented with a vague hope rather than with any confident purpose to the radical courses of secession, resentful of the wrongs they conceived themselves to have suffered in the Union rather than desirous of independence or of a new government set up in rivalry to the old upon that familiar seaboard. They had been assured that there would be no permanent separation: that new terms and a stricter understanding of rights must be had with the northern partners, and that better terms could be made out of the Union than in it, by secession than by submission. No doubt their leaders had themselves believed this, had actually hoped to see their States re-enter the old Union with a new security for their interests, a firmer, more definite position of right. Only the actual use of force against them had

changed their temper and their hope; and war had wrought as deeply upon the spirits of the people as upon their own. When once the call to arms was made, doubts dropped away, the spirit of a whole people leaped within them, the very provisions of their new constitution became for the time almost a matter of indifference. Debate was over, and spontaneous action had begun, touched with a new ardor and a terrible enthusiasm.

Not every one, indeed, was caught by the new passion. Here and there groups of men held stubbornly off from the desperate business and would not be drawn into it. In one of the northern counties of Alabama, Mr. Yancey's own State, Union men outnumbered secessionists four to one and maintained themselves in military organization. A southern county of Mississippi accepted the doctrine of secession, indeed, but interpreted it in its own behoof, and itself solemnly seceded from the State and from the Confederacy rather than send its men to distant battle fields. And yet the real burden of the war fell, not upon the spirits of men, but upon the resources of the country. Though the South should call upon every man of her fighting population to go into the field, she had but one-fourth as many men fit for the field as the North. Armies must be fed and clothed, besides, and the South was put to the utmost strain to keep her men as well even as the ragged levies of the Revolution had been kept, who had deemed it a plentiful bounty to escape starvation. A four years' war was of necessity a war of resources, and the South was but an agricultural region, its population spread widely abroad over a great area, only here and there a railway, its matchless stores of coal and iron almost untouched, no manufactures set up, save here and there

a cotton mill or a woolen factory, its own cotton woven, for the use of southerners themselves, chiefly in the great manufacturing centres of the North.

Southerners knew themselves dependent on Europe or the northern States for almost every yard of cloth, every coat or shoe or hat that they wore; for their agricultural implements, carpenter's tools, wagons, cordage, nails, harness, saddles, axes, tubs, buckets, their very chemicals and medicinal drugs,—for everything except their bread and meat. The war shut them close within their boundaries. The cordon of blockading fleets all but sealed their ports; the steady extension of the federal lines down the valley of the Mississippi River and across the broad reaches of the States of Mississippi and Tennessee to the southern spurs of the Appalachians at Chattanooga thrust their western frontier in to the mountains. Between that impenetrable wall and the closed seas they were pent up, with no markets, no means of life or comfort or subsistence, no military supplies save such as they could themselves make or take from their enemy. They could get no more railroad iron, no more locomotives, no more railway carriages or cars for freight, no more steam boilers or engines, no more telegraph wire, no more spades to use in the trenches, unless, in the midst of war, they created out of hand an entire industrial system, for which they had neither trained master mechanics nor fit workmen.

Her cotton, her tobacco, and her rice, had supplied the South with the wealth with which she had paid the prices of the world for her clothing and her tools and all the varied product of the factories. Of the great staples rice and cotton she had almost a monopoly. Her cotton fields supplied half the world; her rice and

THE CONFEDERATE STATES

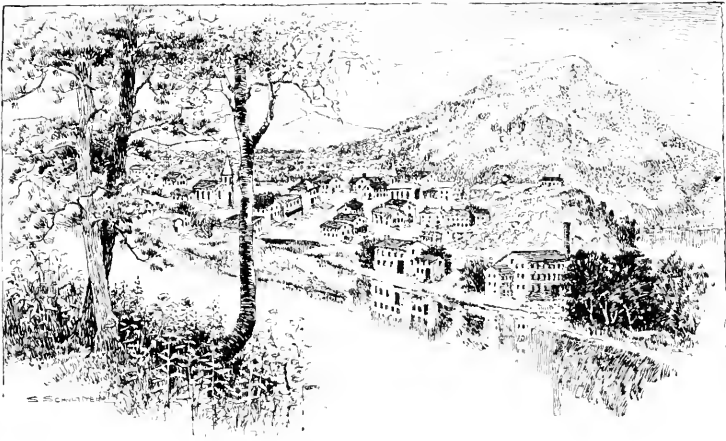

CHATTANOOGA, TENNESSEE, IN 1862

tobacco found their way into every market. Nearly one-third of the Indian corn of the country, moreover, came from her plantations. But, without markets, the crops were valueless. The value of the cotton exported in 1860 had been \$202,741,351. In 1861 it was but \$42,000,000; in 1862 but \$4,000,000. The value of the rice exported in 1860 had been \$2,567,399. The value of that exported in 1862 was \$156,889. The rice fields, moreover, lay upon the exposed southern coasts, where the federal fleets gathered stronger and stronger month by month, and had presently to be abandoned. It was no slight embarrassment and bred a great disturbance of values that there was no way, so long as she was thus shut in, by which the South could replenish her stock of specie. Some specie there was, of course, in the banks; some came in at the outset by way of loans obtained abroad, before the blockading fleets were numerous enough to intercept it; but its

quantity was insignificant as compared with what was needed to hold the currency stable when treasure was being poured out for the war. The bulk of it was paid out almost at once to meet foreign balances. Private individuals hoarded all they could lay their hands on, and it practically passed out of circulation. Paper money took its place, the promises of States as well as of the confederate government itself; grew in volume from month to month with startling rapidity; and sank in value as the old continental paper had sunk in the days of the Revolution. No man knew for how much he was selling his crops when he sold them for paper. No man could guess how much of that questionable currency would be necessary to pay his debts another year. Postal clerks at Richmond presently found themselves obliged to resign because they could not live on a salary of nine thousand dollars.

Abundant harvests of grain filled the fields all the anxious four years through. The smiling valley of the Shenandoah and the fertile fields of central Georgia had been the chief granary of the South. The Shenandoah was swept from end to end by the contending armies; the grain of central Georgia ripened just in time, in 1864, to feed the army of General Sherman as it pushed southward to the sea. But other fields supplied what the ravages of war destroyed. Cotton being no longer salable, provident planters sowed corn in its stead. What seemed next to impossible was to get the grain to market. The railways were in constant use by the armies; the common roads were falling into utter disrepair; wagons and teams were at the front with the soldiers; many a household within but a few miles of well-filled granaries found itself put to sore

straits to get food. It was hard, moreover, to live on maize alone. Very little wheat grew in the southern fields; very far from enough to supply all the southern country with wheaten bread. Southern housekeepers were put to their wits' ends to devise means to diversify the diet of their households and make it wholesome. New food stuffs were brought into requisition: peas that had before been offered only to cattle, roots that had hitherto been thought only curious or medicinal. Coffee and tea were shut out with the closing of the ports, and every possible substitute was tried.

And yet to get food was a simpler matter than to get shoes and clothing. Looms which had not seen thread since the Revolution were brought forth out of attics and put to the task of making "homespun" for a whole household. Since tanneries were few and used their primitive processes with infinite slowness, leather could scarcely be had; and when shoes wore



A STREET HUCKSTER IN RICHMOND,
VIRGINIA

out there was nothing for it but either to go barefooted or substitute rude wooden clogs shod with iron. Men followed the armies to pick up for the tanner the hides of the animals slaughtered for the soldiers' food. Riding saddles were stripped of their skirts that no piece of leather might be wasted. In mild weather the children could go without shoes; in severe weather they were kept within doors. The very cards with which the cotton fibre was carded for use on the looms had teeth of steel wire which could not be replaced when they wore out, and every card was guarded and mended like a priceless treasure. Infinite care and a novel ingenuity gave to every domestic duty a new significance. Every plantation had its smoke-house, and before the war came on carefully cured hams and sides of bacon had furnished the commonest dish of meat, whether for the table of the slave's cabin or of the master's house; but the South had then imported its salt. There were but one or two salt mines within the borders of the Confederacy; and when armed men and ships had been drawn about those borders there was not salt enough for the smoke-houses. There was scarcely enough for the kitchen. The very floors of the smoke-houses were scraped for the salt that might be got from the drippings of past years; and gentle and common alike went without their accustomed dish of bacon.

The armies, of course, suffered most from every kind of want that had come upon the land. To march without shoes, to make shift with torn and ragged clothing which there was little hope of replacing, to fight and endure hardship on half-cured bacon and a scant dole of hard corn bread, to go without coffee or any stimu-

lant, and finally to lack even healing medicines in the inevitable hospital put men of the stoutest constitution to tests more fatal oftentimes than those of the battlefield itself. There was coarse food enough in the country, but the government had scant means of paying for it and had no efficient commissariat through which to make sure of supplying the armies even with such things as it could obtain. One difficulty that immensely increased from year to year was the utterly insufficient means of transportation. There were a few long lines of railway which linked the main towns and sea-ports of the country together; but the armies could not be always lying close to these, and there were few side lines by which to reach the camps if the movements of the war drew the armies to a distance. Such lines as there were, moreover, hopelessly deteriorated from month to month.

Such iron and steel works as the Confederacy contained or could build while the war lasted had to be used almost exclusively for the manufacture of cannon and military supplies, and could not have



SELLERS OF FIREWOOD IN RICHMOND,
VIRGINIA

been drawn off from that indispensable work to make new rails and locomotives and car trucks for the railways even if there had been iron enough. And there was not iron enough. The country had to be stripped of every spare scrap of iron to make and repair the weapons of war. When rails wore out they could be replaced only by tearing up sidings and minor lines of road. When rolling stock fell into disrepair no new cars could be had. When the war was over little more seemed left of the railways than their graded road-beds and odds and ends of their rolling stock hardly fit for further use.

The commanders in the field often found themselves as hard put to it to obtain military stores as to get food and clothing. The devoted women at home sent thousands of homespun garments to the front for their sons and husbands and brothers, and warm socks without number knitted with their own hands; even cut their carpets up to be sent to the camps for blankets; but the women could not make powder and guns. Considerable supplies of arms and munitions had been got in from England before the blockade was drawn tight about the ports, and across the border through Mexico before Texas and the Gulf ports had been cut off from the rest of the Confederacy by the pressure of hostile armies down the valley of the Mississippi. At the first act of secession southern forts and arsenals had been seized with large supplies of arms. General Jackson made rich prize of military supplies at Harper's Ferry; and many another success in arms swept the booty of the field into the confederate chests and armories. But with all this there were not arms enough for the great musters that went to the front. Cannon

and arms had to be made, and made without materials except such as were already at hand. Every brass bell that could be found went to the foundry to be melted down and cast into cannon. Devoted housekeepers

even contributed their brass preserving kettles and every piece of household brass that could be spared. Private fowling pieces were used when muskets lacked, and ancient muskets and side arms came once more into use which had hung upon the wall as curious heirlooms ever since the days of the Revolution.

All the fire-arms used by the confederate armies were muzzle-loaders, and the mere supply of percussion caps became a matter of no small difficulty. A mechanic at the Richmond arsenal, the chief factory of arms, ingeniously



A SUPERANNATED DARKY IN RICHMOND, VIRGINIA

contrived a machine by means of which a million caps could be pressed and filled every twenty-four hours; but the loss of the copper mines of Tennessee followed the occupation of Chattanooga by the federal forces, and the supply of sheet copper out of which

the caps were made was suddenly cut off. An officer was despatched, accordingly, to North Carolina to buy and forward to Richmond every turpentine and brandy still he could find in the State, and the copper from these supplied all the caps used by General Lee's army during the closing year of the war. The caps were usually filled with fulminate of mercury; mercury could be had only from abroad; and the supply gave out. Diligent experiment was made, and it was discovered that a combination of chlorate of potash and sulphuret of antimony could be successfully substituted. The inventive genius and practical resourcefulness of men and officers alike were quickened by the extraordinary exigencies of those fearful years to make the most of what they had. Common glass demijohns were converted into contact torpedoes to close the channels of the southern rivers, and did their work with terrible execution. An assaulting party rolled bales of cotton before them for shelter as they worked their way forward to the storming of a position. Skilful and experienced mechanics were lacking, foundrymen, ship carpenters, engineers,—for the South had hitherto had no need of these; but every man of education in the armies turned his wits and knowledge to practical account upon occasion and supplied the lack as best he could.

Almost every white man of fighting age, and many who were too young or too old for the field, came first or last into the ranks, and the war seemed to be using the whole capacity of a proud and capable race. Hundreds of thousands volunteered; the rest were drawn in by conscription. Where it was necessary to use the entire fighting population it was impossible to rely on vol-

untary service, and the South, with its scant numbers for the field, resorted to conscription sooner than the North. It was absolutely necessary, of course, to leave some men at home to do the indispensable work of peace by which homes and armies alike were to be supported ;

TO ARMS! TO ARMS! VOLUNTEERS!

To the Citizens of McLean County :

By virtue of the Proclamation of His Excellency, the Governor of the State of Illinois, the Sheriff of each County, (where there are no officers in command,) is authorized to raise volunteer companies, and forward them to Springfield, the place of general rendezvous, to join the Illinois army in aid of the Federal Government, in the suppression of rebellion and insurrection :

Therefore, all persons that will volunteer, are requested to come to my office in Bloomington, and enlist; and as fast as companies are formed, they will be immediately forwarded to Springfield.

Each Company to consist of

One Captain,	Four Sergeants,	Two Musicians,
First and 11 Lieutenants,	Four Corporals,	Eighty Privates,

Each Company to elect their own Officers.

One Company has already been raised in Bloomington, and I hope to be able to raise one or two companies more in McLean County.

OUR COUNTRY CALLS!

Let every Patriot that can leave his home and business for a time, promptly obey that call. I further propose that everybody meet in Bloomington, on MONDAY, 22d inst., at 12 o'clock, to aid and counsel in the aforesaid object.

JOHN L. ROUTH,
SHERIFF OF McLEAN COUNTY.

Bloomington, April 18, 1862.

A CALL FOR VOLUNTEERS IN ILLINOIS

but men enough even for that were not left at last, so inexorably had a drastic conscription swept the country of every possible soldier. So early as April, 1862, the confederate Congress had made all between the ages of eighteen and thirty-five subject to military service; in September of the same year it extended the obligation

to men of forty-five; and before the end of the war it had called upon boys of sixteen and old men of sixty. Slaves served the armies from the first as body servants, teamsters, hostlers, cooks, and laborers on the fortifications. Before the war closed the confederate Congress, in its straits for men, authorized, with something like general approval, the enrollment of slaves as armed troops; but not until the end was at hand and the measure too late to be of practical importance.

Such measures were but a proof of how the southern country was being stripped of everything, its men and its resources alike. There was proof in every action of the new government they had set up of the exigent difficulties, the utterly disconcerting perplexities brought upon the southern people by that unparalleled upheaval of civil war. In all counsels southern men had stood foremost in the advocacy of a central government of strictly defined and carefully limited powers, which should give to individuals and States the utmost possible latitude of independent privilege compatible with the maintenance of political authority and social order. They had flung out of the Union because the federal government had seemed to them to go too far in the arrogation of power. And yet the government they themselves had set up by way of protest became, amidst the entanglements of a war which involved its very existence, a power centralized beyond example in the history of America. Not only did all authority centre at Richmond, but all power at Richmond centred in the President and the heads of the executive Departments, particularly the Secretaries of the Treasury and of War.

The North had a like taste of the consequences of

war. Mr. Lincoln himself could not curb the wilful mastery of his Secretary of War. The rights of individuals gave way before the orders of an executive

department: the supremacy of the war party and the power of the army were the law of the nation's life. But there was a limit. The courts were open; the law was not silenced; men lived their ordinary lives and were unmolested so long as they kept their hands from affairs which touched the government. Trade and peaceful employment were not throttled by a cordon of fleets and armies drawn about the land. Opinion moved openly and was outspoken, and every man could draw for himself the limits even of a government grown despotic to save the Union. But in the South war was, for the time being, the occupa-



A SELLER OF RABBITS AND HARES,
RICHMOND, VIRGINIA

tion and absorbing interest of a whole people. No man could draw wholly apart and live his own life. It was necessary, moreover, that the action of the war should be ordered, not by legislation and debate, but by ex-

ecutive authority, central, efficient, unquestionable. It was no time to stand on the punctilios of law. There was no certain means, indeed, of determining what the law was. The supreme court provided for by the constitution of the Confederacy had not been organized. War had come too soon. Litigation was postponed to the necessary first task of making the government sure of a chance to live at all.

The houses could exercise no real restraint upon the Executive, because they did not put themselves into a position to understand or control it. Mere hereditary jealousy of executive influence made them unwilling to act upon the provision of their constitution which authorized them to bring the heads of the executive departments into their sittings to answer questions and take part in debate. There was, therefore, no intimacy of common counsel between Congress and the Executive; and the Executive, standing in the midst of affairs, standing where action was imperative, power necessary, debate perilous, stood at the centre of all initiative. Congress had no choice but to uphold its hands, and back it with the measures which the time, not statesmen's preferences, made necessary. Bitter debates from time to time marked its action. Sharp criticisms which cut to the quick of motive and policy rang in its halls. Many a battle of will against will disturbed the relations of the President and the houses. But more and more did the drift of war sweep all counsel into its current. Year by year the houses were emptied of their abler members, as the continental Congress had been in the old days of the Revolution. They were more needed for service in the field than for debate at Richmond. It grew less and less possible,

THE CONFEDERATE STATES

moreover, to discuss the exigent matters of the war with open doors, through which voices of censure and doubt, of discord and protest, might get abroad, to the demoralization of opinion and the heartening of foes. From the first, when subjects of defence were under discussion, the sessions of the Congress had been secret.



A WOOD PEDDLER, RICHMOND, VIRGINIA

More and more did every question seem to become a question of defence, until at last secret sessions became the rule, open sittings the exception.

It was in part the prudence of defence, not against enemies in the field, but against opinion within the Confederacy itself, that led the houses to close their doors so often. Opinion moved very uneasily under the masterful action of the government. Men were silenced rather than convinced. The right to the writ

of *habeas corpus* had been promptly suspended in the South, as in the North. Those who showed themselves too openly out of sympathy with the government soon learned that arrest would follow a frank expression of their views. Even freedom of movement from place to place was restricted: no one could stir far abroad from his home without a passport from the government. There was little to wonder at if men chafed hotly under restraints which kept the hand of government, it seemed, upon every individual's thoughts and affairs. It had never been so before in the history of America. It almost passed belief that it should be so now in the South, where men loved individual dignity and independence with an abiding passion. It was singular how docile proud men became. Only once was there any notable instance of resistance to the government's sweeping acts of power. Governor Brown, of Georgia, when the conscription laws seemed to him to have passed all reasonable bounds of exaction, refused in set terms to allow the confederate recruiting officers to put the law into execution within the State. For the rest, there was hardly more than quiet distress and muttered protest.

The financial measures of the government showed the straits to which it was put to support the struggle, and the extraordinary lengths to which the exigencies of the war were stretching its powers, quite as clearly as its wholesale drafts of men and its arbitrary arrests in rebuke of dissent. In its need for money the government had resorted to every expedient known to finance, even the most drastic and desperate. Money it knew from the first to be scarce. The banking capital of the South was but one seventh that of the North;

the accumulation of specie and of stocks of goods out of all proportion smaller, and more restricted in geographical distribution. At the very outset provision was made for the payment of taxes in kind. When its redundant issues of Treasury notes failed to add enough to the direct taxes to meet the necessities of the exchequer, the government sought and obtained of the planters loans from their crops,—promises of the payment into the Treasury of a certain proportion of the yield of their fields, in return for eight *per cent.* bonds. When the time came in which the crops could not be sold for lack of a market, the government directly purchased the products of the fields, paying for them with bonds, for lack of anything else to pay. The several States themselves took supplies from the people for the troops they had undertaken to maintain in the field, and paid for them only with their own certificates of indebtedness. The property of all alien enemies was confiscated. In 1863, as it came to the final pinch of necessity, Congress authorized the seizure of food supplies at rates fixed every sixty days by state commissioners. There was hot protest and indignation at this, but necessity had become the law of the land. Some might grumble, and even make as if they would resist, but there was in fact no limit to the devotion of the people to the cause they had espoused. Women gave their very hair to be sold for the support of the government their men had sworn to establish.

Before the end came that government had thrust its hand into practically every affair, whether public or private, that touched the sources of life. It had even gone into trade. When all money was spent loans and taxes came into its hands in the shape of the crude

products of the soil. Cotton and food stuffs were a kind of legal tender in trade, but the stocks which accumulated in the government store-houses were too great and bulky to be made currency of in the purchases of the executive departments. The cotton, especially, it could not get rid of unless some exit could be made to foreign markets. The Treasury Department, therefore, would grant no clearance papers to any vessel preparing for the desperate attempt of running the blockade which did not make up at least one half its cargo out of the government stores. Blockade running became a sort of government monopoly, either in the hands of the state governments or in the hands of the government at Richmond. Both what should be taken out and what should be brought in were determined by those who had charge of public affairs.

The wealth and resources of the North increased and were multiplied, the while. Four million seven hundred thousand acres of the public domain at the West were taken up by new settlers, who moved forward to occupy them as if in a time of peace. Nearly four thousand miles of railway were built. The value of imports leaped up to a sum which presently almost equalled for the North alone the total value of the imports of the whole country in 1860, the South included. Manufactures flourished as if under a new stimulation. Though it was spending blood like water, the population of the North was replenished; though money was poured out as if drunk up by the very soil of the battle fields, wealth kept pace with the demands made upon it, and more than kept pace.

One of the most distressing evidences of the straits the South had been brought to was the state of the

prisons in which she was forced to keep the thousands of prisoners who fell into the hands of her armies. More than two hundred thousand, first and last, were taken; and only some sixteen thousand of these were paroled upon the field. There were as many southern soldiers in the northern prisons. Not until the war seemed turning towards its end could an exchange of prisoners be arranged. The federal authorities knew their superiority in fighting population and did not care to lose it by returning fighting men to the South. If her soldiers died in southern prisons, they were dying for their country there, General Grant said, as truly as if they lost their lives in battle. Thirty thousand men died in the confederate prisons; as many more in the prisons of the North: the numbers almost exactly balance,—in the South, 30,156, out of 196,000 who were prisoners; in the North, 30,152, out of 227,000. But the causes were different. In the northern prisons the bitter chill of winter claimed as many lives as the rigors and privations of prison discipline. In the South there were not prisons, there were not guards, there was not food enough. Men could not be spared from the field to guard the prisons, and many thousands were crowded together under a handful of men. Proper sanitary precautions were in the circumstances impossible. The armies themselves lacked food and went without every comfort, and the prisoners could fare no better,—inevitably fared worse, because they were penned within a narrow space and lacked the free air of the camp. A subtle demoralization touched the government of the Confederacy itself as the war went its desperate course, and those who kept the prisons felt that demoralization with the rest.

Address delivered at the dedication of the
Cemetery at Gettysburg.

Four score and seven years ago our fathers
brought forth on this continent, a new na-
tion, conceived in Liberty, and dedicated
to the proposition that all men are cre-
ated equal.

Now we are engaged in a great civil war,
testing whether that nation, or any nation
so conceived and so dedicated, can long
endure. We are met on a great battle field
of that war. We have come to dedicate a
portion of that field, as a final resting
place for those who here gave their lives
that that nation might live. It is alto-
gether fitting and proper that we should
do this.

But, in a larger sense, we can not dedie

FACSIMILE OF MR. LINCOLN'S AUTOGRAPHIC COPY OF THE GETTYS-
BURG ADDRESS, MADE BY HIM FOR THE SOLDIERS' AND
SAILORS' FAIR AT BALTIMORE, IN 1864

acts— we can not consecrate— we can not
hallow— this ground. The brave men, liv-
ing and dead, who struggled here have con-
secrated it, far above our poor power to add
or detract. The world will little note, nor
long remember what we say here, but it can
never forget what they did here. It is for us
the living, rather to be dedicated here to
the unfinished work which they who fought
here have thus far so nobly advanced.
It is rather for us to be here dedicated to
the great task remaining before us— that
from these honored dead we take increased
devotion to that cause for which they gave
the last full measure of devotion— that
we here highly resolve that these dead shall
not have died in vain— that this nation,
under God, shall have a new birth of free-
dom— and that government of the people,
by the people, for the people, shall not pass
from the earth.

Abraham Lincoln.

November 19, 1863

No one could wonder to see even a people such as the southerners had shown themselves to be lose heart at last, acknowledge the bitter fortunes of those last days intolerable, and yield in a sort of despair. It had taken all the vigor and audacity of their government to keep them to the hopeless business as the year 1864 disclosed what it had in store for them. Not a little of the dogged perseverance and undaunted action of those closing months of the struggle had been due to the masterful characteristics of Mr. Jefferson Davis, the President of the Confederacy. He had served a distinguished apprenticeship in arms in the Mexican war, a still more distinguished apprenticeship in affairs in the cabinet and in the Senate of the United States. He had the pride, the spirit of initiative, the capacity in business which qualify men for leadership, and lacked nothing of indomitable will and imperious purpose to make his leadership effective. What he did lack was wisdom in dealing with men, willingness to take the judgment of others in critical matters of business, the instinct which recognizes ability in others and trusts it to the utmost to play its independent part. He too much loved to rule, had too overweening a confidence in himself, and took leave to act as if he understood much better than those did who were in actual command what should be done in the field. He let prejudice and his own wilful judgment dictate to him the removal of Joseph E. Johnston from the command at Atlanta, the only man who could have made Sherman's march to the sea impossible. He sought to control too many things with too feminine a jealousy of any rivalry in authority. But his spirit was the life of the government. His too frequent mistakes were the result as

much of the critical perplexities of an impossible task as of weakness of character. He moved direct, undaunted by any peril, and heartened a whole people to hold steadfast to the end.

The end came with every sign of sheer exhaustion and despair. Many a southern man had gone into that terrible contest against his better judgment, not wishing to see the Union broken, but yielding to his neighbors' views and the challenge of the summons to arms. Such men were a minority, here and there very strong, but nowhere strong enough to make their will prevalent in affairs; and they had very loyally offered their lives and their property for the cause they would rather have seen vindicated in some other way. When those last days came they took heart to acknowledge the inevitable, and to urge peace as a mere means to avoid utter destruction. While they cried to their rulers peace seemed to come almost of itself. The southern armies melted away by wholesale desertion. There was nothing to eat, there was next to nothing to put into the guns themselves; the women and children at home were starving as well as the men in the camps, their only helpers and protectors. It was more than the human spirit could bear. Men turned by the hundreds, by the thousands, by the tens of thousands from the camps to the roads which led homeward. The end had manifestly come. There was no need to stay to see it come. If they stayed at all, how could they leave until it came; and how could the women and children wait? When the surrender came federal rations had to be served out to those who were left to save them from the helpless weakness of starvation.

And so their land was to be "built up on a new basis,"

as General Lee said. The South had thrown her life into the scales and lost it. There had been extraordinary devotion and heroism and mastery on both sides, —in the South a devotion and sacrifice hardly to be matched save in some war of religion; armies of the same race and breeding had met and neither had known how to yield; the end could not come until one or the other was overwhelmed; the South had been overwhelmed; and the most terrible war of modern times was over. Statesmen and patriots might well look about them and see with a sort of dismay what there was to be reconstructed throughout the whole fabric of the national life. The Union had been saved; it was yet to be rehabilitated.

Most of the *authorities* for this chapter are to be found mentioned under the *sources* at the end of Chapter IV.; but there are a few which should here be added: J. L. M. Curry's *The Southern States of the American Union* and *Civil History of the Government of the Confederate States*; J. C. Schwab's *Confederate States of America* (chiefly a financial history); Frank A. Montgomery's *Reminiscences of a Mississippian in Peace and War*; J. W. Du Bose's *Life of William L. Yancey*; William Garrott Brown's *The Lower South in American History*; David Dodge's *Domestic Economy of the Confederacy* in volume 58 of the *Atlantic Monthly*; John S. Wise's *End of an Era*; and various essays scattered through the *Publications* of the Southern History Society.

APPENDIX

PARALLEL CONSTITUTIONS

CONSTITUTION OF THE UNITED STATES OF AMERICA

We, the people of the United States, in order to form a more perfect union, establish Justice, insure domestic Tranquility, provide for the common defence, promote the general Welfare, and secure the Blessings of Liberty to ourselves and our Posterity, do ordain and establish this CONSTITUTION for the United States of America.

ARTICLE I.

SECTION 1. All legislative Powers herein granted shall be vested in a Congress of the United States, which shall consist of a Senate and House of Representatives.

SECTION 2. The House of Representatives shall be composed of Members chosen every second Year by the People of the several States, and the Electors in each State shall have the

CONSTITUTION OF THE CONFEDERATE STATES OF AMERICA

WE, the people of the *Confederate States*, each State acting in its sovereign and independent character, in order to form a permanent federal government, establish justice, insure domestic tranquility, and secure the blessings of liberty to ourselves and our posterity—*invoking the favor and guidance of Almighty God*—do ordain and establish this Constitution for the *Confederate States of America*.

ARTICLE I.

SECTION 1. All legislative powers herein *delegated* shall be vested in a Congress of the *Confederate States*, which shall consist of a Senate and House of Representatives.

SECTION 2. The House of Representatives shall be composed of members chosen every second year by the people of the several States; and the electors in each State shall *be citizens of the*

APPENDIX

Qualifications requisite for Electors of the most numerous Branch of the State Legislature.

No Person shall be a Representative who shall not have attained to the Age of twenty-five years, and been seven Years a Citizen of the United States, and who shall not, when elected, be an Inhabitant of that State in which he shall be chosen.

Representatives and direct Taxes shall be apportioned among the several States which may be included within this Union, according to their respective Numbers, which shall be determined by adding to the whole Number of free Persons, including those bound to Service for a term of years, and excluding Indians not taxed, three-fifths of all other Persons. The actual Enumeration shall be made within three Years after the first meeting of the Congress of the United States, and within every subsequent Term of Ten years, in such Manner as they shall by Law direct. The Number of the Representatives shall not exceed one for every thirty Thousand, but each State shall have at Least one representative; and until such enumeration shall be made, the State of New Hampshire shall be entitled to chuse three,

Confederate States, and have the qualifications requisite for electors of the most numerous branch of the State Legislature; *but no person of foreign birth, not a citizen of the Confederate States, shall be allowed to vote for any officer, civil or political, State or Federal.*

No person shall be a Representative who shall not have attained the age of twenty-five years, and *be a citizen of the Confederate States*, and who shall not, when elected, be an inhabitant of that State in which he shall be chosen.

Representatives and direct taxes shall be apportioned among the several States, which may be included within this *Confederacy*, according to their respective numbers, which shall be determined, by adding to the whole number of free persons, including those bound to service for a term of years, and excluding Indians not taxed, three-fifths of all *slaves*. The actual enumeration shall be made within three years after the first meeting of the Congress of the *Confederate States*, and within every subsequent term of ten years, in such manner as they shall by law direct. The number of Representatives shall not exceed one for every *fifty* thousand, but each State shall have at least one Representative; and until such enumeration shall be made, the State of *South Carolina* shall be entitled to choose *six*; *the State of Georgia ten*; *the*

APPENDIX

Massachusetts eight, Rhode Island and Providence Plantations one, Connecticut five, New York six, New Jersey four, Pennsylvania eight, Delaware one, Maryland six, Virginia ten, North Carolina five, South Carolina five, and Georgia three.

When vacancies happen in the Representation from any State, the Executive Authority thereof shall issue Writs of Election to fill such Vacancies.

The House of Representatives shall chuse their Speaker and other officers; and shall have the sole Power of impeachment.

SECTION 3. The Senate of the United States shall be composed of two Senators from each State, chosen by the Legislature thereof, for six Years; and each Senator shall have one Vote.

Immediately after they shall be assembled in Consequence of the first Election, they shall be divided as equally as may be into three Classes. The Seats of the Senators of the first Class shall be vacated at the Expiration of the second Year, of the second Class at the Expiration of the fourth Year, and of the third class at the Expiration of

State of Alabama nine; the State of Florida two; the State of Mississippi seven; the State of Louisiana six; and the State of Texas six.

When vacancies happen in the representation from any State, the Executive authority thereof shall issue writs of election to fill such vacancies.

The House of Representatives shall choose their Speaker and other officers; and shall have the sole power of impeachment; *except that any judicial or other Federal officer, resident and acting solely within the limits of any State, may be impeached by a vote of two-thirds of both branches of the Legislature thereof.*

SECTION 3. The Senate of the *Confederate* States shall be composed of two Senators from each State, chosen for six years by the Legislature thereof, *at the regular session next immediately preceding the commencement of the term of service;* and each Senator shall have one vote.

Immediately after they shall be assembled, in consequence of the first election, they shall be divided as equally as may be into three classes. The seats of the Senators of the first class shall be vacated at the expiration of the second year; of the second class at the expiration of the fourth year; and of the third class at the expiration of the

APPENDIX

the sixth Year, so that one-third may be chosen every second year; and if Vacancies happen by Resignation, or otherwise, during the Recess of the Legislature of any State, the Executive thereof may make temporary Appointments until the next Meeting of the Legislature, which shall then fill such Vacancies.

No person shall be a Senator who shall not have attained to the Age of thirty Years, and been nine Years a citizen of the United States, and who shall not, when elected, be an Inhabitant of that State for which he shall be chosen.

The Vice President of the United States shall be President of the Senate, but shall have no Vote, unless they be equally divided.

The Senate shall chuse their other Officers, and also a President *pro tempore*, in the absence of the Vice President, or when he shall exercise the Office of President of the United States.

The Senate shall have the sole Power to try all Impeachments. When sitting for that Purpose, they shall be on Oath or Affirmation. When the President of the United States is tried, the Chief Justice shall preside: And no Person shall be convicted without the Concurrence of two-thirds of the Members present.

Judgment in Cases of Impeachment shall not extend fur-

sixth year; so that one-third may be chosen every second year; and if vacancies happen by resignation, or otherwise, during the recess of the Legislature of any State, the Executive thereof may make temporary appointments until the next meeting of the Legislature which shall then fill such vacancies.

No person shall be a Senator who shall not have attained the age of thirty years, and *be a citizen of the Confederate States*; and who shall not, when elected, be an inhabitant of *the State* for which he shall be chosen.

The Vice President of the *Confederate States* shall be President of the Senate, but shall have no vote unless they be equally divided.

The Senate shall choose their other officers; and also a President *pro tempore* in the absence of the Vice President, or when he shall exercise the office of President of the *Confederate States*.

The Senate shall have the sole power to try all impeachments. When sitting for that purpose, they shall be on oath or affirmation. When the President of the *Confederate States* is tried, the Chief Justice shall preside; and no person shall be convicted without the concurrence of two-thirds of the members present.

Judgment in cases of impeachment shall not extend further

ther than to removal from Office, and Disqualification to hold and enjoy any Office of Honour, Trust or Profit under the United States: but the party convicted shall nevertheless be liable and subject to Indictment, Trial, Judgment and Punishment, according to Law.

SECTION 4. The Times, Places and Manner of holding Elections for Senators and Representatives, shall be prescribed in each State by the Legislature thereof: but the Congress may at any time by Law make or alter such Regulations, except as to the places of choosing Senators.

The Congress shall assemble at least once in every Year, and such Meeting shall be on the first Monday in December, unless they shall by Law appoint a different Day.

SECTION 5. Each House shall be the Judge of the Elections, Returns and Qualifications of its own Members, and a majority of each shall constitute a Quorum to do Business; but a smaller number may adjourn from day to day, and may be authorized to compel the Attendance of absent Members, in such Manner, and under such Penalties as each House may provide.

Each House may determine the Rules of its Proceedings, punish its Members for disorderly Behaviour, and, with the Concurrence of two-thirds, expel a Member.

than to removal from office, and disqualification to hold and enjoy any office of honor, trust or profit, under the *Confederate States*; but the party convicted shall, nevertheless, be liable and subject to indictment, trial, judgment and punishment according to law.

SECTION 4. The times, places and manner of holding elections for Senators and Representatives, shall be prescribed in each State by the Legislature thereof, *subject to the provisions of this Constitution*; but the Congress may, at any time, by law, make or alter such regulations, except as to the *times* and places of choosing Senators.

The Congress shall assemble at least once in every year; and such meeting shall be on the first Monday in December, unless they shall, by law, appoint a different day.

SECTION 5. Each House shall be the judge of the elections, returns, and qualifications of its own members, and a majority of each shall constitute a quorum to do business; but a smaller number may adjourn from day to day, and may be authorized to compel the attendance of absent members, in such manner and under such penalties as each House may provide.

Each House may determine the rules of its proceedings, punish its members for disorderly behavior, and with the concurrence of two-thirds of the whole number expel a member.

APPENDIX

Each House shall keep a Journal of its Proceedings, and from time to time publish the same, excepting such Parts as may in their judgment require Secrecy; and the Yeas and Nays of the Members of either House on any question shall, at the Desire of one-fifth of those Present, be entered on the Journal.

Neither House, during the Session of Congress, shall, without the Consent of the other, adjourn for more than three days, nor to any other Place than that in which the two Houses shall be sitting.

SECTION 6. The Senators and Representatives shall receive a compensation for their Services, to be ascertained by Law, and paid out of the Treasury of the United States. They shall in all cases, except Treason, Felony and Breach of the Peace, be privileged from Arrest during their Attendance at the Session of their respective Houses, and in going to and returning from the same, and for any Speech or Debate in either House, they shall not be questioned in any other Place.

No Senator or Representative shall, during the time for which he was elected, be appointed to any civil Office under the Authority of the United States, which shall have been created, or the Emoluments whereof shall have been increased during such time; and no Person holding any Office under the United States, shall be a Member of either

Each House shall keep a journal of its proceedings, and from time to time publish the same, excepting such parts as may in their judgment require secrecy; and the yeas and nays of the members of either House, on any question, shall, at the desire of one-fifth of those present, be entered on the journal.

Neither House, during the session of Congress, shall, without the consent of the other, adjourn for more than three days, nor to any other place than that in which the two Houses shall be sitting.

SECTION 6. The Senators and Representatives shall receive a compensation for their services, to be ascertained by law, and paid out of the treasury of the *Confederate* States. They shall, in all cases, except treason, felony, and breach of peace, be privileged from arrest during their attendance at the session of their respective Houses, and in going to and returning from the same; and for any speech or debate in either House, they shall not be questioned in any other place.

No Senator or Representative shall, during the time for which he was elected, be appointed to any civil office under the authority of the *Confederate* States, which shall have been created, or the emoluments whereof shall have been increased during such time; and no person holding any office under the *Confederate* States shall be a member of

APPENDIX

House during his Continuance in Office.

SECTION 7. All Bills for raising Revenue shall originate in the House of Representatives; but the Senate may propose or concur with Amendments as on other Bills.

Every Bill which shall have passed the House of Representatives and the Senate, shall, before it become a Law, be presented to the President of the United States; if he approve, he shall sign it, but if not he shall return it, with his Objections to that House in which it shall have originated, who shall enter the Objections at large on their Journal, and proceed to reconsider it. If after such Reconsideration two-thirds of that House shall agree to pass the Bill, it shall be sent, together with the Objections, to the other House, by which it shall likewise be reconsidered, and if approved by two-thirds of that house, it shall become a Law. But in all such Cases the Votes of Both Houses shall be determined by Yeas and Nays, and the Names of the Persons voting for and against the Bill shall be entered on the Journal of each House respectively. If any Bill shall not be returned

either House during his continuance in office. *But Congress may, by law, grant to the principal officer in each of the Executive Departments a seat upon the floor of either House, with the privilege of discussing any measures appertaining to his department.*

SECTION 7. All bills for raising the revenue shall originate in the House of Representatives; but the Senate may propose or concur with the amendments, as on other bills.

Every bill which shall have passed *both Houses*, shall, before it becomes a law, be presented to the President of the *Confederate States*; if he approve, he shall sign it; but if not, he shall return it, with his objections, to that House in which it shall have originated, who shall enter the objections at large on their journal, and proceed to reconsider it. If, after such reconsideration, two-thirds of that House shall agree to pass the bill, it shall be sent, together with the objections, to the other House, by which it shall likewise be reconsidered, and if approved by two-thirds of that House, it shall become a law. But in all such cases, the votes of both Houses shall be determined by yeas and nays, and the names of the persons voting for and against the bill shall be entered on the journal of each House respectively. If any bill shall not be returned by the President within ten days

APPENDIX

by the President within ten Days (Sundays excepted) after it shall have been presented to him, the Same shall be a law, in like Manner as if he had signed it, unless the Congress by their Adjournment prevent its Return, in which Case it shall not be a Law.

Every Order, Resolution, or Vote, to which the Concurrence of the Senate and House of Representatives may be necessary (except on a question of Adjournment) shall be presented to the President of the United States; and before the Same shall take Effect, shall be approved by him, or being disapproved by him, shall be re-passed by two-thirds of the Senate and House of Representatives, according to the Rules and Limitations prescribed in the Case of a Bill.

SECTION 8. The Congress shall have Power

To lay and collect Taxes, Duties, Imposts and Excises, to pay the Debts and provide for the common Defence and general Welfare of the United States;

(Sundays excepted) after it shall have been presented to him, the same shall be a law, in like manner as if he had signed it, unless the Congress, by their adjournment, prevent its return; in which case it shall not be a law. *The President may approve any appropriation and disapprove any other appropriation in the same bill. In such case he shall, in signing the bill, designate the appropriations disapproved; and shall return a copy of such appropriations, with his objections, to the House in which the bill shall have originated; and the same proceedings shall then be had as in case of other bills disapproved by the President.*

Every order, resolution or vote, to which the concurrence of *both Houses* may be necessary, (except on a question of adjournment,) shall be presented to the President of the *Confederate States*; and, before the same shall take effect, shall be approved by him; or, being disapproved, shall be re-passed by two-thirds of *both Houses*, according to the rules and limitations prescribed in case of a bill.

SECTION 8. The Congress shall have power—

To lay and collect taxes, duties, impost, and excises, *for revenue necessary* to pay the debts, provide for the common defence, *and carry on the government*

APPENDIX

but all Duties, Imposts and Excises shall be uniform throughout the United States;

To borrow Money on the credit of the United States;

To regulate Commerce with foreign Nations, and among the several States, and with the Indian Tribes;

To establish an uniform Rule of Naturalization, and uniform Laws on the subject of Bankruptcies throughout the United States;

To coin Money, regulate the Value thereof, and of foreign Coin, and fix the Standard of Weights and Measures;

To provide for the punishment of counterfeiting the Securities

of the Confederate States; but no bounties shall be granted from the treasury; nor shall any duties or taxes on importations from foreign nations be laid to promote or foster any branch of industry; and all duties, impost, and excises shall be uniform throughout the Confederate States:

To borrow money on the credit of the Confederate States:

To regulate commerce with foreign nations, and among the several States, and with the Indian tribes; *but neither this, nor any other clause contained in the constitution, shall ever be construed to delegate the power to Congress to appropriate money for any internal improvement intended to facilitate commerce; except for the purpose of furnishing lights, beacons, and buoys, and other aids to navigation upon the coasts, and the improvement of harbors and the removing of obstructions in river navigation, in all which cases, such duties shall be laid on the navigation facilitated thereby, as may be necessary to pay the costs and expenses thereof:*

To establish uniform laws of naturalization, and uniform laws on the subject of bankruptcies, throughout the Confederate States; *but no law of Congress shall discharge any debt contracted before the passage of the same:*

To coin money, regulate the value thereof and of foreign coin, and fix the standard of weights and measures:

To provide for the punishment of counterfeiting the securities

APPENDIX

and current Coin of the United States;

To establish Post Offices and post Roads;

To promote the progress of Science and useful Arts, by securing for limited Times to Authors and Inventors the exclusive Right to their respective Writings and discoveries;

To constitute Tribunals inferior to the Supreme Court;

To define and punish Piracies and Felonies committed on the high seas, and Offences against the Law of Nations;

To declare War, grant Letters of Marque and Reprisal, and make Rules concerning Captures on Land and Water;

To raise and support Armies, but no Appropriation of Money to that Use shall be for a longer Term than two Years;

To provide and maintain a Navy;

To make Rules for the Government and Regulation of the land and naval Forces;

To provide for calling forth the Militia to execute the Laws of the Union, suppress Insurrections and repel invasion;

To provide for organizing, arming, and disciplining, the Militia, and for governing such Part of them as may be employed in the Service of the United

and current coin of the *Confederate* States :

To establish post-offices and post routes; *but the expenses of the Post-office Department, after the first day of March in the year of our Lord eighteen hundred and sixty-three, shall be paid out of its own revenue:*

To promote the progress of science and useful arts, by securing for limited times to authors and inventors the exclusive right to their respective writings and discoveries :

To constitute tribunals inferior to the Supreme Court :

To define and punish piracies and felonies committed on the high seas, and offences against the law of nations :

To declare war, grant letters of marque and reprisal, and make rules concerning captures on land and on water :

To raise and support armies; but no appropriation of money to that use shall be for a longer term than two years :

To provide and maintain a navy :

To make rules for the government and regulation of the land and naval forces :

To provide for calling forth the militia to execute the laws of the *Confederate* States, suppress insurrections, and repel invasions :

To provide for organizing, arming, and disciplining the militia, and for governing such part of them as may be employed in the service of the *Confederate* States ;

APPENDIX

States, reserving to the States respectively, the Appointment of the Officers, and the Authority of training the Militia according to the Discipline prescribed by Congress;

To exercise exclusive Legislation in all Cases whatsoever, over such District (not exceeding ten Miles square) as may, by Cession of particular States, and the Acceptance of Congress, become the Seat of the Government of the United States, and to exercise like Authority over all Places purchased by the Consent of the Legislature of the State in which the Same shall be, for the Erection of Forts, Magazines, Arsenals, Dock Yards, and other needful Buildings;—And

To make all Laws which shall be necessary and proper for carrying into Execution the foregoing Powers, and all other Powers vested by this Constitution in the Government of the United States, or in any Department or Officer thereof.

SECTION 9. The Migration or Importation of such Persons as any of the States now existing shall think proper to admit, shall not be prohibited by the Congress prior to the Year one thousand eight hundred and eight, but a Tax or Duty may be imposed on such Importation, not exceeding ten dollars for each Person.

The Privilege of the Writ of

reserving to the States, respectively, the appointment of the officers, and the authority of training the militia according to the discipline prescribed by Congress:

To exercise exclusive legislation, in all cases whatsoever, over such district (not exceeding ten miles square) as may, by cession of *one or more* States and the acceptance of Congress, become the seat of the government of the *Confederate* States: and to exercise like authority over all places purchased by the consent of the legislature of the State in which the same shall be, for the erection of forts, magazines, arsenals, dockyards, and other needful buildings: and

To make all laws which shall be necessary and proper for carrying into execution the foregoing powers, and all other powers vested by this Constitution in the government of the *Confederate* State, or in any department or officer thereof.

SECTION 9. The importation of *negroes of the African race, from any foreign country other than the slaveholding States or Territories of the United States of America, is hereby forbidden; and Congress is required to pass such laws as shall effectually prevent the same.*

Congress shall also have power to prohibit the introduction of slaves from any State not a member of, or Territory not belonging to, this Confederacy.

The privilege of the writ of

APPENDIX

Habeas Corpus shall not be suspended, unless when in Cases of Rebellion or Invasion the public safety may require it.

No Bill of Attainder or ex post facto Law shall be passed.

No Capitation, or other direct Tax shall be laid, unless in Proportion to the Census or Enumeration herein before directed to be taken.

No Tax or Duty shall be laid on Articles exported from any State.

No Preference shall be given by any Regulation of Commerce or Revenue to the Ports of one State over those of another; nor shall Vessels bound to, or from, one State, be obliged to enter, clear, or pay Duties in another.

No Money shall be drawn from the Treasury, but in Consequence of Appropriations made by Law; and a regular Statement and Account of the Receipts and Expenditures of all public Money shall be published from time to time.

habeas corpus shall not be suspended, unless when in case of rebellion or invasion the public safety may require it.

No bill of attainder, *ex post facto* law, or law denying or impa[i]ring the right of property in negro slaves shall be passed.

No capitation or other direct tax shall be laid, unless in proportion to the census or enumeration hereinbefore directed to be taken.

No tax or duty shall be laid on articles exported from any State, *except by a vote of two-thirds of both Houses.*

No preference shall be given by any regulation of commerce or revenue to the ports of one State over those of another.

No money shall be drawn from the treasury, but in consequence of appropriations made by law; and a regular statement and account of the receipts and expenditures of all public money shall be published from time to time.

Congress shall appropriate no money from the treasury, except by a vote of two-thirds of both Houses, taken by yeas and nays, unless it be asked and estimated for by some one of the heads of departments, and submitted to Congress by the President; or for the purpose of paying its own expenses and contingencies; or for the payment of claims against the Confederate States, the justice

APPENDIX

of which shall have been judicially declared by a tribunal for the investigation of claims against the government, which it is hereby made the duty of Congress to establish.

All bills appropriating money shall specify in federal currency the exact amount of each appropriation and the purposes for which it is made; and Congress shall grant no extra compensation to any public contractor, officer, agent or servant, after such contract shall have been made or such service rendered.

No Title of Nobility shall be granted by the United States; and no Person holding any Office of Profit or Trust under them, shall, without the Consent of the Congress, accept of any present, Emolument, Office, or Title, of any kind whatever, from any King, Prince, or foreign State.

No title of nobility shall be granted by the *Confederate* States; and no person holding any office of profit or trust under them shall, without the consent of the Congress, accept of any present, emolument, office or title of any kind whatever, from any king, prince, or foreign state.

Congress shall make no law respecting an establishment of religion, or prohibiting the free exercise thereof; or abridging the freedom of speech, or of the press; or the right of the people peaceably to assemble and petition the government for a redress of grievances.

A well-regulated militia being necessary to the security of a free state, the right of the people to keep and bear arms shall not be infringed.

No soldier shall, in time of peace, be quartered in any house, without the consent of the owner; nor in time of war, but in a manner to be prescribed by law.

APPENDIX

The right of the people to be secure in their persons, houses, papers, and effects, against unreasonable searches and seizures, shall not be violated; and no warrants shall issue but upon probable cause, supported by oath or affirmation, and particularly describing the place to be searched, and the persons or things to be seized.

No person shall be held to answer for a capital or otherwise infamous crime, unless on a presentment or indictment of a grand jury, except in cases arising in the land or naval forces, or in the militia, when in actual service in time of war or public danger; nor shall any person be subject for the same offense, to be twice put in jeopardy of life or limb; nor be compelled, in any criminal case, to be a witness against himself; nor be deprived of life, liberty, or property without due process of law; nor shall private property be taken for public use, without just compensation.

In all criminal prosecutions, the accused shall enjoy the right to a speedy and public trial, by an impartial jury of the State and district wherein the crime shall have been committed, which district shall have been previously ascertained by law, and to be informed of the nature and cause of the accusation; to be confronted with the witnesses against him; to have compulsory process for obtaining witnesses in his favor; and to have the assistance of counsel for his defence.

APPENDIX

In suits at common law, where the value in controversy shall exceed twenty dollars, the right of trial by jury shall be preserved; and no fact so tried by a jury shall be otherwise re-examined in any court of the *Confederacy*, than according to the rules of common law.

Excessive bail shall not be required, nor excessive fines imposed, nor cruel and unusual punishment inflicted.

Every law, or resolution having the force of law, shall relate to but one subject, and that shall be expressed in the title.

SECTION 10. No State shall enter into any Treaty, Alliance, or Confederation: grant Letters of Marque and Reprisal; coin money; emit Bills of Credit; make any Thing but gold and silver Coin a Tender in Payment of Debts; pass any Bill of Attainder, ex post facto Law, or Law impairing the Obligation of Contracts, or grant any Title of Nobility.

No State shall, without the Consent of the Congress, lay any Imposts or Duties on Imports or Exports, except what may be absolutely necessary for executing its inspection Laws; and the net Produce of all Duties and Imposts, laid by any State on Imports or Exports, shall be for the Use of the Treasury of the United States; and all such Laws shall be subject to the Revision and Controul of the Congress.

No State shall, without the

SECTION 10. No State shall enter into any treaty, alliance, or confederation; grant letters of marque and reprisal; coin money; make any thing but gold and silver coin a tender in payment, of debts; pass any bill of attainder, or *ex post facto* law, or law impairing the obligation of contracts; or grant any title of nobility.

No State shall, without the consent of the Congress, lay any impost or duties on imports or exports, except what may be absolutely necessary for executing its inspection laws; and the nett produce of all duties and impost, laid by any State on imports or exports, shall be for the use of the Treasury of the *Confederate* States; and all such laws shall be subject to the revision and control of Congress.

No State shall, without the

APPENDIX

Consent of Congress, lay any Duty of Tonnage, keep Troops, or Ships of War in time of Peace, enter into any Agreement or Compact with another State, or with a foreign Power, or engage in War, unless actually invaded, or in such imminent Danger as will not admit of Delay.

consent of Congress, lay any duty on tonnage, *except on sea-going vessels, for the improvement of its rivers and harbors navigated by the said vessels; but such duties shall not conflict with any treaties of the Confederate States with foreign nations; and any surplus revenue thus derived, shall, after making such improvement, be paid into the common treasury. Nor shall any State keep troops or ships-of-war in time of peace, enter into any agreement or compact with another State, or with a foreign power, or engage in war, unless actually invaded, or in such imminent danger as will not admit of delay. But when any river divides or flows through two or more States, they may enter into compacts with each other to improve the navigation thereof*

ARTICLE II.

SECTION I. The executive Power shall be vested in a President of the United States of America. He shall hold his Office during the Term of four Years, and, together with the Vice President, chosen for the same Term, be elected, as follows:

Each State shall appoint, in such Manner as the Legislature thereof may direct, a Number of Electors, equal to the whole number of Senators and Representatives to which the State may be entitled in the Congress: but no Senator or Representative, or Person holding an Office

ARTICLE II.

SECTION I. The executive power shall be vested in a President of the *Confederate States of America. He and the Vice President shall hold their offices for the term of six years; but the President shall not be re-eligible. The President and the Vice President shall be elected as follows:*

Each State shall appoint, in such manner as the legislature thereof may direct, a number of electors equal to the whole number of Senators and Representatives to which the State may be entitled in the Congress; but no Senator or Representative or person holding an office of trust

APPENDIX

of Trust or Profit under the United States, shall be appointed an Elector.

The Electors shall meet in their respective States, and vote by Ballot for two Persons, of whom one at least shall not be an Inhabitant of the same State with themselves. And they shall make a List of all the Persons voted for, and of the Number of Votes for each; which List they shall sign and certify, and transmit sealed to the Seat of the Government of the United States, directed to the president of the Senate. The President of the Senate shall, in the Presence of the Senate and House of Representatives, open all the Certificates and the Votes shall then be counted. The Person having the greatest Number of Votes shall be the President, if such Number be a Majority of the whole Number of Electors appointed; and if there be more than one who have such Majority and have an equal Number of Votes, then the House of Representatives shall immediately chuse by Ballot one of them for President; and if no Person have a Majority, then from the five highest on the List the said House shall in like Manner chuse the President. But in chusing the President, the Votes shall be taken by States, the Representation from each State having one Vote; a Quorum for this Purpose shall consist of a Member or Members from two thirds of the States,

or profit under the *Confederate* States, shall be appointed an elector.

The electors shall meet in their respective States and vote by ballot for President and Vice President, one of whom, at least, shall not be an inhabitant of the same State with themselves; they shall name in their ballots the person voted for as President, and in distinct ballots the person voted for as Vice President, and they shall make distinct lists of all persons voted for as President, and all persons voted for as Vice President, and of the number of votes for each, which list they shall sign and certify, and transmit, sealed, to the seat of the government of the *Confederate* States, directed to the President of the Senate; the President of the Senate shall, in the presence of the Senate and House of Representatives, open all the certificates, and the votes shall then be counted: the person having the greatest number of votes for President shall be the President, if such number be a majority of the whole number of electors appointed; and if no person have such a majority, then, from the persons having the highest numbers, not exceeding three, on the list of those voted for as President, the House of Representatives shall choose immediately, by ballot, the President. But in choosing the President, the votes shall be taken by States—the representation from each State having one vote; a quorum

APPENDIX

and a Majority of all the States shall be necessary to a Choice. In every Case, after the Choice of the President, the Person having the greatest Number of Votes of the Electors shall be the Vice President, but if there should remain two or more who have equal Votes, the Senate shall chuse from them by Ballot the Vice-President.

for this purpose shall consist of a member or members from two-thirds of the States, and a majority of all the States shall be necessary to a choice. And if the House of Representatives shall not choose a President, whenever the right of choice shall devolve upon them, before the fourth day of March next following, then the Vice President shall act as President, as in the case of the death, or other constitutional disability of the President.

The person having the greatest number of votes as Vice President, shall be the Vice President, if such number be a majority of the whole number of electors appointed; and if no person have a majority, then, from the two highest numbers on the list, the Senate shall choose the Vice President; a quorum for the purpose shall consist of two-thirds of the whole number of Senators, and a majority of the whole number shall be necessary to a choice.

But no person constitutionally ineligible to the office of President shall be eligible to that of Vice President of the *Confederate States*.

The Congress may determine the Time of chusing the Electors, and the Day on which they shall give their Votes; which Day shall be the same throughout the United States.

No person except a natural-born Citizen, or a Citizen of the United States, at the time of the Adoption of this Constitution,

The Congress may determine the time of choosing the electors, and the day on which they shall give their votes; which day shall be the same throughout the *Confederate States*.

No person except a natural born citizen of the *Confederate States*, or a citizen thereof at the time of the adoption of this

APPENDIX

shall be eligible to the Office of President; neither shall any Person be eligible to that Office who shall not have attained to the age of thirty five Years, and been fourteen Years a Resident within the United States.

In Case of the Removal of the President from Office, or of his Death, Resignation, or Inability to discharge the Powers and Duties of the said office, the same shall devolve on the Vice President, and the Congress may by Law provide for the Case of Removal, Death, Resignation, or Inability, both of the President and Vice President, declaring what Officer shall then act as President, and such Officer shall act accordingly, until the Disability be removed, or a President shall be elected.

The President shall, at stated Times, receive for his Services, a Compensation, which shall neither be increased nor diminished during the Period for which he shall have been elected, and he shall not receive within that Period any other Emolument from the United States, or any of them.

Before he enter on the Execution of his Office, he shall take the following Oath or Affirmation:

“I do solemnly swear (or Affirm) that I will faithfully

Constitution, or a citizen thereof born in the United States prior to the 20th of December, 1860, shall be eligible to the office of President; neither shall any person be eligible to that office who shall not have attained the age of thirty-five years, and been fourteen years a resident within the *limits of the Confederate States, as they may exist at the time of his election.*

In case of the removal of the President from office, or of his death, resignation, or inability to discharge the powers and duties of the said office, the same shall devolve on the Vice President; and the Congress may, by law, provide for the case of removal, death, resignation, or inability, both of the President and Vice President, declaring what officer shall then act as President; and such officer shall act accordingly, until the disability be removed or a President shall be elected.

The President shall, at stated times, receive for his services a compensation, which shall neither be increased nor diminished during the period for which he shall have been elected; and he shall not receive within that period any other emolument from the *Confederate States*, or any of them.

Before he enters on the execution of his office, he shall take the following oath or affirmation:

“I do solemnly swear (or affirm) that I will faithfully execute the

APPENDIX

“execute the Office of President
“of the United States, and will
“to the best of my Ability, pre-
“serve, protect and defend the
“Constitution of the United
“States.”

SECTION 2. The President shall be Commander in Chief of the Army and Navy of the United States, and of the Militia of the several States, when called into the actual Service of the United States; he may require the Opinion, in writing, of the principal Officer in each of the executive Departments, upon any subject relating to the Duties of their respective Offices, and he shall have Power to grant Reprieves and Pardons for Offences against the United States, except in Cases of Impeachment.

He shall have Power, by and with the Advice and Consent of the Senate, to make Treaties, provided two thirds of the Senators present concur; and he shall nominate, and by and with the Advice and Consent of the Senate, shall appoint Ambassadors, other public Ministers and Consuls, Judges of the supreme Court, and all other Officers of the United States, whose Appointments are not herein otherwise provided for, and which shall be established by Law; but the Congress may by Law vest the Appointment of such inferior Officers, as they think proper, in the President alone, in the Courts of Law, or in the Heads of Departments.

office of President of the *Confederate* States, and will, to the best of my ability, preserve, protect, and defend the Constitution thereof.”

SECTION 2. The President shall be commander-in-chief of the army and navy of the *Confederate* States, and of the militia of the several States, when called into the actual service of the *Confederate* States; he may require the opinion, in writing, of the principal officer in each of the executive departments, upon any subject relating to the duties of their respective offices; and he shall have power to grant reprieves and pardons for offences against the *Confederate* States, except in cases of impeachment.

He shall have power, by and with the advice and consent of the Senate, to make treaties; provided two-thirds of the Senators present concur; and he shall nominate, and by and with the advice and consent of the Senate, shall appoint ambassadors, other public ministers and consuls, judges of the Supreme Court, and all other officers of the *Confederate* States whose appointments are not herein otherwise provided for, and which shall be established by law; but the Congress may, by law, vest the appointment of such inferior officers, as they think proper, in the President alone, in the courts of law, or in the heads of departments.

APPENDIX

The principal officer in each of the executive departments, and all persons connected with the diplomatic service, may be removed from office at the pleasure of the President. All other civil officers of the executive department may be removed at any time by the President, or other appointing power, when their services are unnecessary, or for dishonesty, incapacity, inefficiency, misconduct, or neglect of duty; and when so removed, the removal shall be reported to the Senate, together with the reasons therefor.

The President shall have the Power to fill all Vacancies that may happen during the Recess of the Senate, by granting Commission which shall expire at the End of their next Session.

SECTION 3. He shall from time to time give to the Congress Information of the State of the Union, and recommend to their Consideration such Measures as he shall judge necessary and expedient; he may, on extraordinary Occasions, convene both Houses, or either of them, and in Case of Disagreement between them, with Respect to the time of Adjournment, he may adjourn them to such Time as he shall think proper; he shall receive Ambassadors and other public Ministers; he shall take Care that the Laws be faithfully executed, and shall Commission

The President shall have power to fill all vacancies that may happen during the recess of the Senate, by granting commissions which shall expire at the end of their next session; but no person rejected by the Senate shall be reappointed to the same office during their ensuing recess.

SECTION 3. *The President shall, from time to time, give to the Congress information of the state of the Confederacy, and recommend to their consideration such measures as he shall judge necessary and expedient; he may, on extraordinary occasions, convene both Houses, or either of them; and in case of disagreement between them, with respect to the time of adjournment, he may adjourn them to such time as he shall think proper; he shall receive ambassadors and other public ministers; he shall take care that the laws be faithfully executed, and shall com-*

APPENDIX

all the officers of the United States.

SECTION 4. The President, Vice President and all civil Officers of the United States shall be removed from Office on Impeachment for, and Conviction of, Treason, Bribery, or other high Crimes and Misdemeanors.

ARTICLE III.

SECTION 1. The Judicial Power of the United States, shall be vested in one supreme Court, and in such inferior Courts as the Congress may from time to time ordain and establish. The Judges, both of the supreme and inferior Courts, shall hold their offices during good Behavior, and shall, at stated times, receive for their Services a Compensation which shall not be diminished during their Continuance in Office.

SECTION 2. The Judicial Power shall extend to all Cases, in Law and Equity, arising under this Constitution, the Laws of the United States and Treaties made, or which shall be made under their Authority;—to all Cases affecting Ambassadors, other public Ministers and Consuls;—to all Cases of admiralty and maritime Jurisdiction;—to Controversies to which the United States shall be a Party;—to Controversies between two or more States;—between a State and Citizens of another State;—between Citizens of different States, between Citizens of the

mission all the officers of the *Confederate* States.

SECTION 4. The President, Vice President, and all civil officers of the *Confederate* States, shall be removed from office on impeachment, for and conviction of, treason, bribery, or other high crimes and misdemeanors.

ARTICLE III.

SECTION 1. The judicial power of the *Confederate* States shall be vested in one Supreme Court, and in such inferior courts as the Congress may, from time to time, ordain and establish. The judges, both of the Supreme and inferior courts, shall hold their offices during good behavior, and shall, at stated times, receive for their services a compensation which shall not be diminished during their continuance in office.

SECTION 2. The judicial power shall extend to all cases arising under this Constitution, the laws of the *Confederate* States, and treaties made, or which shall be made, under their authority; to all cases affecting ambassadors, other public ministers and consuls; to all cases of admiralty and maritime jurisdiction; to controversies to which the *Confederate* States shall be a party; to controversies between two or more States; between a State and citizens of another State, *where the State is plaintiff*; between citizens claiming lands under grants of different States;

APPENDIX

same State claiming Lands under Grants of different States and between a State, or the Citizens thereof, and foreign States, Citizens or Subjects.

In all Cases affecting Ambassadors, other public Ministers and Consuls, and those in which a State shall be Party, the supreme Court shall have original Jurisdiction. In all the other Cases before mentioned, the supreme Court shall have appellate Jurisdiction, both as to Law and Fact, with such Exceptions, and under such Regulations as the Congress shall make.

The Trial of all Crimes, except Cases of Impeachment, shall be by Jury; and such Trial shall be held in the State where the said Crimes shall have been committed; but when not committed within any State, the Trial shall be at such Place or Places as the Congress may by Law have directed.

SECTION 3. Treason against the United States, shall consist only in levying War against them, or in adhering to their enemies, giving them Aid and Comfort. No Person shall be convicted of Treason unless on the Testimony of two Witnesses to the same overt Act, or on Confession in open Court.

The Congress shall have Power to declare the Punishment of Treason, but no Attainder of Treason shall work corruption of Blood, or Forfeiture except during the Life of the Person attained.

and between a State or the citizens thereof, and foreign states, citizens or subjects. *But no State shall be sued by a citizen or subject of any foreign state.*

In all cases affecting ambassadors, other public ministers and consuls, and those in which a State shall be a party, the Supreme Court shall have original jurisdiction. In all the other cases before mentioned, the Supreme Court shall have appellate jurisdiction both as to law and fact, with such exceptions and under such regulations as the Congress shall make.

The trial of all crimes, except in cases of impeachment, shall be by jury, and such trial shall be held in the State where the said crimes shall have been committed; but when not committed within any State, the trial shall be at such place or places as the Congress may by law have directed.

SECTION 3. Treason against the *Confederate* States shall consist only in levying war against them, or in adhering to their enemies, giving them aid and comfort. No person shall be convicted of treason unless on the testimony of two witnesses to the same overt act, or on confession in open court.

The Congress shall have power to declare the punishment of treason; but no attainder of treason shall work corruption of blood, or forfeiture, except during the life of the person attained.

APPENDIX

ARTICLE IV.

SECTION 1. Full Faith and Credit shall be given in each State to the public Acts, Records, and judicial Proceedings of every other State. And the Congress may by general Laws prescribe the Manner in which such Acts, Records and Proceedings shall be proved, and the Effect thereof.

SECTION 2. The Citizens of each State shall be entitled to all Privileges and Immunities of Citizens in the several States.

A Person charged in any State with Treason, Felony, or other Crime, who shall flee from Justice, and be found in another State, shall on Demand of the executive Authority of the State from which he fled, be delivered up, to be removed to the State having Jurisdiction of the Crime.

No Person held to Service or Labour in one State, under the Laws thereof, escaping into another, shall, in Consequence of any Law or Regulation therein, be discharged from such Service or Labour, but shall be delivered up on Claim of the Party to whom such Service or Labour may be done.

ARTICLE IV.

SECTION 1. Full faith and credit shall be given in each State to the public acts, records, and judicial proceedings of every other State. And the Congress may, by general laws, prescribe the manner in which such acts, records, and proceedings shall be proved, and the effect thereof.

SECTION 2. The citizens of each State shall be entitled to all the privileges and immunities of citizens in the several States; *and shall have the right of transit and sojourn in any State of this Confederacy, with their slaves and other property; and the right of property in said slaves shall not be thereby impaired.*

A person charged in any State with treason, felony, or other crime *against the laws of such State*, who shall flee from justice, and be found in another State, shall, on demand of the Executive authority of the State from which he fled, be delivered up, to be removed to the State having jurisdiction of the crime.

No slave or other person held to service or labor in any State or Territory of the Confederate States, under the laws thereof, escaping *or lawfully carried* into another, shall, in consequence of any law or regulation therein, be discharged from such service or labor: but shall be delivered up on claim of the party *to whom such slave belongs*, or to whom

APPENDIX

SECTION 3. New States may be admitted by the Congress into this Union; but no new State shall be formed or erected within the Jurisdiction of any other State; nor any State be formed by the Junction of two or more States, or Parts of States, without the Consent of the Legislatures of the States concerned as well as of the Congress.

The Congress shall have power to dispose of and make all needful Rules and Regulations respecting the Territory or other Property belonging to the United States; and nothing in this Constitution shall be so construed as to Prejudice any Claims of the United States, or of any particular State.

such service or labor may be due.

SECTION 3. *Other States may be admitted into this Confederacy by a vote of two-thirds of the whole House of Representatives and two-thirds of the Senate, the Senate voting by States; but no new State shall be formed or erected within the jurisdiction of any other State; nor any State be formed by the junction of two or more States, or parts of States, without the consent of the legislatures of the States concerned, as well as of the Congress.*

The Congress shall have power to dispose of and make all needful rules and regulations concerning the property of the Confederate States, including the lands thereof.

The Confederate States may acquire new territory; and Congress shall have power to legislate and provide governments for the inhabitants of all territory belonging to the Confederate States, lying without the limits of the several States; and may permit them at such times and in such manner as it may by law provide, to form States to be admitted into the Confederacy. In all such territory, the institution of negro slavery, as it now exists in the Confederate States, shall be recognized and protected by Congress and by the territorial government. and the inhabitants of the several Confederate States and Territories shall have the right to take to such territory any slaves lawfully held by them in any

APPENDIX

SECTION 4. The United States shall guarantee to every State in this Union a Republican Form of Government, and shall protect each of them against Invasion, and on Application of the Legislature, or of the Executive (when the Legislature cannot be convened) against domestic Violence.

ARTICLE V.

The Congress, whenever two-thirds of both Houses shall deem it necessary, shall propose Amendments to this Constitution, or on the application of the Legislatures of two-thirds of the several States, shall call a Convention for proposing Amendments, which, in either Case, shall be valid to all Intents and Purposes, as Part of this Constitution, when ratified by the Legislatures of three fourths of the several States, or by Conventions in three fourths thereof, as the one or the other Mode of Ratification may be proposed by the Congress: Provided that no Amendment which may be made prior to the Year one thousand eight hundred and eight shall in any Manner affect the first and fourth Clauses in the Ninth Section of the first Article, and that no State, without its Consent, shall be deprived of its equal suffrage in the Senate.

of the States or Territories of the Confederate States.

The *Confederate States* shall guarantee to every State *that now is, or hereafter may become, a member of this Confederacy*, a republican form of government; and shall protect each of them against invasion; and on application of the legislature (or of the executive, when the legislature *is not in session*), against domestic violence.

ARTICLE V.

SECTION 1. *Upon the demand of any three States, legally assembled in their several conventions, the Congress shall summon a convention of all the States, to take into consideration such amendments to the Constitution as the said States shall concur in suggesting at the time when the said demand is made; and should any of the proposed amendments to the Constitution be agreed on by the said convention—voting by States—and the same be ratified by the legislatures of two-thirds of the several States, or by conventions in two-thirds thereof—as the one or the other mode of ratification may be proposed by the general convention—they shall thenceforward form a part of this Constitution. But no State shall, without its consent, be deprived of its equal representation in the Senate.*

APPENDIX

ARTICLE VI.

All Debts contracted and Engagements entered into, before the Adoption of this Constitution, shall be as valid against the United States under this Constitution, as under the Confederation.

This Constitution, and the Laws of the United States which shall be made in Pursuance thereof; and all Treaties made, or which shall be made, under the authority of the United States, shall be the supreme Law of the Land; and the Judges in every State shall be bound thereby, any Thing in the Constitution or Laws of any State to the contrary notwithstanding.

The Senators and Representatives before mentioned, and the Members of the several State Legislatures, and all executive and judicial Officers both of the United States and of the several States, shall be bound by Oath, or Affirmation, to support this Constitution; but no religious Test shall ever be required as a Qualification to any Office or public Trust under the United States.

ARTICLE VI.

The Government established by this Constitution is the successor of the Provisional Government of the Confederate States of America, and all the laws passed by the latter shall continue in force until the same shall be repealed or modified; and all the officers appointed by the same shall remain in office until their successors are appointed and qualified, or the offices abolished.

All debts contracted and engagements entered into before the adoption of this Constitution shall be as valid against the *Confederate States* under this Constitution as under the *Provisional Government*.

This Constitution, and the laws of the *Confederate States* made in pursuance thereof, and all treaties made, or which shall be made, under the authority of the *Confederate States*, shall be the supreme law of the land; and the judges in every State shall be bound thereby, anything in the Constitution or laws of any State to the contrary notwithstanding.

The Senators and Representatives before mentioned, and the members of the several State legislatures, and all executive and judicial officers, both of the *Confederate States* and of the several States, shall be bound by oath or affirmation to support this Constitution; but no religious test shall ever be required as a qualification to any office or public trust under the *Confederate States*.

APPENDIX

The enumeration, in the Constitution, of certain rights, shall not be construed to deny or disparage others retained by the people *of the several States*.

The powers not delegated to the *Confederate States* by the Constitution, nor prohibited by it to the States, are reserved to the States, respectively, or to the people *thereof*.

ARTICLE VII.

The Ratification of the Conventions of nine States, shall be sufficient for the Establishment of this Constitution between the States so ratifying the Same.

ARTICLE VII.

The ratification of the conventions of *five States* shall be sufficient for the establishment of this Constitution between the States so ratifying the same.

When five States shall have ratified this Constitution, in the manner before specified, the Congress under the Provisional Constitution shall prescribe the time for holding the election of President and Vice President; and for the meeting of the Electoral College; and for counting the votes, and inaugurating the President. They shall, also, prescribe the time for holding the first election of members of Congress under this Constitution, and the time for assembling the same. Until the assembling of such Congress, the Congress under the Provisional Constitution shall continue to exercise the legislative powers granted them; not extending beyond the time limited by the Constitution of the Provisional Government.

APPENDIX

DONE in Convention by the Unanimous Consent of the States present the Seventeenth Day of September in the Year of our Lord one thousand seven hundred and Eighty seven and of the Independence of the United States of America the Twelfth. IN WITNESS whereof We have hereunto subscribed our Names,

GEO WASHINGTON—
Presidt and deputy from Virginia

ADOPTED unanimously by the Congress of the Confederate States of South Carolina, Georgia, Florida, Alabama, Mississippi, Louisiana and Texas, sitting in Convention at the capitol in the city of Montgomery, Alabama, on the Eleventh day of March, in the year Eighteen Hundred and Sixty-One.

HOWELL COBB,
President of the Congress.

New Hampshire.

JOHN LANGDON,
NICHOLAS GILMAN.

Massachusetts.

NATHANIEL GORHAM,
RUFUS KING.

Connecticut.

WM. SAML. JOHNSON,
ROGER SHERMAN.

New York.

ALEXANDER HAMILTON.

New Jersey.

WIL : LIVINGSTON,
WM. PATERSON,
DAVID BREARLEY,
JONA. DAYTON.

Pennsylvania.

B. FRANKLIN,
ROBT. MORRIS,
THO : FITZSIMONS,
JAMES WILSON,
THOMAS MIFFLIN,
GEO : CLYMER,
JARED INGERSOLL
GOUV : MORRIS.

Delaware.

GEO : READ,
JOHN DICKINSON,

South Carolina.

R. BARNWELL RHETT,
C. G. MEMMINGER,
WM. PORCHER MILES,
JAMES CHESNUT, JR.,
R W. BARNWELL,
WILLIAM W. BOYCE,
LAWRENCE M. KEITT,
T. J. WITHERS.

Georgia.

FRANCIS S. BARTOW,
MARTIN J. CRAWFORD,
BENJAMIN H. HILL,
THOS. R. R. COBB.

Florida.

JACKSON MORTON,
J. PATTON ANDERSON,
JAMES B. OWENS.

Alabama.

RICHARD W. WALKER,
ROBT. H. SMITH,
COLIN J. McRAE,
WILLIAM P. CHILTON,
STEPHEN F. HALE,
DAVID P. LEWIS,
THO. FEARN,
JNO. GILL SHORTER,
J. L. M. CURRY.

APPENDIX

JACO : BROOM,
 GUNNING BEDFORD, Jun'r,
 RICHARD BASSETT.

Maryland.

JAMES M'HENRY,
 DAN : OF ST. THOS. JENIFER,
 DANL. CARROLL.

Virginia.

JOHN BLAIR,
 JAMES MADISON, Jr.

North Carolina.

WM. BLOUNT,
 RICH'D DOBBS SPAIGHT,
 HU. WILLIAMSON.

South Carolina.

J. RUTLEDGE,
 CHARLES COTESWORTH
 PINCKNEY,
 CHARLES PINCKNEY,
 PIERCE BUTLER.

Georgia.

WILLIAM FEW,
 ABR. BALDWIN.

Attest :

WILLIAM JACKSON,
Secretary.

Mississippi.

ALEX. M. CLAYTON,
 JAMES T. HARRISON,
 WILLIAM S. BARRY,
 W. S. WILSON,
 WALKER BROOKE,
 W. P. HARRIS,
 J. A. P. CAMPBELL.

Louisiana.

ALEX. DE CLOUET,
 C. M. CONRAD,
 DUNCAN F. KENNER,
 HENRY MARSHALL.

Texas.

JOHN HEMPHILL,
 THOMAS N. WAUL,
 JOHN H. REAGAN,
 WILLIAMSON S. OLDHAM,
 LOUIS T. WIGFALL,
 JOHN GREGG,
 WILLIAM BECK OCHILTREE.

EXTRACT FROM THE JOURNAL OF THE CONGRESS.

CONGRESS, March 11, 1861.

On the question of the adoption of the Constitution of the Confederate States of America. the vote was taken by yeas and nays ; and the Constitution was unanimously adopted, as follows :

Those who voted in the affirmative being Messrs. Walker, Smith, Curry, Hale, McRae, Shorter, and Fearn, of Alabama, (Messrs. Chilton and Lewis being absent) ; Messrs. Morton, Anderson, and Owens, of Florida ; Messrs. Toombs, Howell Cobb,

APPENDIX

Bartow, Nisbet, Hill, Wright, Thos. R. R. Cobb, and Stephens, of Georgia, (Messrs. Crawford and Kenan being absent); Messrs. Perkins, de Clouet, Conrad, Kenner, Sparrow, and Marshall, of Louisiana; Messrs. Harris, Brooke, Wilson, Clayton, Barry, and Harrison, of Mississippi, (Mr. Campbell being absent); Messrs. Rhett, Barnwell, Keitt, Chesnut, Memminger, Miles, Withers, and Boyce, of South Carolina; Messrs. Reagan, Hemphill, Waul, Gregg, Oldham, and Ochiltree, of Texas, (Mr. Wigfall being absent).

A true copy:

J. J. HOOPER,
Secretary of the Congress.

CONGRESS, March 11, 1861.

I do hereby certify that the foregoing are, respectively, true and correct copies of "The Constitution of the Confederate States of America," unanimously adopted this day, and of the yeas and nays on the question of the adoption thereof.

HOWELL COBB,
President of the Congress.





